Contains pages for the

Operating Manual

for

DIGITAL RF SIGNAL GENERATORS 3410 Series

**Part number 46882/499
Issue 13**

Creation date 8-Dec-05

Please open and fit to the supplied Ring Binder

DIGITAL RF SIGNAL GENERATORS

3410 Series

3412	250 kHz–2.0 GHz
3413	250 kHz–3.0 GHz
3414	250 kHz–4.0 GHz
3416	250 kHz–6.0 GHz

This manual applies to instruments with software issues of 4.00 and higher.
Some of the features shown in this manual may not be available
on instruments with earlier versions of software.

© Aeroflex International Ltd. 2005

*No part of this document may be reproduced or transmitted in any form
or by any means, electronic or mechanical, including photocopying,
or recorded by any information storage or retrieval system,
without permission in writing by Aeroflex International Ltd.
(hereafter referred to throughout the document as 'Aeroflex').*

Printed in the UK

Document part no. 46882/499
Issue 13

8 December 2005

About this manual

This manual explains how to use the 3410 Series Digital RF Signal Generators.

Intended audience

Users who need an agile signal generator combining wide frequency cover with high performance vector modulation.

Structure

Chapter 1	Introduction and performance data	Tab 1
Chapter 2	Installation details	Tab 2
Chapter 3	Operation	Tab 3
Chapter 4	Remote operation	Tab 4
Chapter 5	Brief technical description	Tab 5
Chapter 6	Operational verification testing	Tab 6
Index		Tab 7

Associated documentation

The following documentation covers specific aspects of this equipment:

Safety Information	Part no. 46882/502	Supplement providing safety information relevant to your instrument. Also contains a declaration of conformity.
Operating Guide CD-ROM	Part no. 46886/015	Compilation containing this operating manual, IQCreator ® software, waveform files, soft front panel, driver, application notes, data sheet and other information.
IQCreator® Getting Started Manual	Part no. 46882/599	Introduction to using the IQCreator ® software, which allows you to create and package ARB files for 3410 Series signal generators.
IQCreator® User Guide	Part no. 46882/627	Detailed information on using IQCreator ® software, including user files and different modulation schemes.
Service Manual	Part no. 46880/111.	Consists of Operating Manual (this document), Maintenance Manual (part no. 46882/500, provides servicing and fault finding information to module replacement level), CDROM with PDFs of manuals and adjustment and diagnostic software.

Contents

	About this manual	ii
	Preface.....	iv
Chapter 1	GENERAL INFORMATION.....	1-1
Chapter 2	INSTALLATION	2-1
Chapter 3	LOCAL OPERATION.....	3-1
	GETTING STARTED.....	3-11
	DETAILED OPERATION	3-21
	UTILITIES	3-131
Chapter 4	REMOTE OPERATION	4-1
	REMOTE OPERATION COMMANDS.....	4-3
	CONVENTIONS USED IN THIS MANUAL.....	4-4
	Common commands	4-11
	Output control commands	4-17
	Reference oscillator commands.....	4-27
	The [SOURce] subsystem — an introduction	4-31
	RF output frequency commands.....	4-33
	List commands.....	4-41
	AM commands.....	4-49
	Burst commands.....	4-61
	Frequency hopping commands.....	4-75
	FM commands	4-81
	IQ commands	4-93
	IQ commands — ARB subsystem	4-105
	IQ commands — DM subsystem	4-113
	IQ commands — DM:Tones subsystem.....	4-119
	IQ commands — DM:Generic subsystem	4-123
	Phase modulation commands	4-133
	Pulse modulation commands	4-145
	Power commands.....	4-147
	Sweep commands.....	4-157
	Instrument system-level commands	4-161
	Measurement unit commands	4-171
	Calibration commands.....	4-173
	Diagnostic commands.....	4-177
	Display commands.....	4-185
	Virtual front panel commands	4-189
	Status commands.....	4-195
Chapter 5	BRIEF TECHNICAL DESCRIPTION	5-1
Chapter 6	OPERATIONAL VERIFICATION TESTING.....	6-1
Index	I-1

Preface

Patent protection

The 3410 Series digital RF signal generators are protected by the following patents:

GB	2140232
	2214012
	2294599
	2246887
US	4609881
	4870384
	5781600
	5079522
EP	0125790
	0322139
	0423941

Abbreviations

ACP	Adjacent Channel Power
ADC	Analog-to-Digital Converter
ALC	Automatic Level Control
AM	Amplitude Modulation
ARB	Arbitrary Waveform Generator
ATE	Automatic Test Equipment
BFO	Beat Frequency Oscillator
BT	Bandwidth-Time product
CPLD	Complex Programmable Logic Device
CPU	Central Processing Unit
CW	Continuous Wave
DAC	Digital-to-Analog Converter
dB	Decibels
dBc	Decibels relative to the carrier level
dBm	Decibels relative to 1 mW
DHCP	Dynamic Host Configuration Protocol
DM	Digital Modulation
DPSK	Differential Phase Shift Keying
DSP	Digital Signal Processor
DUT	Device Under Test
DVM	Digital Voltmeter
EMF	Electromotive Force
EOI	End Or Identify (GPIB)
EVM	Error Vector Magnitude
FM	Frequency Modulation
FPGA	Field Programmable Gate Array
FSK	Frequency Shift Keying
GPIB	General Purpose Interface Bus
GUI	Graphical User Interface
IF	Intermediate Frequency
IM	Intermodulation
IQ	In-phase/Quadrature
LAN	Local Area Network
LED	Light-Emitting Diode
LO	Local Oscillator
LVDS	Low-Voltage Differential Signaling
OCXO	Oven-Controlled Crystal Oscillator
PD	Potential Difference
PLL	Phase-Locked Loop
PM	Phase Modulation
PN	Pseudo Noise
PRBS	Pseudo-Random Binary Sequence
PSK	Phase Shift Keying
QAM	Quadrature Amplitude Modulation
r	Modulation Rate
RF	Radio Frequency
RMS	Root Mean Square
RPP	Reverse Power Protection
RTBB	Real-Time Baseband
SCPI	Standard Commands for Programmable Instruments
USB	Universal Serial Bus
UUT	Unit Under Test
VA	Volt-Amps
VCO	Voltage-Controlled Oscillator
VSWR	Voltage Standing-Wave Ratio
VTF	Voltage-Tuned Filter



Chapter 1

GENERAL INFORMATION

Contents

Introduction.....	1-1
Performance data.....	1-4
Options.....	1-22
Versions and accessories.....	1-23

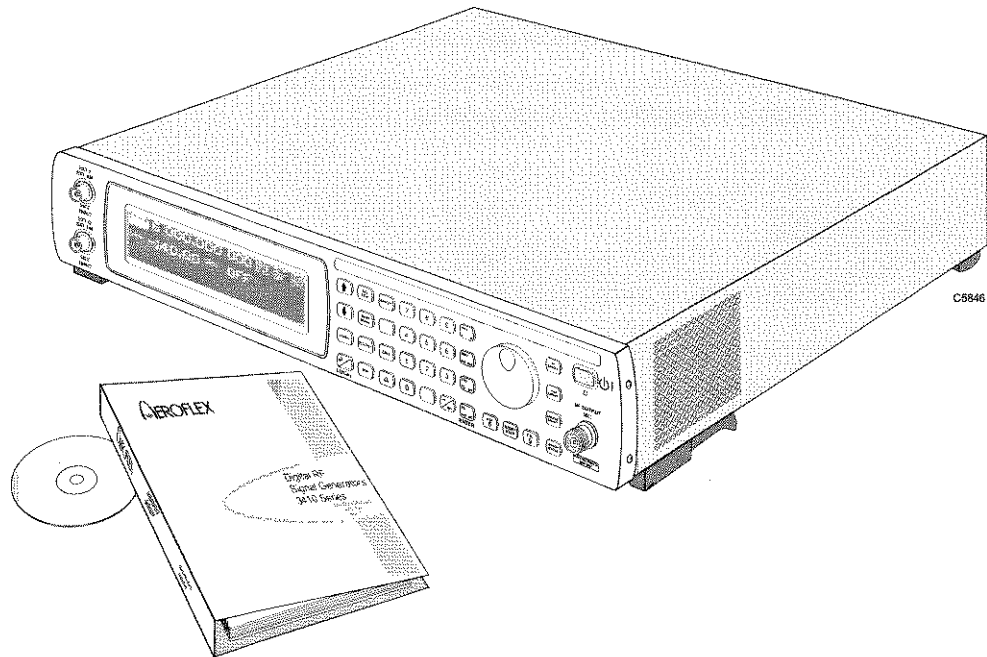

Introduction

Welcome to the operating manual for the 3410 Series digital RF signal generator family. These instruments use a touch-sensitive display and a keypad to provide efficient and intuitive control and entry of information. Select a main function by touching its details on the screen; then a single key-press takes you to the adjustable parameters contained within that function. Another key-press takes you back. It's as easy as that!

The 3410 Series portable digital RF signal generators cover a range of carrier frequencies up to 6 GHz. High quality analog and vector modulation capabilities make these generators ideal for research, development and manufacturing.

The 3410 Series digital RF signal generators offer the following features:

Wide frequency coverage

3412	250 kHz to 2 GHz
3413	250 kHz to 3 GHz
3414	250 kHz to 4 GHz
3416	250 kHz to 6 GHz

Simple operation

Back-lit liquid crystal display incorporating a touch panel overlay.

Data input via keypad or rotary control.

RF output

A choice of electronic or mechanical (relay) attenuator:

Electronic attenuator provides +16 dBm peak output power with high level accuracy and fast switching

Mechanical attenuator provides +19 dB peak output power with reduced switching speed.

Fast-responding reverse power protection.

Excellent RF level accuracy in the output control system and attenuator minimizes uncertainty and maximizes repeatability in manufacturing.

Spectral purity

Excellent spectral purity: typically 1.5 Hz residual FM at 1 GHz.

Analog modulation

Single key press turns modulation on and off for fast signal-to-noise testing.

FM/AM bandwidth to 20 MHz/30 MHz respectively.

Minimal carrier frequency errors with FM DC coupling.

Excellent phase noise performance.

Internal modulation oscillator generates two tones: sine, square, triangular and sawtooth waveforms.

Vector modulation

High-performance IQ modulator provides excellent ACP, low vector error and low noise.

IQ modulator supports wideband and narrow-band modulation standards.

Excellent adjacent channel power performance.

Digital modulation

Optional dual-channel arbitrary waveform generator (ARB).

Choose from a library of IQ modulator drive waveforms.

Change waveforms in a few milliseconds.

Waveforms simulate the characteristics of any digitally-modulated communication system.

Low ACP and spectral noise density through high sampling rate.

ARB plays customized or your own waveforms.

Optional real-time base band (RTBB) generation.

Choose from FSK, PSK, QAM modulation.

Baseband frequency hopping over 20 MHz bandwidth.

Digital IQ interface.

Pulse modulation

Optional pulse modulator provides fast rise-time RF signals.

Differential IQ outputs

Optional differential IQ outputs have voltage bias and offset facilities to simplify component and module testing.

Remote control

Fast GPIB interface and agile RF hardware provide rapid response in ATE applications.

VXI plug-and-play drivers available to simplify code generation.

LAN protocols VXI-11, TELNET and FTP supported.

Size

2U rack height occupies minimal space in manufacturing rack or on test bench.

Light weight for portability.

Rack mounting kit available.

Performance data

Specifications guaranteed under the following conditions:

20 minutes warm-up time at ambient temperature
 specified environmental conditions met
 calibration cycles adhered to
 total calibration performed
 specifications apply for the default phase noise 'optimized > 10 kHz' unless otherwise stated.

CARRIER FREQUENCY

Range:	250 kHz to 2 GHz (3412) 250 kHz to 3 GHz (3413) 250 kHz to 4 GHz (3414) 250 kHz to 6 GHz (3416)
Resolution:	1 Hz
Accuracy:	Equal to the frequency standard accuracy
Phase incrementing:	The carrier phase can be advanced or retarded in steps of 0.036° using the rotary control.

FREQUENCY SETTING TIME (NON LIST MODE)

after receipt of GPIB interface
 delimiter (terminator), 23°C ±5°C

Phase noise mode optimized > 10 kHz:	< 5.5 ms, typically 4 ms	≤ 375 MHz, to be within ≤ 200 Hz > 375 MHz, to be within ≤ 0.1 ppm
Phase noise mode optimized < 10 kHz:	< 3 ms, typically 2.5 ms < 2.5 ms, typically 2 ms	≤ 375 MHz, to be within ≤ 200 Hz > 375 MHz, to be within ≤ 0.1 ppm

FREQUENCY SETTING TIME (OPTION 10 LIST MODE)

after external trigger in list mode,
 23°C ±5°C

Phase noise mode optimized > 10 kHz:	< 4 ms, typically 3 ms	≤ 375 MHz, to be within < 200 Hz > 375 MHz, to be within < 0.1 ppm
Phase noise mode optimized < 10 kHz:	< 600 μs, typically 500 μs < 500 μs, typically 450 μs	≤ 375 MHz, to be within < 200 Hz > 375 MHz, to be within < 0.1 ppm

RF OUTPUT

The RF output is controlled by an ALC system in normal operation. When IQ modulation is enabled, alternative control modes are available to optimize the performance of the signal generator.

Range:

Electronic attenuator

≤ 10 MHz	-140 to +13 dBm
≤ 2 GHz	-140 to +16 dBm
≤ 3 GHz	-140 to +16 dBm
≤ 3.75 GHz	-140 to +13 dBm
≤ 4 GHz	-140 to +10 dBm
≤ 6 GHz	-140 to +8 dBm

Mechanical attenuator

≤ 10 MHz	-140 to +16 dBm
≤ 2 GHz	-140 to +19 dBm
≤ 3 GHz	-140 to +16 dBm

No attenuator

≤ 10 MHz	0 to +21 dBm
≤ 3 GHz	0 to +22 dBm
≤ 3.75 GHz	0 to +20 dBm
≤ 4 GHz	0 to +17 dBm
≤ 6 GHz	0 to +18 dBm

When AM is selected the maximum RF output level reduces linearly by up to 6 dB, depending on the requested AM depth.

When IQ modulation is selected, maximum output is reduced by 6 dB below 100 MHz.

Resolution:

0.01 dB

RF level units

Units can be set to μV , mV, V EMF or PD; dB relative to 1 μV , 1 mV, 1 V EMF or PD; or dBm. Conversion between dB and linear units may be achieved by pressing the appropriate units key (dB or V, mV, μV).

RF output accuracy
at 23°C ± 5°C:

Electronic attenuator			
RF mode		-127 to -30 dBm	> -30 dBm
Auto	≤ 2 GHz	± 0.75 dB	± 0.50 dB
	≤ 3 GHz	± 1.00 dB	± 0.75 dB
		-110 to -30 dBm	> -30 dBm
	≤ 6 GHz	± 1.25 dB	± 1.00 dB

Mechanical attenuator			
RF mode		-127 to -28 dBm	> -28 dBm
Auto	≤ 2 GHz	± 0.75 dB	± 0.50 dB
	≤ 3 GHz	± 1.00 dB	± 0.75 dB

No attenuator			
RF mode		> 0 dBm	
Auto	≤ 2 GHz	± 0.50 dB	
	≤ 3 GHz	± 0.75 dB	
	≤ 6 GHz	± 1.00 dB	

Level accuracy with IQ modulation:

For constant envelope modulation systems: typical standard level error ± 0.15 dB
For non-constant envelope modulation systems: typical standard level error ± 0.25 dB

Temperature stability:

± 0.01 dB/°C, ≤ 3 GHz
± 0.02 dB/°C, ≤ 4 GHz, ± 0.02 dB/°C typical, ≤ 6 GHz

RF flatness:

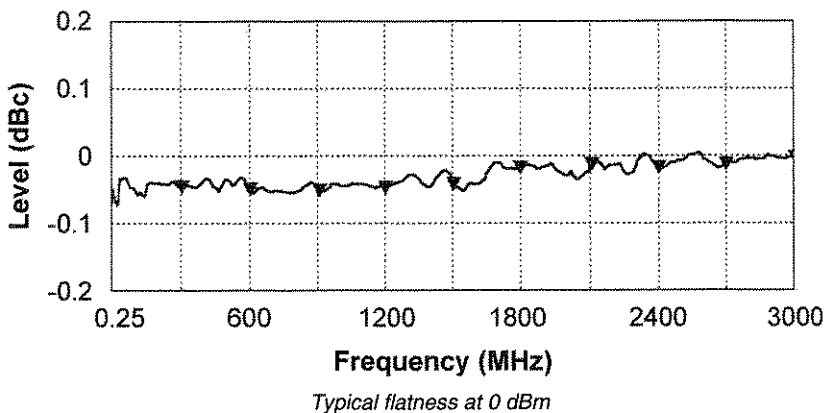

LEVEL SETTING TIME

Level setting time (non list mode):

Electronic attenuator (Option 003) is assumed in all cases. ALC loop bandwidth 'Moderate' or 'Broad', to be within ≤ 0.3 dB.

After receipt of GPIB interface delimiter (terminator), 23°C ± 5°C
< 4.5 ms, typically 2.5 ms

Level setting time (Option 10 list mode):

After external trigger in list mode, 23°C ± 5°C
< 3 ms, typically 1.5 ms

Output VSWR:

Electronic attenuator For output levels < 0 dBm	Frequency	Output VSWR
	≤ 2 GHz	1.25:1
	≤ 3 GHz	1.40:1
	≤ 4 GHz	1.50:1
	≤ 6 GHz	1.60:1
For output levels > 0 dBm, VSWR is < 1.5:1, ≤ 4 GHz, < 1.8:1, ≤ 6 GHz		
Mechanical attenuator For output levels < 0 dBm	Frequency	Output VSWR
	≤ 3 GHz	1.33:1
	For output levels > 0 dBm, VSWR is < 1.5:1, ≤ 3 GHz	
No attenuator	Frequency	Output VSWR
	≤ 4 GHz	< 1.5:1
	≤ 6 GHz	< 1.8:1
	Attenuator repeatability Mechanical attenuator	
		typically 0.1 dB

RF output connector:

Front panel 50 Ω, type N female connector to MIL-PRF-39012 Class 2

Output protection:

Protects the instrument from externally applied RF power (from a 50 Ω source) of 50 W up to 3 GHz or 25 W up to 4 GHz.

The RPP trip can be reset from the front panel or via the remote interface. For safety, protection is also provided when the instrument is switched off.

3416 damage level 0.5 W (+27 dBm) from a max 5:1 VSWR, all frequencies.

RF optimization modes:

Mode	Attenuator option	Maximum RF output power (PEP)						
		< 10 MHz	10 to 1000 MHz	1000 to 2000 MHz	2000 to 3000 MHz	3000 to 3750 MHz	3750 to 4000 MHz	4000 to 6000 MHz
Power	No attenuator	+21 dBm	+22 dBm	+22 dBm	+22 dBm	+20 dBm	+17 dBm	+18 dBm
	Relay attenuator	+16 dBm	+19 dBm	+19 dBm	+16 dBm	—	—	—
	Electronic attenuator	+13 dBm	+16 dBm	+16 dBm	+16 dBm	+13 dBm	+10 dBm	+8 dBm
Noise	No attenuator	+15 dBm	+16 dBm	+16 dBm	+16 dBm	+14 dBm	+11 dBm	+12 dBm
	Relay attenuator	+10 dBm	+13 dBm	+13 dBm	+10 dBm	—	—	—
	Electronic attenuator	+7 dBm	+10 dBm	+10 dBm	+10 dBm	+7 dBm	+4 dBm	2
ACP	No attenuator	+6 dBm	+6 dBm	+6 dBm	+6 dBm	+6 dBm	+6 dBm	+6 dBm
	Relay attenuator	+4 dBm	+4 dBm	+4 dBm	+4 dBm	—	—	—
	Electronic attenuator	0 dBm	0 dBm	0 dBm	0 dBm	0 dBm	-2 dBm	-4 dBm

SPECTRAL PURITY

All parameters stated at RF level $\leq +7$ dBm in Noise and ACP RF modes.

Harmonics:

< -30 dBc, typically < -40 dBc

Sub- and non-harmonics:

For offsets > 10 kHz:

< -70 dBc for carrier frequencies ≤ 3 GHz

< -60 dBc for carrier frequencies ≤ 6 GHz

Residual FM (FM on CW):

< 2.5 Hz RMS (typically 1.5 Hz) at 1 GHz in a 300 Hz to 3.4 kHz unweighted bandwidth

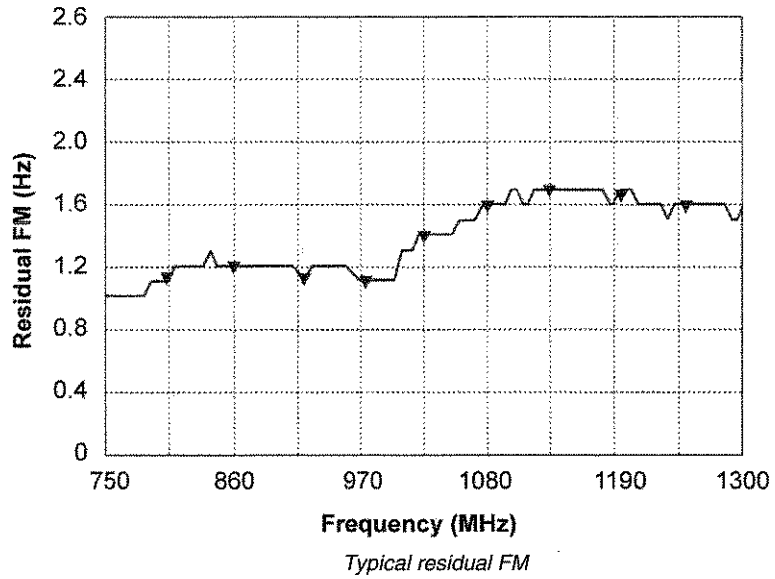

SSB phase noise:

For 20 kHz offset, Noise Optimized mode:

CW/IQ	
≤ 375 MHz	< -115 dBc/Hz
500 MHz	< -124 dBc/Hz
1 GHz	< -118 dBc/Hz
2 GHz	< -112 dBc/Hz
3 GHz	< -108 dBc/Hz
4 GHz	< -106 dBc/Hz
6 GHz	< -102 dBc/Hz

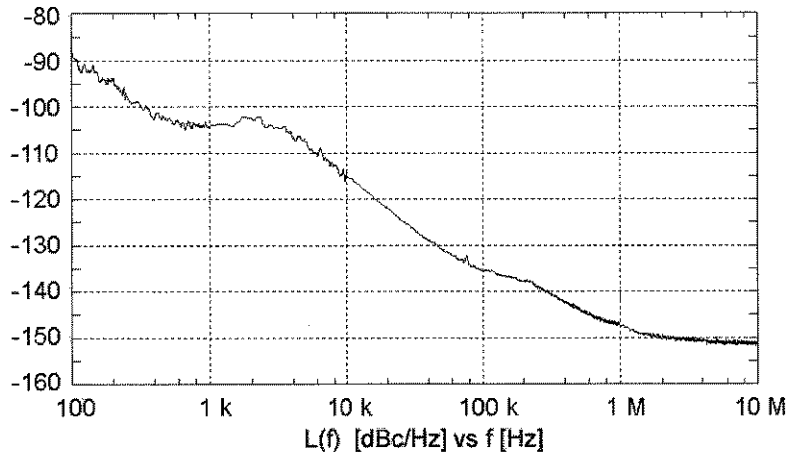

Typical SSB phase noise at 1 GHz,
phase noise optimized > 10 kHz offset

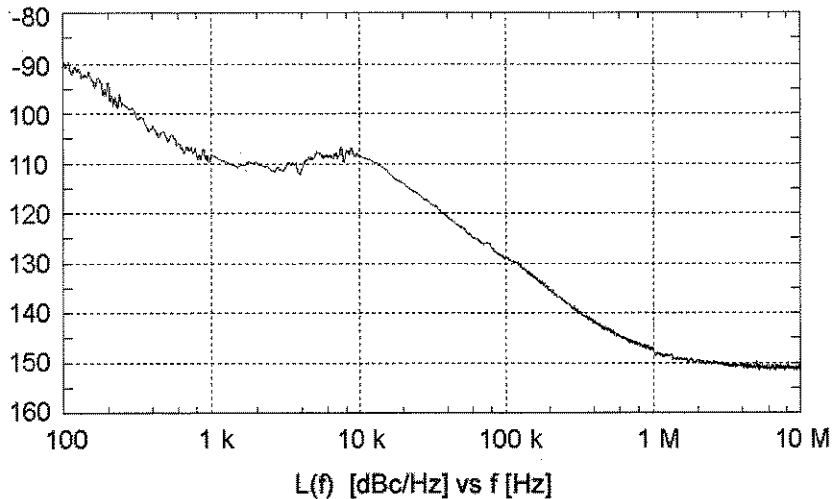

Typical SSB phase noise at 1 GHz,
phase noise optimized < 10 kHz offset

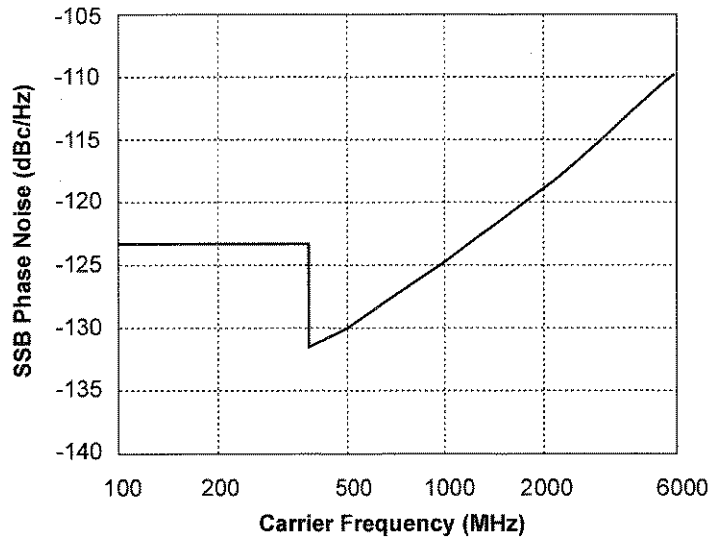

Typical SSB phase noise performance at 20 kHz offset,
phase noise optimized > 10 kHz offset

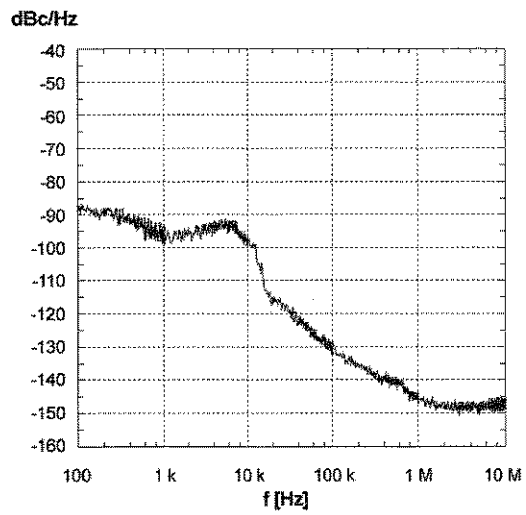

Typical phase noise at 2.1 GHz

SSB AM noise:

For 20 kHz offset (typical values), measured at levels > 0 dBm:

CW/IQ	
≤ 3 GHz	-130 dBc/Hz
≤ 6 GHz	-125 dBc/Hz

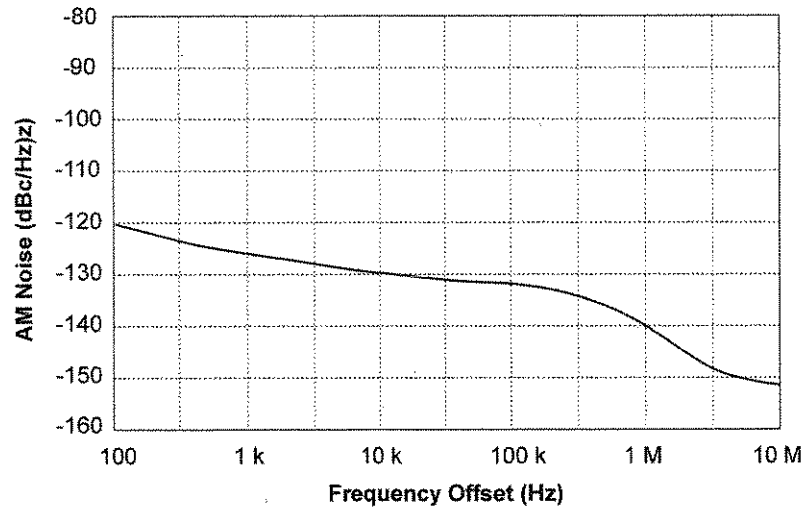

Typical AM noise at 1 GHz

RF leakage:

< 0.5 μ V PD at the carrier frequency into a single-turn 25 mm diameter loop, 25 mm or more from the case of the signal generator, for carrier frequencies < 3 GHz

Wideband noise:

Applicable for all carrier levels at offsets > 5 MHz and < 50 MHz excluding thermal noise (23°C \pm 5°C):

RF mode	≤ 375 MHz	≤ 3 GHz	≤ 6 GHz
Power	< -138 dBc/Hz	< -142 dBc/Hz (typ -148 dBc/Hz)	< -136 dBc/Hz
Noise	< -138 dBc/Hz	< -142 dBc/Hz (typ -148 dBc/Hz)	< -136 dBc/Hz
ACP	< -135 dBc/Hz	< -140 dBc/Hz	< -134 dBc/Hz

MODULATION

FM, AM and Φ M can be applied to the carrier using internal or external modulation sources. The internal modulation source is capable of generating two simultaneous signals into any one of the modulation channels. The internal and external modulation sources can be enabled simultaneously to produce combined amplitude and frequency (or phase) modulation.

Internal and external IQ modulation can be applied. In this mode, FM, AM and Φ M are not permitted.

Optional pulse modulation can be used in combination with FM, AM, Φ M and IQ from an external pulse source.

Frequency modulation

Peak deviation:	Frequency	Maximum peak deviation
	250 kHz to 375 MHz	7.5 MHz
	375 MHz to 750 MHz	3.75 MHz
	750 MHz to 1.5 GHz	7.5 MHz
	1.5 GHz to 3 GHz	15 MHz
	3 GHz to 6 GHz	30 MHz
Displayed resolution:	4 digits or 1 Hz	
FM accuracy (at 1 kHz rate):	$\pm 3\%$ of set deviation, excluding residual FM	
FM bandwidth:	0.5 dB	DC to 200 kHz (DC coupled, 100 k Ω) 10 Hz to 200 kHz (AC coupled, 100 k Ω)
	3 dB	Typically 20 MHz (DC or AC coupled, 50 Ω)

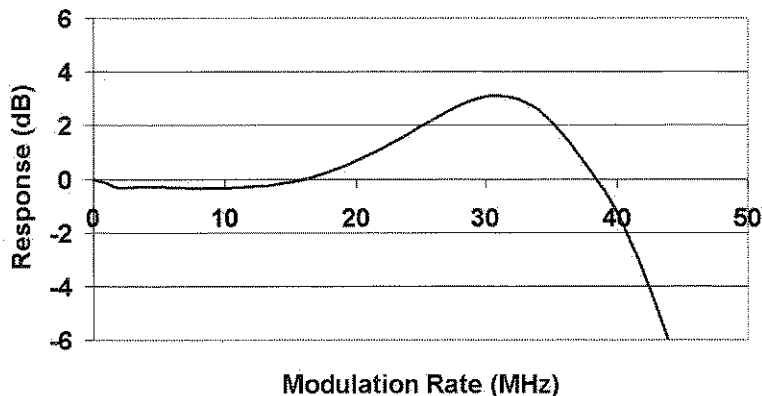

Typical FM bandwidth

Carrier frequency offset:	For DC coupled FM $\pm (1 \text{ Hz} + 0.1\% \text{ of the set deviation})$ after performing a DCFM null operation
Total harmonic distortion:	At 1 kHz rate: < 0.15% for deviations up to 2% of maximum allowed deviation < 0.6% for deviations up to 20% of maximum allowed deviation < 1.5% at maximum deviation

Phase modulation

Phase deviation:	0 to 10 radians Displayed resolution is 4 digits or 0.01 radians
Accuracy (at 1 kHz rate):	$\pm 4\%$ of set deviation excluding residual phase modulation
Bandwidth:	0.5 dB 100 Hz to 10 kHz (AC coupled, 100 k Ω)
Total harmonic distortion:	At 1 kHz rate: < 0.5% at 10 radians deviation Typically < 0.1% at 1 radian deviation

Amplitude modulation

Specifications apply for carrier frequencies from 2 MHz up to 2 GHz, usable to 4 GHz, and in ACP and Noise modes.
 Maximum specified output power is reduced by 2 dB, ≤ 10 MHz for 'No attenuator' Option 001 with AM selected.

Modulation depth:	0 to 99.9%
	Displayed resolution is 3 digits or 0.1%
Accuracy at 1 kHz rate:	$\pm 4\%$ of set depth $\pm 1\%$ excluding residual AM
AM bandwidth (1 dB):	1 dB DC to 200 kHz (DC coupled, 100 k Ω) 10 Hz to 200 kHz (AC coupled, 100 k Ω)
	3 dB DC to typically 30 MHz (DC or AC coupled, 50 Ω)

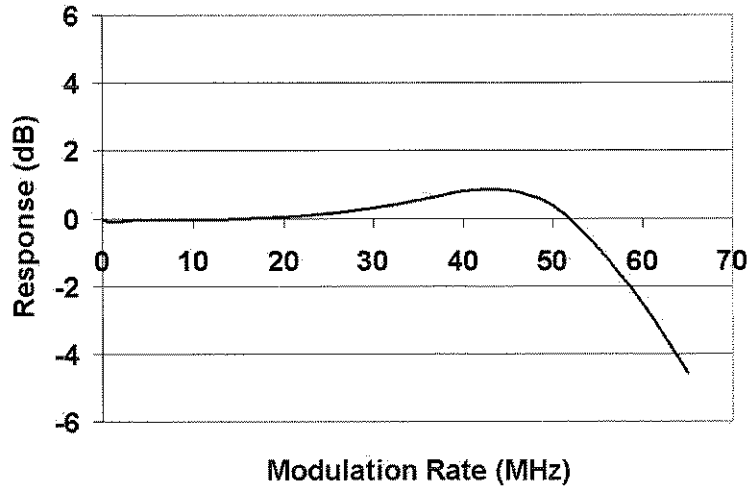

Typical AM bandwidth

Total harmonic distortion:	At 1 kHz modulation rate: < 1% for depths up to $\leq 30\%$ < 2% for depths up to $\leq 80\%$
FM on AM:	Typically < 20 Hz for 30% AM depth at a modulation rate of 1 kHz and carrier frequency of 500 MHz
Φ M on AM:	Typically < 0.02 radian for 30% AM depth at a modulation rate of 1 kHz and carrier frequency of 500 MHz

IQ modulation

IQ inputs:

Performance applicable in ACP and Noise modes only

BNC connector inputs, selectable 50 Ω/100 kΩ input impedance

Full-scale input $(I^2+Q^2)^{0.5}$ occurs for 0.5 V RMS (the level requested is obtained by applying 0.5 V DC to either the I or Q input)

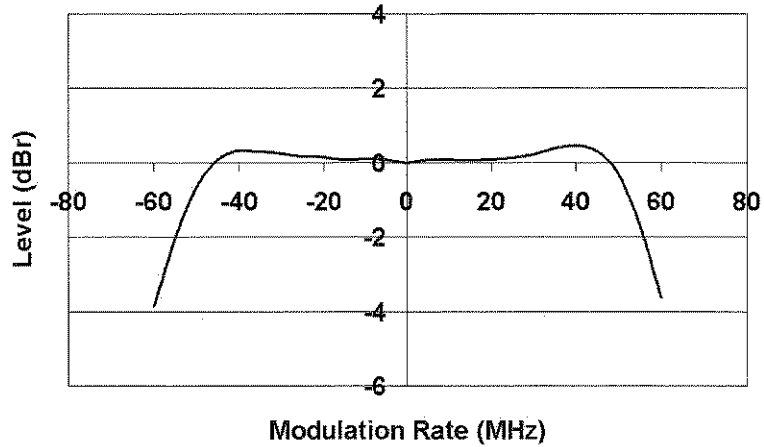

Typical IQ bandwidth

Modulation bandwidth relative to DC:

At 23°C ± 5°C:

± 0.5 dB for frequencies DC to 5 MHz

1 dB for frequencies DC to 10 MHz

3 dB:

RF mode	≤ 2.8 GHz	≤ 6 GHz
Noise	> 42 MHz, typ 50 MHz	> 35 MHz, typ 45 MHz
ACP	> 48 MHz, typ 55 MHz	> 40 MHz, typ 50 MHz

DC vector accuracy:

Relative to full scale (0.5 V RMS):

Static error vector magnitude (EVM): < 1% RMS at full scale

Magnitude error: < 0.5% RMS at full scale

Phase error: < 0.5° RMS at full scale

Residual carrier magnitude:

For 0 V input voltage, relative to full scale:

RF mode	
Noise	< -45 dBc, typically < -55 dBc
ACP	< -40 dBc, typically < -50 dBc

Valid for 12 hours after executing an IQ self-calibration and within ± 5°C of the calibration temperature. The instrument displays a warning if the time or temperature limits are exceeded.

Static EVM and phase error measured with residual carrier magnitude removed.

IQ image suppression:

At 10 kHz modulation frequency:
Typically < -50 dBc at 10 kHz

Linearity:

Adjacent Channel Power (ACP), in ACP mode for continuous and discontinuous signals at RF output levels ≤ 0 dBm, over the temperature range $23^{\circ}\text{C} \pm 5^{\circ}\text{C}$:

	TETRA	GSM 900 / 1800 / 1900 GSM EDGE (Enhanced Data rate for GSM Evolution)	802.11a Wireless Lan (Spectral Mask) at RF o/p level ≤ -4 dBm	IS-95 (CDMAone)
Frequency range(s)	130 MHz–1 GHz	850 MHz–1 GHz 1700–1900 MHz	5.15–5.825 GHz	824–894 MHz 1850–2000 MHz
ACLR (continuous and discontinuous)	< -70 dBc @ 25 kHz offset typ < -80 dBc @ 50 kHz offset typ < -80 dBc @ 75 kHz offset	< -35 dBc @ 200 kHz offset < -70 dBc @ 400 kHz offset < -80 dBc @ 600 kHz offset	< -25 dBc @ 11 MHz offset < -45 dBc @ 20 MHz offset typ < -60 dBc @ 30 MHz offset	< -65 dBc @ 885 kHz offset < -75 dBc @ 1.25 MHz offset < -80 dBc @ 1.98 MHz offset
	3GPP/WCDMA	NADC (IS-54, IS-136)	JDC/PDC	PHP/PHS
Frequency range(s)	1855–2200 MHz	824–894 MHz 1850–2000 MHz	810–826 MHz 940–956 MHz 1429–1513 MHz	1895–1918 MHz
ACLR (continuous and discontinuous)	< -70 dBc @ 5 MHz offset typ < -72 dBc @ 5 MHz offset	< -40 dBc @ 30 kHz offset typ < -78 dBc @ 60 kHz offset typ < -80 dBc @ 90 kHz offset	< -65 dBc @ 50 kHz offset typ < -80 dBc @ 100 kHz offset	< -75 dBc @ 600 kHz offset < -80 dBc @ 900 kHz offset

RF burst control

A digital control bit is used to generate an analog ramp (up or down) of the RF output. The burst gate control signal can either be generated internally as part of the optional internal baseband source, or provided externally by the user on the rear-panel connector. When internally generated, the burst gate control signal appears on the rear-panel auxiliary connector, which then serves as an output.

On/off ratio:

For the temperature range $23^{\circ}\text{C} \pm 5^{\circ}\text{C}$:

- > 90 dB for carriers ≤ 3 GHz
- > 80 dB for carriers ≤ 4 GHz
- > 65 dB for carriers ≤ 6 GHz

Ramp profile:

Rise and fall time after the L to H and H to L transitions of the burst control bit respectively can be defined by the user, from 10 μs to 999 μs in 0.1 μs steps.

RF ramp can be adjusted in time by ± 50 μs in increments of 0.1 μs with respect to the trigger event.

Burst gate control input:

TTL level (HCT), 50 Ω impedance BNC input on the rear panel.

RF burst attenuation control

A digital attenuation control bit (in conjunction with the ramp control bit) is used to decrease the RF level from the set level to an alternative level during burst modulation. The burst attenuation trigger signal can be provided internally as part of the optional dual arbitrary waveform generator (ARB), or externally on a rear-panel connector. When internally generated, the burst attenuation trigger control signal appears on the rear-panel auxiliary connector, which then serves as an output.

RF burst attenuation requires electronic attenuator Option 003.

Attenuation range available:

0 to 70 dB

Burst attenuation control input:

TTL level (HCT), 50 Ω impedance signal on the rear panel AUX connector.

Internal modulation oscillator

The internal modulation source is capable of generating up to two simultaneous signals into any one of the modulation systems.

Frequency range: 0.1 Hz to 50 kHz (16 MHz with Option 005)

Resolution: 0.1 Hz or 5 digits

Accuracy: As frequency standard

Distortion: < 0.1% for a sine wave at 1 kHz

Waveforms: In addition to a sine wave, the following waveforms can be generated:
 Triangle 0.1 Hz to 10 kHz (2 MHz with Option 005)
 Ramp 0.1 Hz to 10 kHz (2 MHz with Option 005)
 Square 0.1 Hz to 5 kHz (1 MHz with Option 005)

Note: modulation frequency can be set to 50 kHz irrespective of waveform type

Level: Modulation source signals are available on the rear-panel I/AM OUT and Q/FM OUT at a level of 1 V peak EMF from a 50 Ω source impedance.

External modulation source

External inputs are available with a selectable input impedance of 50 Ω or 100 kΩ (default setting), AC or DC coupled.

Input level: Apply 1 V RMS (default) or 1 V peak for the set modulation.
 A HI/LO indicator appears on-screen when the applied signal is greater than ± 6% from the nominal.
 External AM is input to the EXT I/EXT AM front-panel BNC connector.
 External FM is input to the EXT Q/EXT FM front-panel BNC connector.

SWEEP FACILITY

Provides a digital sweep of RF frequency or RF level in discrete steps.

The sweep can be set to be continuous, single or externally triggered from the rear panel. TTL BNC female rear panel.

Control parameters: Start and stop values of carrier frequency, step size, number and step time

Frequency sweep: Linear step size: 1 Hz minimum
 Logarithmic: 0.01% to 50%, 0.01% step

Level sweep: 0.01 dB minimum step

Step time: 2.5 ms to 10 s per step with 0.1 ms resolution (20 ms for mechanical attenuator, Option 002).

Modulation oscillator: 0.1 Hz minimum frequency step

LIST MODE

Up to 500 frequencies and levels can be entered in the list. Start address, stop address and dwell time can be controlled. Dwell time can be set from 500 ms to 10 s. Requires Option 003 electronic attenuator.

NON-VOLATILE MEMORY STORES

Full instrument configurations can be saved to 100 memory stores (0–99)

FREQUENCY STANDARD

10 MHz OCXO fitted as standard. Standby power is provided while the instrument is off but connected to the supply.

Aging rate: < $\pm 0.8 \times 10^{-7}$ per year after 30 days' continuous use

Temperature coefficient: < $\pm 5 \times 10^{-8}$ over the temperature range 0 to 50°C

Output frequency: Within 2×10^{-7} of final frequency after 10 minutes from connecting supply power and switching on at a temperature of 20°C.

Output: Rear-panel BNC connector provides an output of 2 V pk-pk from 50 Ω.

External standard input: Rear-panel BNC connector accepts an input of 1 MHz or 10 MHz at a level of 300 mV to 1.8 V RMS into 1 kΩ

INTERNAL DUAL-CHANNEL ARB SOURCE (OPTION 005)

A high performance dual Arbitrary Waveform Generator (ARB) provides IQ signals for the IQ modulator.

The ARB enables files to be downloaded with sample rates from 17 kHz to 66 MHz. The ARB uses an interpolation system to increase the digital to analog converter sample rate and avoid the use of reconstruction filters.

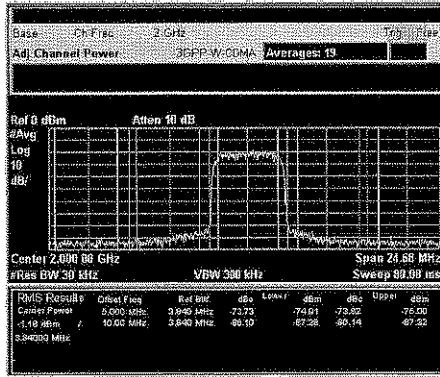

Typical 3GPP test model 1 (64 channels)

- Flash memory size: 23 592 960 sample pairs
- Maximum number of files: 180
- Sample format: 32 bits of data — 14 bits I, 14 bits Q, 3 associated marker bits
- Sample rate tuning: ± 20 ppm, 0.1 ppm step resolution
- D-A converter resolution: 14 bits
- D-A sample rate: 44 to 66 Msamples/s
- Interpolation factor: Automatically selected
- Reconstruction filter stop band attenuation: > 70 dB
- ARB spectral purity:
 - Spurious-free dynamic range: > 70 dBc, typically > 80 dBc
 - 20 kHz offset phase noise: < -120 dBc/Hz
 - Floor noise: < -140 dBc/Hz

IQCreator® Windows™ based software package is provided for the creation, formatting and downloading of ARB waveform files to the 3410 Series.

A waveform library is provided on a CD containing a selection of files for testing 2G, 2.5G and 3G systems. Files can be downloaded from www.aeroflex.com.

Marker control bits: Up to three marker bits (1–3) can be attached to each sample of IQ data. These can be used to indicate significant points in the waveform and are available as HC CMOS outputs via the rear-panel AUX IN/OUT connector. Marker bit 1 can be used as an RF burst control signal. Marker bit 2 can be used as a burst attenuation trigger signal to decrease (attenuate) the RF level from its nominal value.

Control mode: Continuous, single or triggered operation of the ARB.

An external trigger input signal is available on the AUX IN/OUT rear-panel connector.

IQ outputs (not applicable when Option 009 is fitted): The IQ signals produced by the ARB are available on the rear-panel I/AM OUT and Q/FM OUT BNC connectors. Output level is 0.5 V RMS EMF (vector sum) from a source impedance of 50 Ω.

FAST PULSE MODULATOR (OPTION 006)

This option requires electronic attenuator (Option 003) to be fitted.

- On/off ratio: > 80 dB for carrier levels ≥ -60 dBm
- Rise/fall time: < 20 ns typical (10 to 90%)
- Pulse delay: Typically < 50 ns

RF level accuracy	RF mode = 'auto', as standard ± 0.2 dB The above specification is met for all power levels above 150 MHz.
AM depth and distortion	AM operation is unspecified below 10 MHz. AM depth and distortion specification is degraded for operation above 0 dBm at carrier frequencies < 150 MHz.
Video breakthrough:	RF mode
	Power < ± 50 mV for RF levels > +10 dBm < ± 25 mV for RF levels in the range -10 dBm to +10 dBm < ± 10 mV for RF levels \leq -10 dBm
	Noise < ± 50 mV for RF levels > +4 dBm < ± 25 mV for RF levels in the range -16 dBm to +4 dBm < ± 10 mV for RF levels \leq -16 dBm
	ACP < ± 50 mV for RF levels > -6 dBm < ± 25 mV for RF levels in the range -26 dBm to -6 dBm < ± 10 mV for RF levels \leq -26 dBm
Modulation source:	PULSE IN BNC (female) connector rear panel
Input impedance:	50 Ω
Input level:	TTL level (HCT)
Control voltage:	HCT logic 0 (0 V to 0.8 V) turns the carrier OFF HCT logic 1 (2 V to 5 V) turns the carrier ON
Maximum safe input level:	± 10 V

**REAR-PANEL OUTPUTS
(OPTION 007)**

With this option fitted, RF OUTPUT, EXT I/EXT AM input and EXT Q/EXT FM input connectors are transferred to the rear panel. When Option 009 is fitted, only the RF OUTPUT connector is transferred to the rear panel. The standard signal generator specification remains unaltered.

**REAL-TIME BASEBAND
(OPTION 008)**

Allows the creation of digitally-modulated signals using generic modulation formats. An internal data source provides PRBS or fixed patterns. External real-time data in the form of symbol data, or digital IQ data, may be applied via an LVDS interface.

Generic modulation formats

PSK:	BPSK, QPSK, 8PSK, 16PSK, 8PSK EDGE (8PSK with $3\pi/8$ rotation), $\pi/2$ DBPSK, $\pi/4$ DQPSK, $\pi/8$ D8PSK, DBPSK, DQPSK, D8PSK, OQPSK (time offset)
MSK:	GMSK
FSK/GFSK:	2- and 4-level symmetric
QAM:	16, 32, 64, 128, 256 levels

For data bit to symbol mapping information refer to Technical Note 'IFR 3410 Option 8 RTBB Ancillary Information'.

Symbol rate

Range:	5 kHz to 2 MHz
Resolution:	1 Hz

Baseband channel filters

Filter types:	Nyquist: a = 0.1 to 0.8, resolution 0.01
	Root Nyquist: a = 0.1 to 0.8, resolution 0.01
	Gaussian: Bt 0.1 to 1.0, resolution 0.1
	EDGE: 'Linearized Gaussian' as defined in GSM 05.04

Data source

Formats: Internal data: PRBS — PN9, PN11, PN15, PN16, PN20, PN21, PN23
 Fixed pattern consisting of: 0, 0, 0, 0, 0, 0...
 0, 1, 0, 1, 0, 1...
 1, 0, 1, 0, 1, 0...
 1, 1, 1, 1, 1, 1...
 User-defined symbol file stored in non-volatile memory (max. size 256 kB)

External serial data: A single bit-stream representing symbol information can be applied. The bit-to-symbol conversion is determined from the selected modulation type.

External parallel data: Symbol information consisting of 1 to 8 data bits can be applied. External parallel and serial data is input via the LVDS connector on the rear panel.

Data encoding

None
 Differential
 GSM differential
 Inverted

Timing/synchronization

All clock and synchronization signals are provided internally by Option 8 RTBB and made available to the user on the rear-panel LVDS connector. An external clock may be phase-aligned to the internal clock via a 'sync' operation.

External serial data clock: Eight times the symbol rate, for all modulation types

External parallel data clock: Nominal symbol rate

Frequency hopping

Frequency hop list: Up to 32 frequency values. The frequency values entered represent offset values from the current RF frequency.

Frequency offset values: Offset values range ± 10 MHz

Modes

Linear: On receipt of a hop trigger, the next frequency in the list is indexed.

Random: On receipt of a hop trigger, an internal PRBS generator indexes through the frequency list. PN length, polynomial and initial seed value. PN values selectable from 9, 11, 15, 16, 20, 21, 23.

External: On receipt of a hop trigger, the 5-bit hop address lines applied to the LVDS connector are used to index the frequency list.

Hop rate: Max. hop rate (hops/s) is half the symbol rate. Hopping is synchronized to symbol transition.

Digital IQ data

Digital IQ data is available via the LVDS connector on the rear panel.

External IQ data in

External 16-bit IQ data can be applied to the LVDS interface. The data can then be filtered or not, depending on the application, by the baseband board and fed to the DACs. All clock and sync signals are located on the LVDS connector. These can be used to synchronize to an externally applied clock.

Internal IQ data out

16-bit IQ data is available on the LVDS interface when the modulation is generated internally. Outputs can be disabled.

Tones A tone (CW) only mode is available. Up to two tones may be selected. Each tone may be independently enabled and disabled.

Frequency range: Carrier frequency ± 10 MHz

Relative level: 60 dB

DIFFERENTIAL IQ OUTPUT (OPTION 009)

When differential IQ outputs are enabled, the signal generator RF is CW only.

Output impedance: Can be used with single-ended 50 Ω loads or differential 100 Ω loads. Delivered bias voltages are halved with single-ended loads.

IQ bias voltages: Independent I and Q channel bias voltages settable within the range ± 3 V.

Bias voltage: Resolution: 1.0 mV nominal
Accuracy: $\pm 2\% \pm 4$ mV max, $\pm 1\% \pm 2$ mV typical
Offset: see IQ bias voltages above

Differential offset voltage: Range: ± 300 mV
Resolution: 100 μ V nominal
Accuracy: $\pm 2\% \pm 3.3$ mV max, $\pm 1\% \pm 0.7$ mV typical

Level mode: Variable IQ signal level over 45 dB range

Differential signal balance: Typically 0.15 dB at 10 MHz

IQ channel balance: ± 0.2 dB at 1 MHz

IQ level imbalance adjust: ± 4 dB nominal, continuously variable

IQ signal amplitude: 22.4 mV to 4 V pk-pk per channel

IQ signal amplitude accuracy: $< 2\%$ at 20 kHz, typically 1.5%, excludes termination errors

Baseband purity (2 V p-p set voltage at 1 MHz): 2nd harmonic: -70 dBc
3rd harmonic: -65 dBc
IMD: -70 dBc (100 kHz tone spacing at 1 MHz)

REMOTE CONTROL

Ethernet: All signal generator parameters except the supply switch are remotely programmable. The following LAN protocols are supported:
VXI-11
Telephone Network (TELNET)
File Transfer Protocol (FTP) (software upgrades only).

RS-232: All functions except the supply switch are remotely programmable.
Can be used for upgrading the firmware without removing the instrument's covers.

GPIB: All functions except the supply switch are remotely programmable.
Capabilities: Designed in accordance with IEEE 488.2.
Interface functions: SH1, AH1, T6, L4, SR1, RL1, PP0, DC1, DT1, C0, E2

ELECTROMAGNETIC COMPATIBILITY

Conforms to the protection requirements of Council Directive 89/336/EEC.

Conforms with the limits specified in the following standards:
IEC/EN 61326-1 : 1997 + A1 : 1998 + A2 : 2001
Emission: Class B.
Immunity: Table 1 and Performance Criterion B.

SAFETY

Conforms with the requirements of EEC Council Directive 73/23/EEC (as amended) and the product safety standard IEC/EN 61010-1 : 2001 + C1 : 2002 + C2 : 2003 for Class 1 portable equipment, for use in a Pollution Degree 2 environment. The instrument is designed to operate from an Installation Category 2 supply.

GENERAL INFORMATION

RATED RANGE OF USE

MIL-T-28800E Class 5

Temperature: 0 to 50°C (32 to 122°F),
Humidity: 45%, 0 to 50°C (32 to 122°F)
95%, 30 to 40°C (86 to 104°F)
Altitude: 700 mbar, 3050 m (10 000 ft)

CONDITIONS OF STORAGE AND TRANSPORT

MIL-T-28800E Class 5

Temperature: -40°C to +71°C (-40 to 160°F)
Altitude: 570 mbar, 4570 m (15 000 ft)

POWER REQUIREMENTS

100–240 V~ (limit 90–264 V~)
50–60 Hz~ (limit 45–66 Hz~)
185 VA maximum

CALIBRATION INTERVAL

Recommended at 2 years

WARRANTY

2 years, with options for 3, 4 or 5 years

DIMENSIONS AND WEIGHT

Height: 107 mm (4.2 inch) overall
89 mm (3.5 inch) rack mount (occupies 2U of rack height excluding feet and front handles)

Width: 468 mm (19 inch) overall
425 mm (16.7 inch) rack mount

Depth: 545 mm (21.5 inch) overall and rack mount

Weight: 3412, 3413, 3414: 10.5 kg (23.1 lb)
3416: 11.5 kg (25.3 lb)

Options

Option 001: No attenuator

CAUTION

The instrument has no reverse power protection when this option is fitted.

Option 002: Mechanical attenuator

Not available on 3414 or 3416.

Option 003: Electronic attenuator

Option 005: Dual-channel arbitrary waveform generator (ARB)

Not available with Option 008.

Option 006: Pulse modulation

Requires Option 003. Not available with Option 009.

Option 007: Rear-panel outputs

The front-panel connectors RF OUTPUT, EXT I/EXT AM and EXT Q/EXT FM are relocated to the rear panel for rack-mounted operation. I/AM OUT and Q/FM OUT are relocated to the front panel.

For instruments fitted with Option 009, only the RF OUTPUT connector is relocated.

Option 008: Real-time baseband

Not available with Options 005 or 009.

Option 009: Differential IQ outputs

Requires Option 005. Not available with Options 006 or 008.

Option 010: List mode

Requires Option 003.

Option 020: 2G CDMA software license

Permits 2G CDMA waveforms created by **IQCreator**® to be downloaded into a 3410 Series instrument.

Option 021: 3G CDMA software license

Permits 2G and 3G CDMA waveforms created by **IQCreator**® to be downloaded into a 3410 Series instrument.

Versions and accessories

When ordering, please quote the full ordering number information.

Ordering numbers	Version
3412	250 kHz to 2 GHz Digital RF Signal Generator
3413	250 kHz to 3 GHz Digital RF Signal Generator
3414	250 kHz to 4 GHz Digital RF Signal Generator
3416	250 kHz to 6 GHz Digital RF Signal Generator
Options	
Option 001	No attenuator
Option 002	Mechanical attenuator
Option 003	Electronic attenuator
Option 005	Dual-channel arbitrary waveform generator (ARB)
Option 006	Pulse modulation
Option 007	Rear-panel outputs
Option 008	Real-time baseband
Option 009	Differential IQ outputs
Option 010	List mode
Option 020	2G CDMA software license
Option 021	3G CDMA software license
Supplied accessories	
-	AC supply lead (see 'Power cords', Chapter 2)
46882/499	Operating manual (paper version)
46882/599	IQCreator ® 'Getting started' manual (paper version)
46882/627	IQCreator ® User Guide (paper version)
46886/015	CD-ROM containing operating manual, data sheet, test results, certificate of calibration, application notes, driver software, performance verification software, IQCreator ® software and manuals, waveform files, virtual front panel.
46882/502	Safety information
Optional accessories	
46880/111	Service manual (paper version). Consists of Operating Manual (this document), Maintenance Manual part no. 46882/500, together with CDROM containing PDFs of the manuals and adjustment and diagnostic software.
43129/189	GPIB lead assembly, 1.5 m (5 ft)
46884/649	RS-232 cable, 9-way female to 25-way female, 1.5 m (5 ft)
46884/650	RS-232 cable, 9-way female to 9-way female, 1.5 m (5 ft)
46885/138	Rack mounting kit (front panel brackets)
43139/042	RF double-screened connector cable 50 Ω , 1.5 m (5 ft), BNC (m)
54311/095	RF double-screened connector cable 50 Ω , 1 m (3 ft), type N connectors
54311/092	Coaxial adapter N male to BNC female
59999/163	Precision coaxial adapter N male to SMA female
46662/745	Soft carrying case
46662/774	Hard carrying case
82542	Auxiliary port connector breakout box



Chapter 2

INSTALLATION

Contents

Initial visual inspection	2-2
Positioning arrangements	2-2
Installation requirements	2-2
Ventilation.....	2-2
Connecting to supply.....	2-4
Disconnecting device	2-4
Standby/on switch	2-4
Fuse	2-4
Goods-in checks	2-4
RS-232 connector.....	2-5
Auxiliary port connector	2-6
List mode triggering	2-6
LVDS IN/OUT connector	2-7
LVDS data used as data source (serial mode).....	2-8
LVDS data used as data source (parallel mode).....	2-8
LVDS data used as IQ input.....	2-9
LVDS data used as IQ output.....	2-9
Markers	2-10
Hop address.....	2-10
CLK_OUT sync	2-11
Routine safety testing and inspection	2-12
Cleaning	2-12
Putting into storage	2-12

WARNING

Initial visual inspection

After unpacking the instrument, inspect the shipping container and its cushioning material for signs of stress or damage. If there is damage, retain the packing material for examination by the carrier in the event that a claim is made. Examine the instrument for signs of damage; do not connect the instrument to a supply when damage is present, as internal electrical damage could result in a shock if the instrument is turned on.

Positioning arrangements

Excessive temperatures may affect the performance of the instrument. Completely remove the plastic cover, if one is supplied over the case, and avoid standing the instrument on or close to other equipment that is hot.

Stability

If you stand the instrument on end on its rear-panel protectors, make sure that you provide support to prevent it from toppling over.

CAUTION

Installation requirements

Ventilation

This instrument is forced-air-cooled by two fans mounted on the rear panel. Air must be allowed to circulate freely through the ventilator grilles located on the sides of the instrument. Before switching on the instrument, ensure that the fan outlets on the rear panel are not restricted (leave a clearance of at least 75 mm (3 in) at the rear and 25 mm (1 in) at each side). Failing to provide adequate clearances will increase internal temperatures and may adversely affect the instrument's performance.

The fan speed is regulated and varies depending on the air temperature inside the case.

Class I power cords (3-core)

General

When the equipment has to be plugged into a Class II (ungrounded) 2-terminal socket outlet, the cable should either be fitted with a 3-pin Class I plug and used in conjunction with an adapter incorporating a ground wire, or be fitted with a Class II plug with an integral ground wire. The ground wire must be securely fastened to ground. Grounding one terminal on a 2-terminal socket will not provide adequate protection.

In the event that a molded plug has to be removed from a lead, it must be disposed of immediately. A plug with bare flexible cords is hazardous if it is engaged in a live socket outlet.

Power cords with the following terminations are available from Aeroflex. Please check with your local sales office for availability. This equipment is provided with a 3-wire (grounded) cordset, which includes a molded IEC 320 connector for connection to the equipment. The cable must be fitted with an approved plug which, when plugged into an appropriate 3-terminal socket outlet, grounds the case of the equipment. Failure to ground the equipment may expose the operator to hazardous voltage levels. Depending upon the destination country, the color-coding of the wires will differ:

North American

Country	IEC 320 plug type	Part number
North American	Straight through	23422/004
North American	Right angled	23422/005

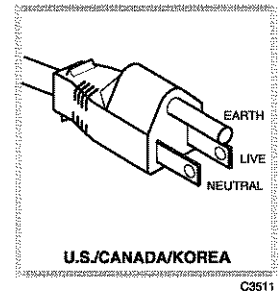

The North American lead is fitted with a NEMA 5-15P (Canadian CS22.2 No. 42) plug and carries approvals from UL and CSA for use in the USA and Canada.

Connecting to supply

The instrument is a Safety Class 1 product and therefore must be earthed. Use the supplied power cord or an appropriate replacement. Make sure that the instrument is plugged into an outlet socket with a protective earth contact.

Ensure that the AC supply is correctly connected to the line power receptacle. For line power in the range 100 to 240 V~, the PSU automatically selects the appropriate range. No manual voltage-range selection is provided.

Disconnecting device

The detachable power cord is the instrument's disconnecting device, but if the instrument is integrated into a rack or system, an external power switch or circuit breaker is required. Whatever the disconnecting device, make sure that you can reach it easily and that it is accessible at all times.

Standby/on switch

The switch on the front panel is only a standby switch. It is not the line switch, which is on the rear panel.

Fuse

For the AC voltage range of 100 to 240 V~ the fuse rating is T2AL250V. The fuse is a cartridge type measuring 20 mm × 5 mm.

The fuse-holder is integral with the rear panel's 3-pin line power plug. To change the fuse, use a screwdriver to lever out the holder.

Goods-in checks

The following goods-in check confirms that the instrument is functioning correctly, but does not verify conformance to the listed specification. To verify that the instrument conforms to the specification given in Chapter 1, refer to Chapter 6, 'Operational verification testing'.

- 1 Ensure that the correct fuse is fitted (accessible on the rear panel) and connect the instrument to the supply.
- 2 Switch on and check that the amber standby LED lights.
- 3 If the instrument appears to be completely dead, carry out the following:
 - Check that the mains power cord is providing power to the instrument.
 - Check that the mains fuse has not blown.

RS-232 connector

The RS-232 interface built into the instrument is used to download software and firmware. The male D-type RS-232 connector is shown in Fig. 2-1.

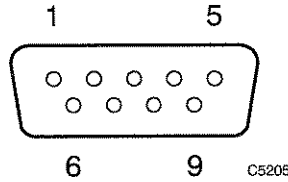

Fig. 2-1 RS-232 connector (looking onto rear panel)

The pin-outs for the 9-way RS-232 connector are shown below:

Contact		Signal
1	DCD	Data carrier detect
2	RXD	Receive data
3	TXD	Transmit data
4	DTR	Data terminal ready
5	SG	Signal ground
6	DSR	Data set ready
7	RTS	Request to send
8	CTS	Clear to send
9	RI	Ring indicator

The RS-232 interface can be connected to a personal computer's AT connector using a null-modem cable. Suitable cables are available — see 'Versions and accessories' in Chapter 1. Connections to both a 9-way and a 25-way serial port on a PC are shown in Fig. 2-2.

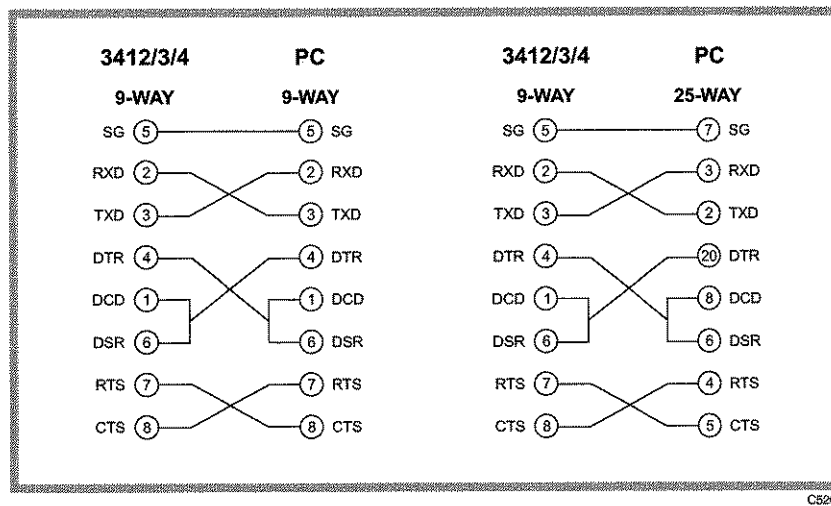

Fig. 2-2 RS-232 cable connections

Auxiliary port connector

The 15-way female D-type AUXILIARY PORT connector is shown in Fig. 2-3. This provides: inputs and outputs for RF A/B level and burst operation; outputs of markers 1, 2 and 3 from an ARB waveform; list mode trigger input and 'in transit' and start marker out. Levels are TTL (HCT). A breakout box (part no. 82542) is available; this converts the D-type connector to BNC male sockets. Breakout box markings are shown in capital letters in the table below.

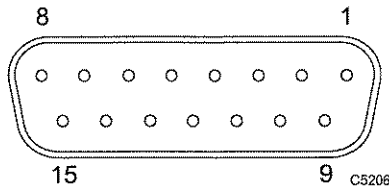

Fig. 2-3 15-way AUXILIARY PORT connector (looking onto rear panel)

The pin-outs for the AUXILIARY PORT connector and breakout box are as follows:

Contact	Function	Breakout box	Contact	Function	Breakout box
1	Burst out	BURST OUT	9	Ground	Ground
2	Not connected	AUXILIARY 1	10	Marker 1 out (power ramp)	MARKER OUTPUTS 1
3	List start mkr out	OUTPUTS MARKER	11	Burst gate in	BURST IN
4	Marker 2 out (A/B)	MARKER OUTPUTS 2	12	Not connected	AUXILIARY 2
5	A/B burst atten control in	BURST A/B	13	Marker 3 out	MARKER OUTPUTS 3
6	List 'in transit' out	OUTPUTS BLANK	14	Not connected	AUXILIARY 3
7	ARB trigger in	ARB TRIG IN	15	List trigger in	AUX TRIG IN
8	Not connected	AUXILIARY 4			

Note: pin 11 (Burst gate in) is connected in parallel internally with rear-panel BNC connector BURST GATE IN.

List mode triggering

The IN TRANSIT output shows that the instrument is changing to the next entry in the list. When IN TRANSIT goes low, the instrument has stabilized at the list entry. START MARKER shows that the instrument has reached the starting point in the list. IN TRANSIT and START MARKER appear whether the list is triggered internally or externally.

You can also trigger a list by using the rear-panel TRIGGER IN BNC connector. +ve trigger is the default, but you can also select -ve trigger.

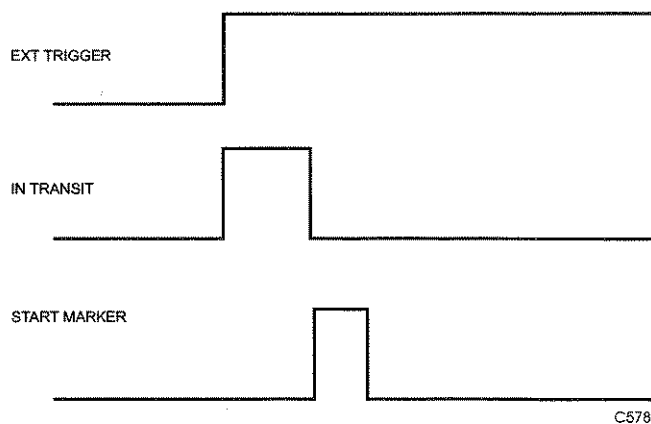

LVDS IN/OUT connector

The LVDS (low-voltage differential signaling) interface to the real-time baseband board (Option 008) can be used to input bit data or symbol data, or input/output 16-bit IQ data, and associated control and timing signals.

The 68-way female SCSI-type LVDS IN/OUT connector is shown in Fig. 2-4. Signals are transmitted using LVDS to ANSI/TIA/EIA-644.



Fig. 2-4 LVDS IN/OUT connector (looking onto rear panel)

The pin-outs for the LVDS connector are as follows:

Contact	Function	Contact	Function	Contact	Function
1	HOP_ADDR0-	24	D15-	47	D4+
2	HOP_ADDR1-	25	IQSELECT_IN-	48	D5+
3	HOP_ADDR2-	26	IQSELECT_OUT-	49	D6+
4	SYMBOLSYNC-	27	SPARE-	50	D7+
5	MASTERSYNC-	28	GND	51	D8+
6	CLK_OUT-	29	MARKER1-	52	D9+
7	GND	30	MARKER2-	53	D10+
8	CLK_IN-	31	MARKER3-	54	D11+
9	D0-	32	MARKER4-	55	D12+
10	D1-	33	HOP_ADDR3-	56	D13+
11	D2-	34	HOP_ADDR4-	57	D14+
12	D3-	35	HOP_ADDR0+	58	D15+
13	D4-	36	HOP_ADDR1+	59	IQSELECT_IN+
14	D5-	37	HOP_ADDR2+	60	IQSELECT_OUT+
15	D6-	38	SYMBOLSYNC+	61	SPARE+
16	D7-	39	MASTERSYNC+	62	GND
17	D8-	40	CLK_OUT+	63	MARKER1+
18	D9-	41	GND	64	MARKER2+
19	D10-	42	CLK_IN+	65	MARKER3+
20	D11-	43	D0+	66	MARKER4+
21	D12-	44	D1+	67	HOP_ADDR3+
22	D13-	45	D2+	68	HOP_ADDR 4+
23	D14-	46	D3+		

LVDS data used as data source (serial mode)

In this mode, data is fed to the LVDS interface using only D0. The CLK_OUT signal runs at eight times the symbol rate as shown below (example — three bits per symbol).

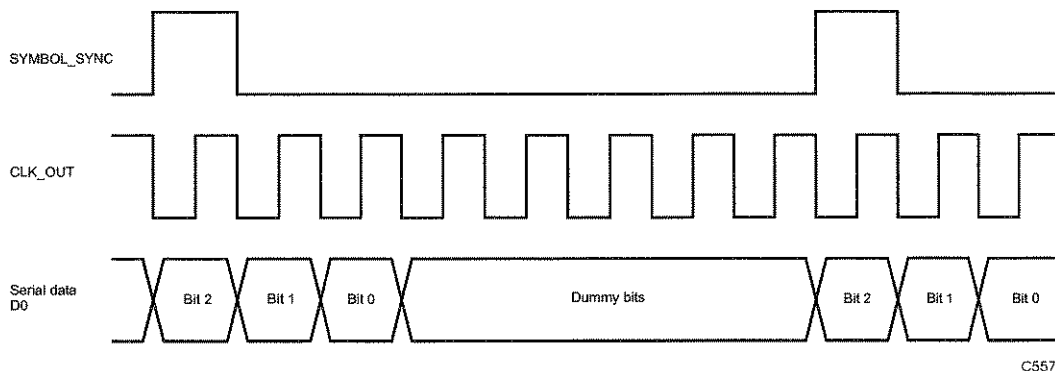

C5576

CLK_OUT and SYMBOL_SYNC are outputs on the LVDS. Data in is latched on the rising edge of CLK_OUT. Alternatively, you can provide the clock using CLK_IN — see *CLK_OUT sync* section on page 2-11.

LVDS data used as data source (parallel mode)

In this mode, data is fed to the LVDS interface using as many LVDS data lines as there are bits per symbol. In other words, if there are four bits per symbol, D0 to D3 are required. The CLK_OUT signal runs at eight times the symbol rate as shown below (example — four bits per symbol).

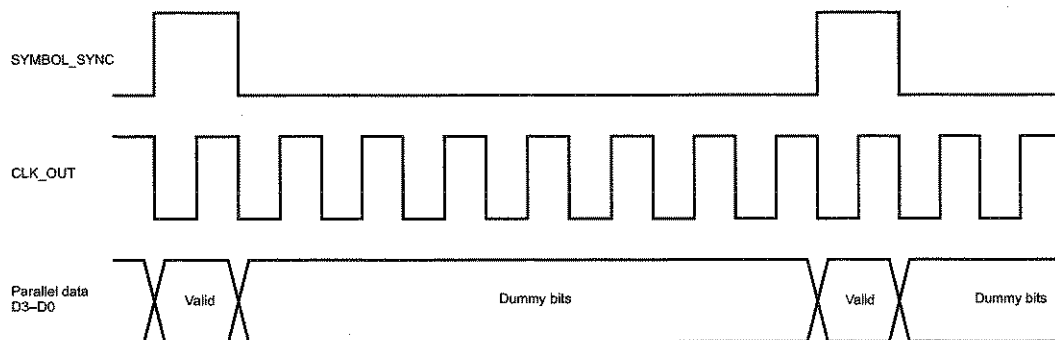

C5684

CLK_OUT and SYMBOL_SYNC are outputs on the LVDS. Data in is latched on the rising edge of CLK_OUT whilst SYMBOL_SYNC is high. Alternatively, you can provide the clock using CLK_IN but SYMBOL_SYNC will always be an output — see *CLK_OUT sync* section on page 2-11.

LVDS data used as IQ input

In this mode, data is fed to the LVDS interface using all 16 LVDS data lines. The LVDS IQSELECT_OUT signal determines whether the data is I or Q (0=Q and 1=I). The CLK_OUT signal runs at twice the I/Q sample rate.

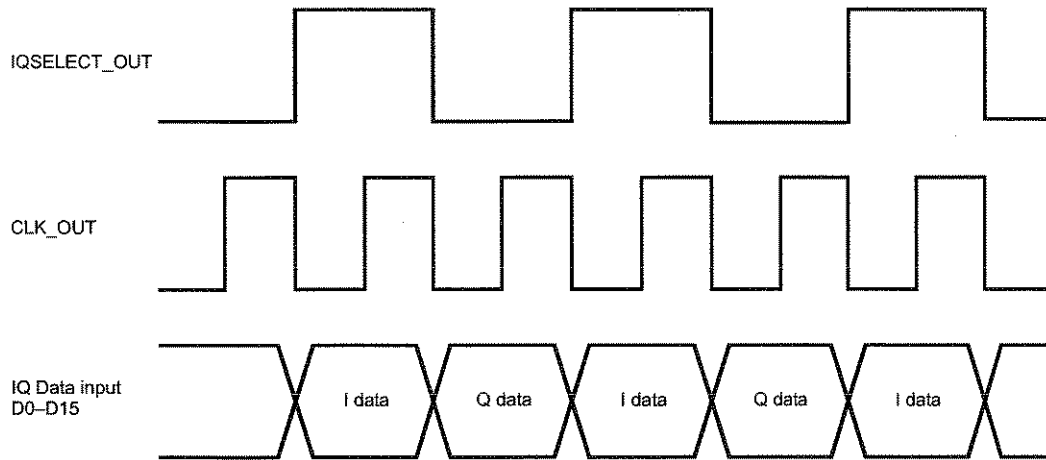

C5728

CLK_OUT and IQSELECT_OUT are outputs on the LVDS. Data in is latched on the rising edge of CLK_OUT. Alternatively, you can provide the clock using CLK_IN and select using IQSELECT_IN — see *CLK_OUT sync* section on page 2-11.

LVDS data used as IQ output

In this mode, data is fed out of the LVDS interface using all 16 LVDS data lines. This is identical to the previous mode except that the data direction is out. The LVDS IQSELECT_OUT signal determines whether the data is I or Q (0=Q and 1=I). The CLK_OUT signal runs at twice the I/Q sample rate.

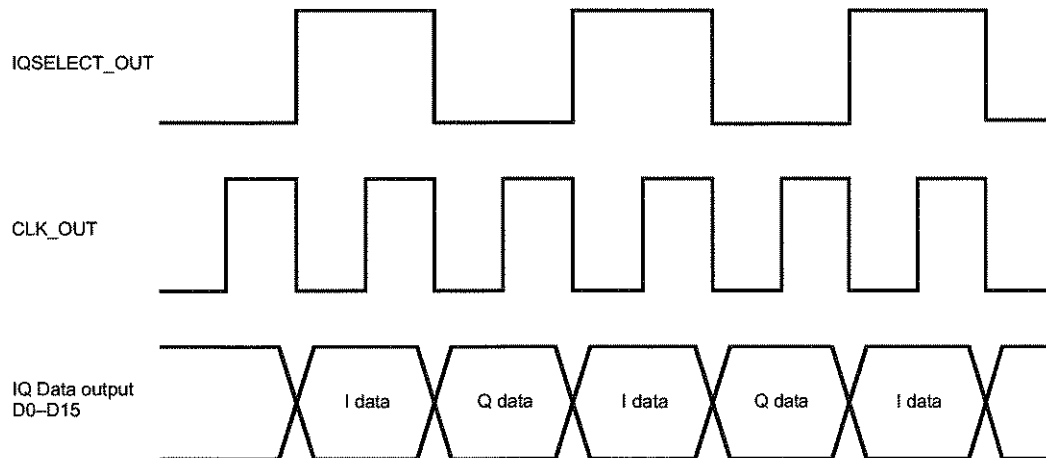

C5729

CLK_OUT and IQSELECT_OUT are outputs on the LVDS. Data out is valid on the rising edge of CLK_OUT.

Markers

There are four markers. Three of them appear as TTL outputs on a D-type connector on the rear panel, and all four appear as outputs or inputs on the 68-way LVDS connector also on the rear panel. The markers can be generated internally or can be read from the LVDS connector. The markers can be used to 'mark' specific sections of the modulated output; for example, the active slot in a GSM frame. However, certain markers also have other functions as shown below.

Marker	Use
1	General purpose / RF Burst control (0=off, 1=on)
2	General purpose / RF level select (A or B)
3	General purpose / Hop address trigger (+ve edge)
4	Not currently used

Hop address

There are five hop address lines and these appear as either outputs or inputs on the LVDS connector. These five lines dictate which frequency offset is used from a lookup table that has been set up internally. As shown above, the hop address is always latched on the rising edge of Marker 3. The hop address can be generated internally by means of a counter. This counter is also updated on the rising edge of Marker 3.

Example 1

Hop address is an input on the LVDS and the first four entries in the lookup table are:

Hop Address	RF offset frequency
0	0 MHz
1	10 MHz
2	-30 MHz
3	50 MHz

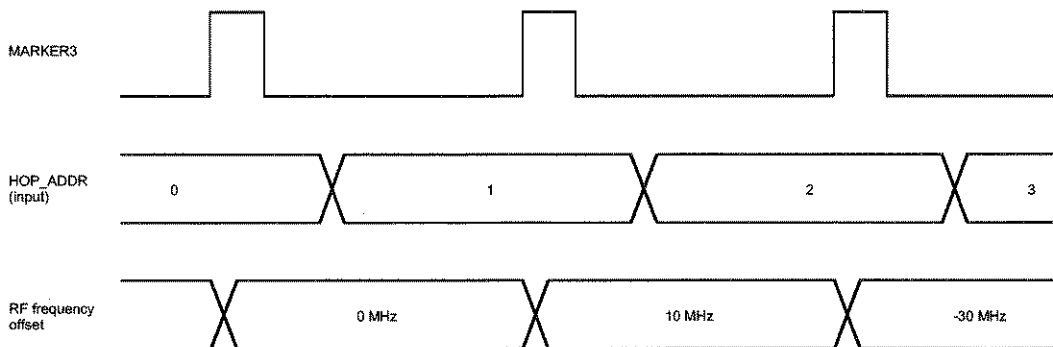

C5686

Example 2

Hop address is generated by the internal counter and appears as an output on the LVDS. The first four entries in the lookup table as before are:

Hop Address	RF offset frequency
0	0 MHz
1	10 MHz
2	-30 MHz
3	50 MHz

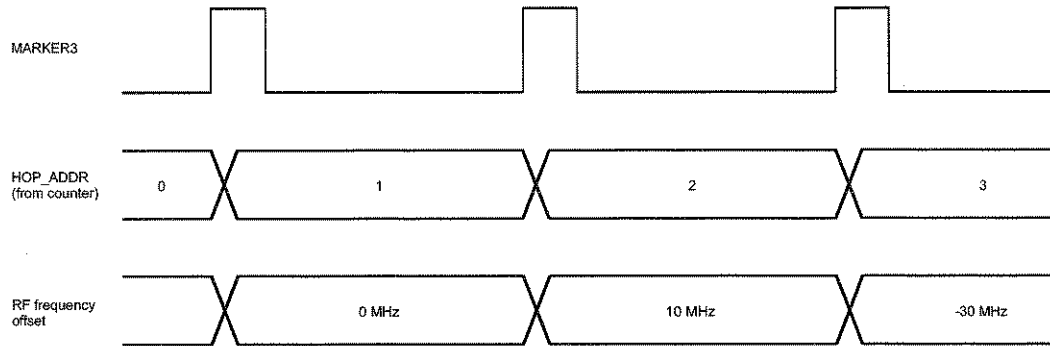

C5687

Note: Because the values that appear on the LVDS hop address lines are from the internal counter, they seem to be out of step with respect to the RF frequency offset. This is because the value from the counter is latched on the rising edge of Marker 3, but the counter itself is also incremented on the same rising edge. Therefore the hop address output will be one step ahead of the RF frequency offset.

CLK_OUT sync

Although all the timing of the LVDS interface is based around CLK_OUT, you also can provide an input clock. This is fed into the CLK_IN input on the LVDS connector. The LVDS interface does not use CLK_IN for its timing but there is the facility to synchronize CLK_OUT to CLK_IN. Once synchronized, the two clocks remain in phase provided that the following conditions are met:

- The 3410 Series instrument and the source are running from the same 10 MHz standard, and
- All sample rates between the instrument and the source are the same.

If I/Q data is being fed into the LVDS connector then it is important that IQSELECT between the instrument and the source are also in synchronization. In this mode, you must provide IQSELECT_IN as well as CLK_IN before they can be synchronized. As before, the instrument does not use CLK_IN or IQSELECT_IN but merely synchronizes CLK_OUT and IQSELECT_OUT to these signals.

Routine safety testing and inspection

Aeroflex's products are tested prior to delivery to ensure that they comply with the requirements of IEC 61010-1 (BS EN61010-1). We advise that products are routinely inspected and tested to ensure that they have no faults and continue to meet their specifications.

Safety critical components should only be replaced with equivalent parts, using techniques and procedures recommended by Aeroflex.

Aeroflex designs and constructs its products in accordance with International Safety Standards such that in normal use they represent no hazard to the operator. Aeroflex reserves the right to amend the above information in the course of its continuing commitment to product safety.

Cleaning

Before starting any cleaning, switch off the instrument and disconnect it from the supply.

Case exterior: use a soft cloth moistened with water to clean the case; do not use aerosol or liquid solvent cleaners.

Touch screen: take care not to scratch the touch-panel overlay during use or when cleaning. Clean the touch panel by wiping a slightly damp, soft, lint-free cloth gently over the surface.

Putting into storage

If you are putting the instrument into storage, ensure that the following conditions are maintained:

Temperature range:	-40 to 71°C (-40 to 163°F)
Pressure	570 mbar (4570 m/15 000 ft)

Chapter 3

LOCAL OPERATION

Contents

Introduction.....	3-3
How to use the manual.....	3-3
Conventions	3-3
Headers	3-3
References to remote operation commands	3-3
Index	3-3
Controls, connectors and display	3-4
Front-panel connectors and standby/on switch	3-5
Keyboard.....	3-6
Rear-panel connectors.....	3-9
GETTING STARTED.....	3-11
Switching on	3-11
How to select functions.....	3-12
Main functions	3-12
Sub-menus.....	3-12
Soft tabs	3-13
Soft boxes.....	3-13
An example	3-14
The starting point	3-14
Setting the carrier frequency	3-14
Setting RF level.....	3-15
Setting analog modulation	3-15
Using the $\times 10$ and $\div 10$ keys	3-18
Using rotary control	3-18
Using steps	3-19
DETAILED OPERATION.....	3-21
Carrier frequency and RF level.....	3-21
Carrier frequency menu — <Freq>.....	3-21
The RF ON/OFF key.....	3-22
Carrier frequency menu — <Phase>.....	3-23
The Δ key.....	3-24
RF level menu — <Lev>	3-25
RF level menu — <ALC>.....	3-28
RF level menu — <Offsets>	3-30
Modulation summary	3-33
Internal IQ modulation — ARB option.....	3-35
Internal IQ set-up (ARB operation)	3-36
ARB waveform set-up	3-39
Internal (ARB) and external burst modulation set-up	3-46
Internal IQ modulation — real-time baseband option.....	3-53
Configure internal IQ — format	3-54
Internal IQ set-up	3-55
Generic modulation set-up	3-57
Tones set-up	3-62
Internal (RTBB) and external burst modulation set-up	3-64
Frequency hopping.....	3-72
Differential IQ outputs	3-77
Differential IQ waveform set-up	3-81
External IQ modulation — analog or digital.....	3-83
External IQ set-up — analog.....	3-84
External IQ set-up — digital (real-time baseband Option 008 only)	3-87

Analog modulation.....	3-91
Path set-up.....	3-92
AM1 set-up	3-93
AM2 set-up	3-95
FM1 set-up.....	3-96
FM2 set-up.....	3-98
ΦM1 set-up	3-99
ΦM2 set-up	3-101
Internal source set-up.....	3-102
External source set-up.....	3-105
Pulse modulation set-up.....	3-107
Sweep.....	3-109
Sweep menu — <Config>.....	3-109
Sweep menu — <Params>.....	3-111
Sweep menu — <Control>	3-113
List mode sweep	3-115
List sweep menu — <Config>.....	3-115
List sweep menu — <Params>	3-117
List sweep menu — <Control>.....	3-118
Memory.....	3-123
Save — saving configurations to memory	3-123
Recall — retrieving stored settings from memory	3-124
Reverse power protection.....	3-125
Resetting the RPP	3-125
Error status.....	3-127
Remote operation.....	3-129
Return to local operation.....	3-129
UTILITIES	3-131
Storing settings.....	3-131
■ <i>System</i>	3-132
■ System: Remote Config.....	3-132
■ System: RS-232 Config.....	3-134
■ System: LAN Config.....	3-136
■ System: Ref. Oscillator.....	3-138
■ System: RF Level Units.....	3-141
■ System: Power-On Status	3-142
■ <i>Display/Kybd</i>	3-144
■ Display/Kybd: LCD Adjust	3-144
■ Display/Kybd: Touch Panel.....	3-145
■ Display: Blanking	3-145
■ <i>Diagnostics</i>	3-147
■ Diagnostics: Inst. Status.....	3-147
■ Diagnostics: Operating Time	3-149
■ Diagnostics: Build Config.....	3-150
■ Diagnostics: Latch Access	3-150
■ Diagnostics: Attenuator (not available if Option 001 is fitted).....	3-150
■ <i>Security</i>	3-152
■ Security: Lock/Unlock.....	3-152
■ Security: Memory Clear.....	3-153
■ Security: Kybd Lock.....	3-154
■ <i>Calibration</i>	3-155
Default settings	3-156
Error messages.....	3-157
2023 emulation.....	3-161
Format of ARB files.....	3-164
General.....	3-164
An example showing data rates and sizes for an IS-95 waveform.....	3-165
Virtual front panel.....	3-167

Introduction



This chapter introduces you to your instrument's controls and connectors. It then takes you through a simple set-up exercise to provide some familiarity with operating the instrument from the front panel, followed by detailed instructions.

For remote operation, programming using the built-in GPIB interface is covered in Chapter 4.

How to use the manual

Conventions

The following conventions are used in this manual:

- RF OUTPUT Markings on the instrument are shown in capitals.
-  Hard keys are shown like this.
- RF Level* Text that appears on the screen is shown in italics.
- <FM> Soft tabs, which appear at the foot of the screen, are shown in brackets and italics.
-  Touch-sensitive areas appear as they do on the screen.

Note: Representations of the instrument's screen are shown as inverted video (that is, as black text on a white background) in this manual.

Headers

Small graphics in the header supplement the text by giving an 'at a glance' reminder of the path by which you arrived at the functions on that page.

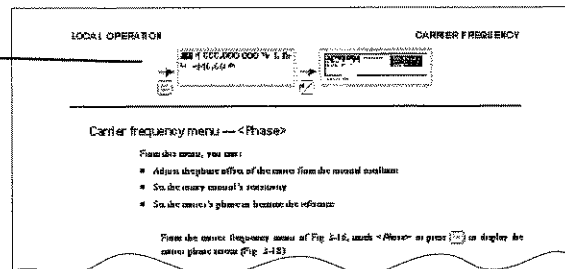

References to remote operation commands

Where relevant, each individual function is shown with its corresponding remote operation command and a reference to the relevant page for details.

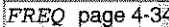

For example:

■ Carr Freq  page 4-34



Index

There is a comprehensive index at the end of the manual.

Controls, connectors and display

You select a function initially by touching the display screen, either on the 'function label' (see box) or the parameter value of interest. The chosen function label is highlighted. Alternatively, you can use the  and  keys to move around the screen.

You select parameters using the keyboard keys (which have their functions printed on them), the numeric keypad or the control knob.

The numeric keys are used to set parameters to specific values, which can also be varied in steps of any size by using the  and  keys or the control knob.

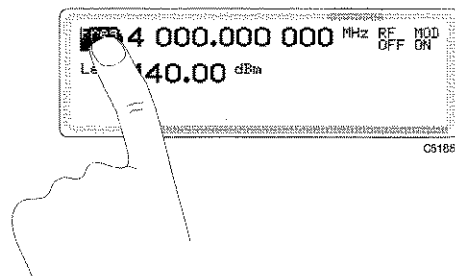

The screen can display three different types of touch area.

Function labels look like this  and reveal further sub-menus once you touch them, or their associated text or parameter values.

Soft boxes look like this  and when touched, expand to reveal summarized information about the named function.

Soft tabs appear at the foot of the screen and reveal further parameters once you touch them.

See page 3-12.

Front-panel connectors and standby/on switch

Front-panel connectors and the standby/on switch are shown in Fig. 3-1 below.

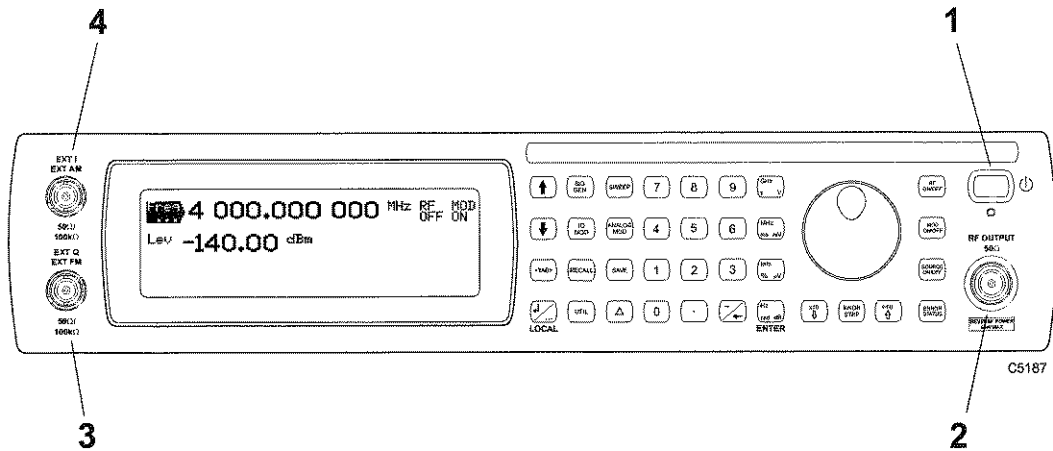

Introduction

Fig. 3-1 Front panel

- | | | |
|---|------------------------------|--|
| 1 | Standby/on switch | <p>Switches the instrument between the on and standby modes, using a press on, press off action. To prevent accidental operation, this switch has a built-in time delay of about half a second before it is recognized.</p> <p>The adjacent LED is amber during standby, showing that power is applied to the crystal oscillator. The LED turns green when the instrument is fully powered up.</p> <p>Use the power supply switch on the rear panel (page 3-9) to isolate the instrument from AC line power.</p> |
| 2 | RF OUTPUT | <p>50 Ω N-type socket.</p> <p>3412, 3413, 3414 are protected against the application of reverse power of up to 50 W (to 3 GHz) or 25 W (to 4 GHz) from a 50 Ω source. Protection remains active when the AC line power is removed from the instrument.</p> <p>CAUTION 3416 has no reverse power protection. Maximum reverse power for 3416 is 0.5 W.</p> <p>Option 007 locates this socket on the rear panel.</p> |
| 3 | EXT Q/EXT FM

Q/FM OUT | <p>Q input or external frequency modulation input (1 V rms or 1 V pk-pk). BNC socket, selectable 50 Ω/100 kΩ.</p> <p>Option 007 only. 50 Ω BNC socket, 1 V RMS: outputs the Q signal from the ARB or the output of the FM source.</p> |
| 4 | EXT I/EXT AM

I/AM OUT | <p>I input or external amplitude modulation input (1 V rms or 1 V pk-pk). BNC socket, selectable 50 Ω/100 kΩ.</p> <p>Option 007 only. 50 Ω BNC socket, 1 V RMS: outputs the I signal from the ARB or the output of the AM source.</p> |

Keyboard

The keyboard is functionally color-coded:

- Keys for navigating around the screen are light blue
- Keys for numeric entry and incrementing/decrementing are white
- Remaining keys are dark gray.

Fig. 3-2 identifies all the items on the keyboard.

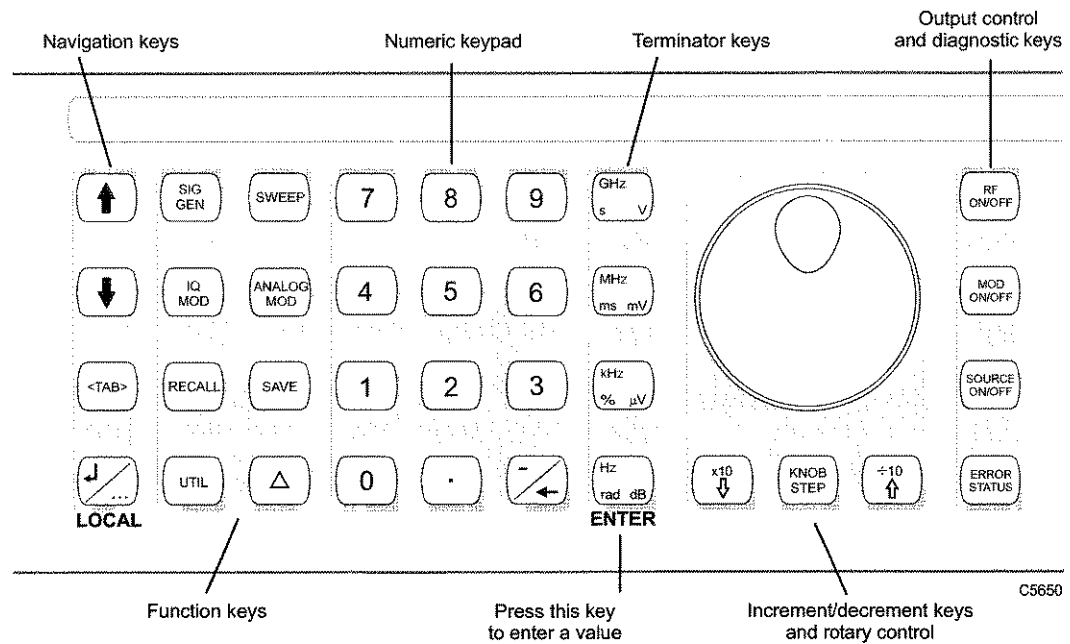

Fig. 3-2 Keyboard

Navigation keys



Scrolls backwards through a menu list or selects the previous main-screen function.



Scrolls forwards through a menu list or selects the next main-screen function.



Selects the next 'soft tab'.

With the main screen displayed, scrolls through the modulation summary list.











LOCAL

Enters/exits a function's sub-menu.

Transfers control from remote operation to front-panel operation (local lockout not asserted).

Function keys

	Displays the main signal generator menu.
	Displays the sweep menu.
	Displays the IQ modulation setup menu.
	Displays the analog modulation setup menu.
	Recalls a previously stored instrument setting from memory.
	Saves the current instrument settings in memory.
	Displays the utilities menu.
	Displays the total shift/increment menu.
	Use this to:
	inspect the total shift from the last keyed-in value
	change the step size
	transfer the current value as the keyed-in value
	return the setting to the last keyed-in value.

Numeric keypad

	For entering the value of a selected parameter.
	Minus sign/backspace key: enters a minus sign or deletes the last character input.

Terminator keys

Units keys	} Determine the units of the set parameters; also, the last of these four keys (ENTER) is used to terminate a unitless entry, to confirm a selection, or to enter μ s units.
ENTER	

Increment/decrement keys and rotary control

Control knob When enabled by the [KNOB/STEP] key, adjusts the value of the selected parameter.



When KNOB is enabled, increases the knob resolution by a factor of 10.

When STEP is enabled, increments the current function by one step.



Switches between enabling the control knob and step operation.



When KNOB is enabled, decreases the knob resolution by a factor of 10.

When STEP is enabled, decrements the current function by one step.

Output control and diagnostic keys

Toggles the RF output on and off.



Toggles all modulation on and off, overriding any individual modulation paths currently selected. *MOD ON* or *MOD OFF* is displayed on the main screen.



Toggles the current modulation path on and off.



Displays the error status menu, which provides additional diagnostic information.

Rear-panel connectors

The rear-panel connectors are shown in Fig. 3-3 below.

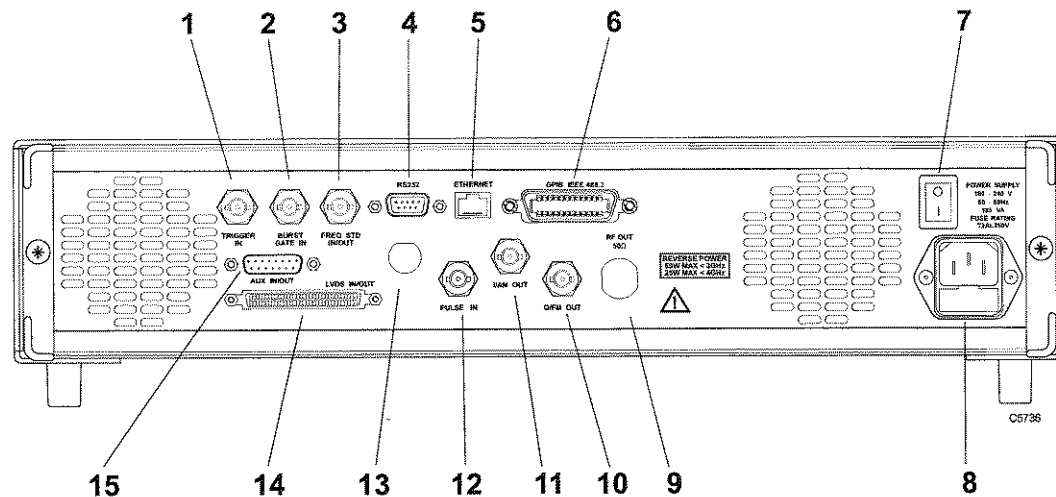

Fig. 3-3 Rear panel

- | | | |
|----|---|--|
| 1 | TRIGGER IN | 50 Ω BNC socket (TTL): accepts a sweep (frequency/level or list mode) trigger input. Pull-up resistor. |
| 2 | BURST GATE IN | 50 Ω BNC socket (TTL): a burst control signal triggers analog ramp-up or ramp-down of RF level.
If generated internally by the ARB, the burst control signal is output from this connector. |
| 3 | FREQ STD IN/OUT | BNC socket, 300 mV to 1.8 V RMS into 1 k Ω : for the input of external standard frequencies of either 1 MHz or 10 MHz. Can also supply a 2 V p-p 10 MHz internal standard output from 50 Ω . |
| 4 | RS232 | 9-way connector for remote operation and downloading software upgrades. For contact allocation see Chapter 2. |
| 5 | ETHERNET | LAN connector for remote programming using VXI-11 protocol. Not fitted to some instruments. |
| 6 | IEEE 488.2 | 24-pin socket accepts the standard GPIB connector to allow remote operation of the instrument. |
| 7 | Power supply switch | Isolates the instrument from the AC line power supply. |
| 8 | Power supply receptacle | 3-pin plug integral with fuse holder. |
| 9 | RF OUTPUT | Option 007 only. Replaces the front-panel 50 Ω N-type socket. |
| 10 | Q/FM OUT
EXT Q/EXT FM | 50 Ω BNC socket, 1 V RMS: outputs the Q signal from the internal baseband source or the output of the FM source.
Option 007 only. Q input or external frequency modulation input. BNC socket, selectable 50 Ω /100 k Ω . |
| 11 | I/AM OUT
EXT I/EXT AM
\bar{Q} OUT | 50 Ω BNC socket, 1 V RMS: outputs the I signal from the internal baseband source or the output of the AM source.
Option 007 only. I input or external amplitude modulation input. BNC socket, selectable 50 Ω /100 k Ω .
Option 009 only. Opposite polarity, equal magnitude to Q signal on Q/FM OUT. |

12	PULSE IN	50 Ω BNC socket: accepts a pulsed input. TTL logic '1' (2 to 5 V) turns the carrier on, logic '0' (0 to 0.8 V) turns it off. Maximum input is ± 10 V.
	I/AM OUT	Option 009 only. 50 Ω BNC socket, 1 V RMS: outputs the I signal from the ARB or the output of the AM source.
13	I OUT	Option 009 only. Opposite polarity, equal magnitude to I signal on I/AM OUT.
14	LVDS IN/OUT	68-way connector inputs/outputs symbol data; IQ data; timing/control signals. For contact allocation see Chapter 2.
15	AUX IN/OUT	25-way connector inputs/outputs burst gate control signals; A/B level burst attenuation control signals; ARB trigger; markers. For contact allocation see Chapter 2.

GETTING STARTED

Switching on

- Check that no external signal sources are connected.
- Switch on the power on/off switch on the rear panel.

This supplies power to the instrument, which is now in standby mode (the LED on the front panel lights up amber).

- Press the supply switch on the front panel until the LED lights up green and the instrument powers up.

The instrument displays a welcome screen, followed by a screen of instrument details (instrument and software version), a self-test, and then the main SIG GEN screen. Fig. 3-4 shows the main screen as it first appears during normal operation. The default maximum frequency shown is 2, 3, 4 or 6 GHz, depending on your instrument.

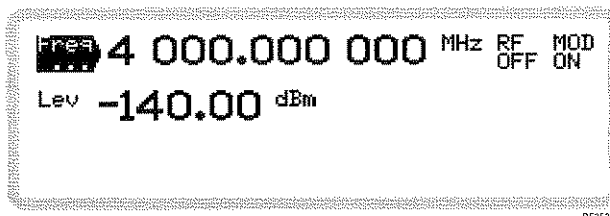

Fig. 3-4 Main screen, showing default display

Your screen doesn't look like this?

If a main screen similar to that shown in Fig. 3-4 does not appear, a previous user may have configured the instrument to recall one of the user memories at power-on, rather than using the factory default settings shown on page 3-156.

To reset to the factory default settings, follow the procedure on page 3-143 or use the 'Quick preset' shown here.

This procedure does not change the power-on settings, so there is no danger of disrupting the previous user's set-up!

Quick preset

- 1 Press the **UTIL** key to display the utilities screen.
- 2 Use the **↓** and **↑** keys to highlight **System**.
- 3 Display the power-on status screen by pressing **4** on the numeric keypad.
- 4 Touch the **<Preset>** tab at the bottom of the screen.
- 5 Touch the **Preset Instrument** soft box, followed by one of the four **ENTER** keys.
- 6 The instrument's hardware configuration immediately changes to the factory default settings.

How to select functions



Whilst we believe that you will find the instrument's touch screen easy and efficient to use, there are also simple keyboard equivalents for each operation. These are mentioned in the text, where relevant.

Main functions

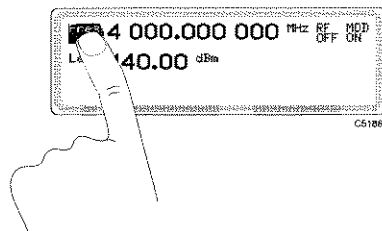
Touch the function label on the screen — for example, **Freq**. The label is highlighted, showing that the function is active.





When the label of a main function — carrier frequency, RF level, modulation, modulation path — is highlighted on the screen, you can change the displayed value by simply entering a new value. Terminate the entry with the appropriate units key.

Keyboard control: use  and  to move the highlighting up and down the screen.

Sub-menus

The three dots on a highlighted function label — for example, **Freq** — show that a sub-menu exists for that function, giving you access to further parameters.

Press  to see the sub-menu, and to return again. A '' symbol appears in the corner of the display to show that this key is active.

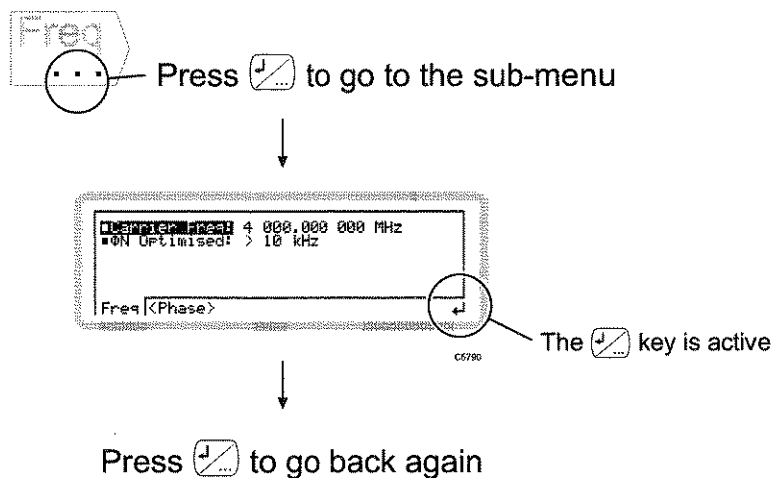

You may see three dots instead of the '' symbol when setting up the modulation mode.

Soft tabs

Soft tabs appear at the bottom of the screen.

Touch these to select them, or use to scroll through them.

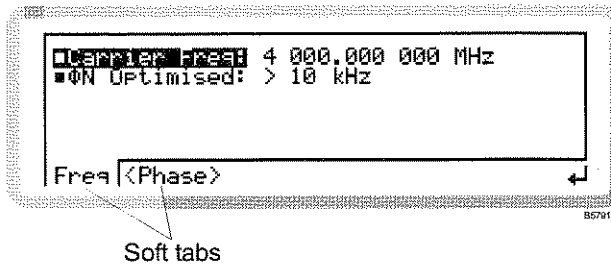

Soft boxes

Soft boxes can appear anywhere on the screen. Mostly, they allow you to control operations (for example, sweeping) or provide choices of configurations (for example, between different sorts of modulation).

To select a soft box:

- Touch it
- or
- enter, on the numeric keypad, the number shown in the corner of the soft box — the keypad command.

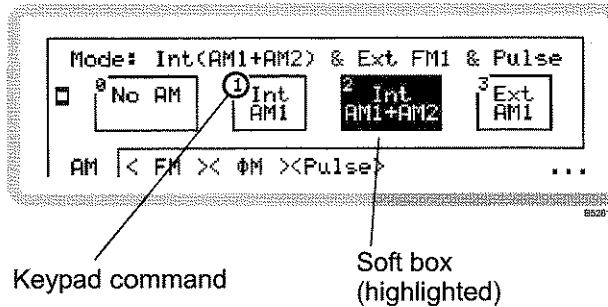

An example

To help you quickly become familiar with the basic operation of the instrument, try the following exercise, which demonstrates how to set up a typical signal with these parameters:

Carrier frequency: 100 MHz
 Output level: -10 dBm
 Frequency modulation: 100 kHz deviation at 500 Hz modulation.

Once you have done this exercise once, you are unlikely to need it again — the instrument is very intuitive to use!

The starting point

Press  to see the main screen. Use this key at any time to view the current status of the instrument.

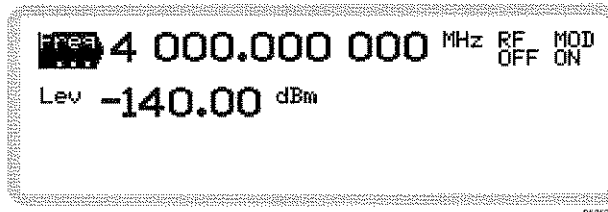



Fig. 3-5 Main screen

Setting the carrier frequency

- 1 Touch  to select carrier frequency as the current function.
- 2 Use the numeric keypad to enter 100 MHz, by keying in **100** and terminating with the  key.
- 3 The frequency displayed changes to *100.000 000 MHz*.

Error message

If an error number (for example, *Err 100*) is displayed, it can be canceled by a correct entry (for example, by entering a value that is within limits).





A complete list of error messages starts on page 3-157.

Backspace key

If you make a mistake when keying in, press the backspace key  and re-enter the correct value.

You can also clear the entire entry by reselecting the function.

Setting RF level

- 1 Touch  to select RF level as the current function.
- 2 Use the numeric keypad to enter -10 dBm, by:
 pressing 
 keying in **10**
 and terminating with the  key.
- 3 The RF level displayed changes to *-10.0 dBm*.
- 4 Pressing  toggles between the RF output on and off, as shown by *RF ON* and *RF OFF* on the screen. Select *RF ON*.

A 100 MHz, -10 dBm RF carrier now appears at the RF OUTPUT socket.

Setting analog modulation

- 1 Press , which displays the modulation mode screen.

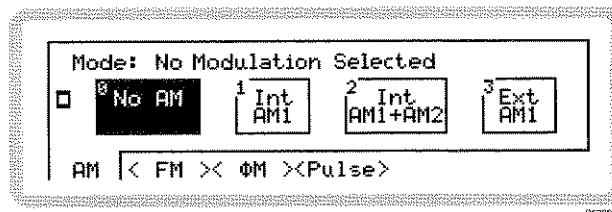

Fig. 3-6 AM modes

- 2 Touch the *<FM>* soft tab to display the available FM modulation modes.

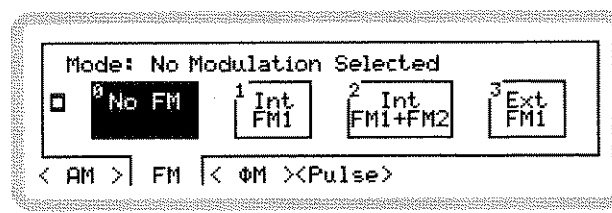



Fig. 3-7 FM modes

- 3 Touch  to select a single internal FM path.
- 4 Press  to see the selected modulation mode.

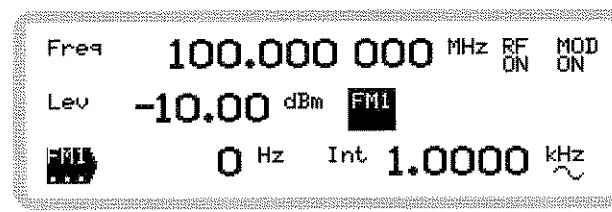



Fig. 3-8 The main screen with FM selected

- 5 Touch **FM1** and press , which takes you to the sub-menu to set up the FM path. The modulation deviation field is highlighted.

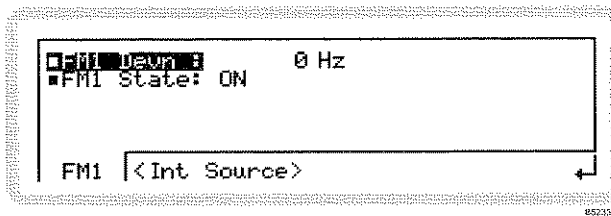



Fig. 3-9 FM1 sub-menu — deviation

- 6 Use the numeric keypad to enter 100 kHz, by:
keying in **100**
and terminating with the  key.
- 7 The FM1 deviation displayed changes to *100 kHz*.
- 8 Press  to move down one line on the screen.

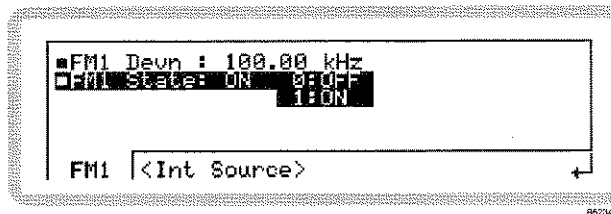

Fig. 3-10 FM1 sub-menu — state

- 9 Press **1** on the numeric keypad to switch ON the FM path (it should already be on by default, unless the instrument's power-up parameters have been changed).
- 10 Touch the *<Int Source>* soft tab. This displays the sub-menu to set up the internal modulation path, with the frequency field *Int Freq* highlighted.

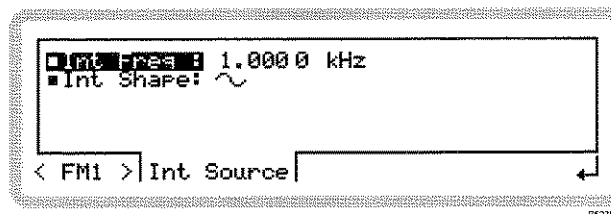



Fig. 3-11 FM1 sub-menu — internal path frequency

- 11 Use the numeric keypad to enter 500 Hz, by:
keying in **500**
and terminating with the  key.
- The modulation frequency displayed changes to *500 Hz*.

- 12 Press  to move down one line on the screen.

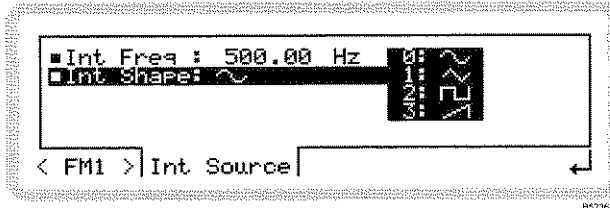





Fig. 3-12 FM1 sub-menu — internal path shape

- 13 Press **0** on the numeric keypad to select a sine wave (it should already be selected by default, unless the instrument's power-up parameters have been changed).
- 14 Press  to see this summarized on the main screen.
- 15 Pressing  toggles the modulation source on and off, as shown by  and  on the screen. Turn the modulation source on.

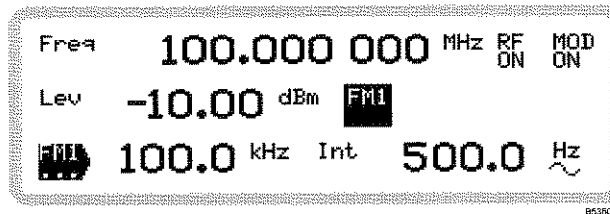



Fig. 3-13 The main screen, FM source on

- 16 Turn the overall modulation on by pressing  (it should already be selected by default, unless the instrument's power-up parameters have been changed).

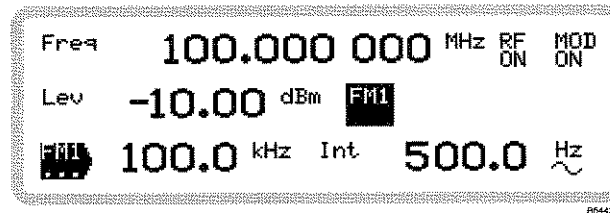

Fig. 3-14 The fully set-up main screen, modulation and RF output on

A 100 MHz, -10 dBm carrier, with 100 kHz deviation, modulated at 500 Hz, now appears at the RF OUTPUT socket.

Using the $\left(\begin{smallmatrix} \times 10 \\ \downarrow \end{smallmatrix}\right)$ and $\left(\begin{smallmatrix} +10 \\ \uparrow \end{smallmatrix}\right)$ keys

When you have entered a value using the numeric keypad, you can adjust its value either in single or continuous steps.

As an example, we shall adjust the carrier frequency using the rotary control for continuous adjustment as well as in selected increments/decrements using single steps.

Touch $\left(\begin{smallmatrix} \text{Freq} \\ \dots \end{smallmatrix}\right)$ to select carrier frequency as the current function. The frequency is displayed as 100.000 000 MHz. The number of digits behind the decimal point shows the maximum resolution: the frequency can be changed in 1 Hz steps.

Using rotary control

- 1 Select rotary control adjustment by toggling the $\left(\begin{smallmatrix} \text{KNOB/STEP} \end{smallmatrix}\right)$ key so that a bracket underlines the carrier frequency. With the bracket displayed, the control knob is enabled and its sensitivity can be set.
- 2 Adjust rotary control sensitivity by pressing either the $\left(\begin{smallmatrix} \times 10 \\ \downarrow \end{smallmatrix}\right)$ key or the $\left(\begin{smallmatrix} +10 \\ \uparrow \end{smallmatrix}\right)$ key. Pressing the $\left(\begin{smallmatrix} +10 \\ \uparrow \end{smallmatrix}\right)$ key increases the length of the bracket by one decimal place. Pressing the $\left(\begin{smallmatrix} \times 10 \\ \downarrow \end{smallmatrix}\right)$ key shortens the length of the bracket by one decimal place. In this way, rotary control resolution decreases or increases by a factor of ten.

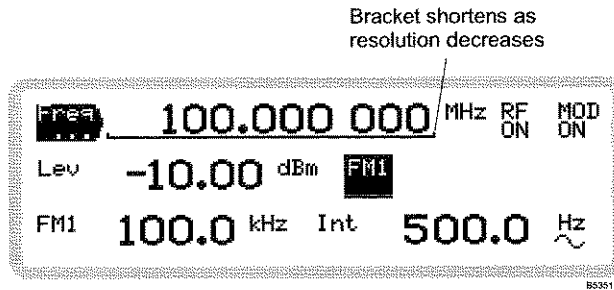

Fig. 3-15 Resolution of the rotary control

- 3 Move the control knob in either direction and note how the displayed carrier frequency changes by the desired amount.
- 4 To check the current amount of offset from the reference carrier frequency, press $\left(\begin{smallmatrix} \Delta \end{smallmatrix}\right)$. The offset is displayed as either a negative or positive value.

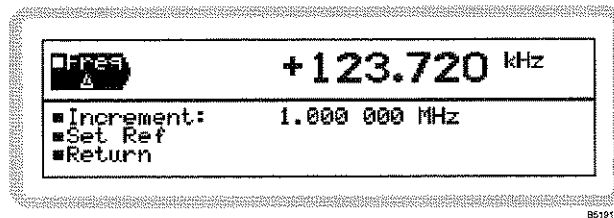

Fig. 3-16 Carrier shift and increment

- 5 Press $\left(\begin{smallmatrix} \text{SIG} \\ \text{GEN} \end{smallmatrix}\right)$ to return to the main screen.

Using steps

- 1 Press $\left[\begin{smallmatrix} \text{KNOB} \\ \text{STEP} \end{smallmatrix} \right]$ to disable the rotary control adjustment (the bracket under the carrier frequency disappears).
- 2 Press $\left[\Delta \right]$. Scroll down to *Increment* using the $\left[\downarrow \right]$ navigation key. Enter the size of frequency step using the numeric keypad, and terminate with the [MHz], [kHz] or [Hz] key. The instrument now uses this new value of step size.
- 3 Press $\left[\begin{smallmatrix} \text{SIG} \\ \text{GEN} \end{smallmatrix} \right]$ to return to the main screen.
- 4 Now press the $\left[\begin{smallmatrix} \times 10 \\ \downarrow \end{smallmatrix} \right]$ and $\left[\begin{smallmatrix} +10 \\ \uparrow \end{smallmatrix} \right]$ keys repeatedly and note how the displayed carrier frequency changes in steps of the increment that you have just set. Holding either of these keys pressed provides continuous stepping.
- 5 In the same way as for rotary control operation, you can check the current amount of offset from the reference carrier frequency by pressing $\left[\Delta \right]$.

And that's about it!

These few pages have shown you the fundamentals of operating the instrument — which apply throughout the manual. We hope and believe that you will find operation intuitive and simple.

If you need help, just refer back to these pages.

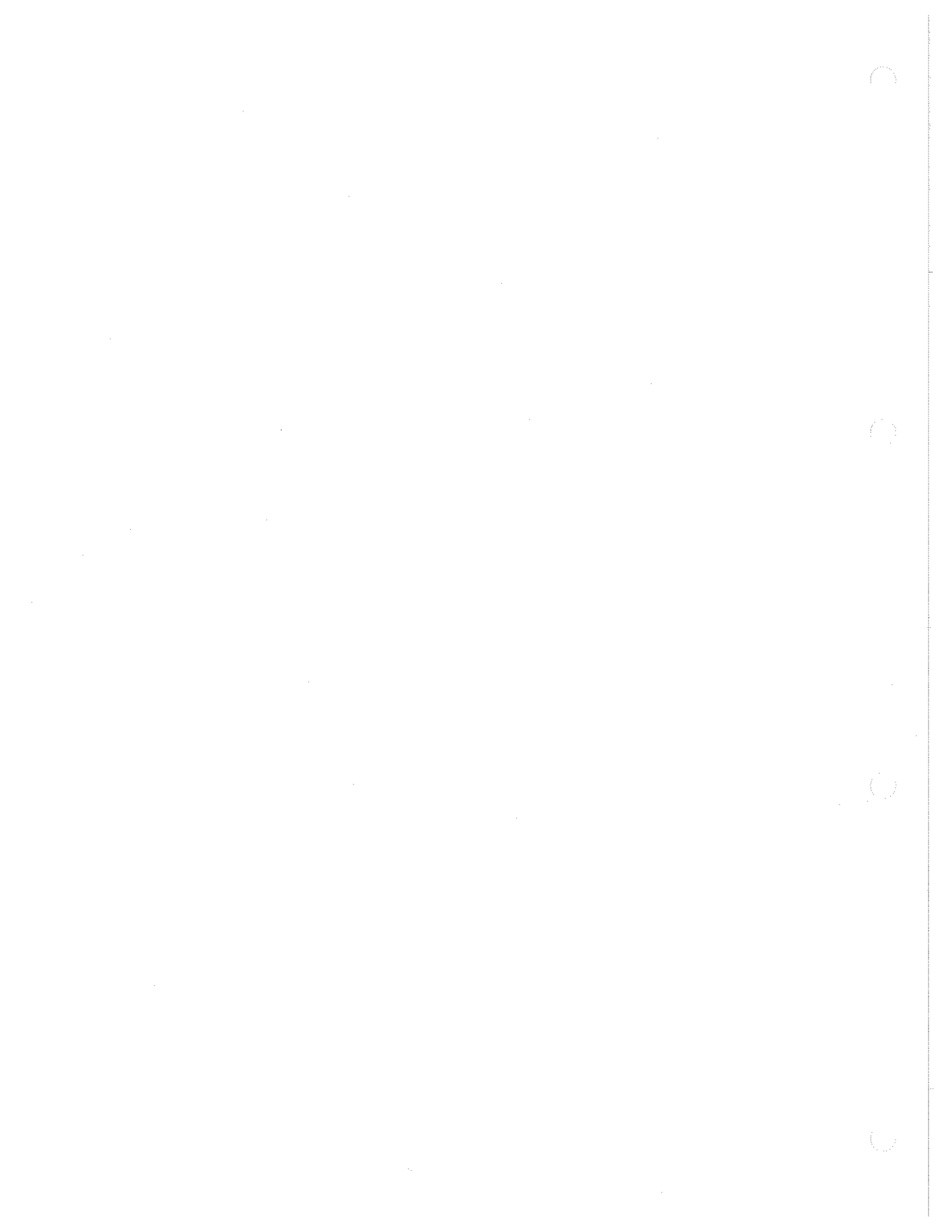

DETAILED OPERATION

Carrier frequency and RF level

Press **SIG GEN** to see the main screen (Fig. 3-17), from which you can set up parameters associated with the instrument's carrier frequency and RF level.

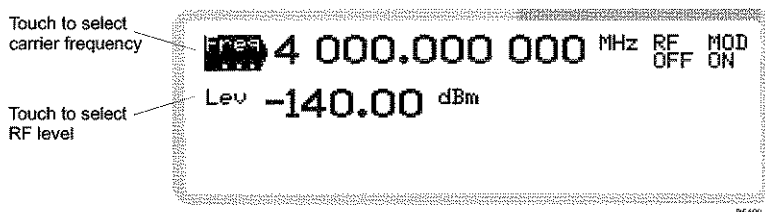

Fig. 3-17 Main screen

Set carrier frequency or RF level directly:

- 1 Touch the relevant function label on the screen (**Freq** or **Lev**) or the displayed value.
- 2 Enter the value using the numeric keypad. Terminate using the appropriate units key.
- 3 You can adjust the value displayed, either in steps or by using the rotary control for continuous adjustment.

Carrier frequency menu — <Freq>

Use this menu to set the carrier frequency and phase noise performance.

- 1 Touch **Freq** to select the carrier frequency menu.
- 2 Press **↓** to view the sub-menus. *Carr Freq* is highlighted (Fig. 3-18).

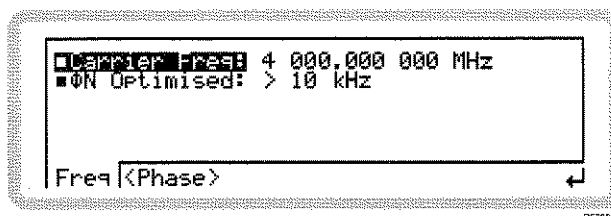
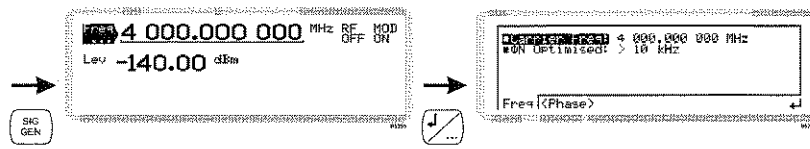

Fig. 3-18 Carrier frequency sub-menu



■ Carr Freq

FREQ page 4-34

You can enter a carrier frequency in the range

250 kHz–2 GHz 3412
 250 kHz–3 GHz 3413
 250 kHz–4 GHz 3414
 250 kHz–6 GHz 3416

to a resolution of 1 Hz. Press the appropriate units key to terminate.

■ Φ N Optimised

FREQ: PHAS: OPT page 4-36

You can choose the most suitable phase noise performance:

- >10 kHz optimizes the phase noise more than 10 kHz away from the carrier frequency.
Gives slower settling of the synthesizer.
- <10 kHz optimizes the phase noise less than 10 kHz away from the carrier frequency.
Gives faster settling of the synthesizer.
Gives fast switching speed during list mode operation.

The RF ON/OFF key

OUTP page 4-25

Switch the carrier *ON* or *OFF* at any time using .

This turns the RF output on and off, whilst retaining the 50 Ω output impedance.

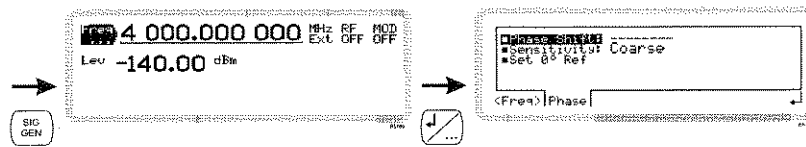

Carrier frequency menu — <Phase>

From this menu, you can:

- Adjust the phase offset of the carrier from the internal reference oscillator
- Set the rotary control sensitivity
- Set the carrier's phase as the reference.

From the carrier frequency menu of Fig. 3-18, touch <Phase> or press **<TAB>** to display the carrier phase screen (Fig. 3-19).

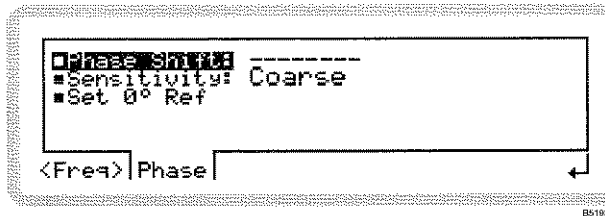

Fig. 3-19 Carrier phase

■ Phase Shift

FREQ: PHAS page 4-35

Adjust the phase offset of the carrier, which is displayed on the screen, using the control knob.

Tip: If you subsequently change the carrier frequency, the established phase relationship is upset, and dashes appear on the display to indicate this.

■ Sensitivity

FREQ: PHAS: SENS page 4-37

Use the numeric keypad to set the sensitivity (resolution) of the rotary control: select from fine (0.036°), medium (0.360°) or coarse (1.440°).

■ Set 0°Ref

FREQ: PHAS: REF page 4-36

Press ENTER to establish the current phase shift as the reference value. The indicated phase shift value is set to 0°.

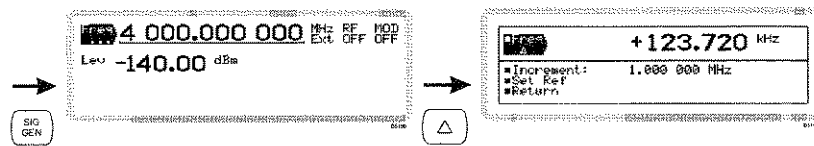

The △ key

Use this to vary any main function — carrier frequency, RF level, AM depth, FM/ΦM deviation or internal modulation source — from its keyed-in value. You can:

- Inspect the total shift from the last keyed-in value
- Change the step size when using the $\left(\frac{\times 10}{\downarrow}\right)$ and $\left(\frac{+10}{\uparrow}\right)$ keys
- Transfer the current value as the keyed-in value
- Return the setting to the last keyed-in value.

This example uses carrier frequency, but it could equally well be any of the above functions.

- 1 Touch **Freq** to select carrier frequency as the current function.
- 2 Press **△** to display the screen (Fig. 3-20).

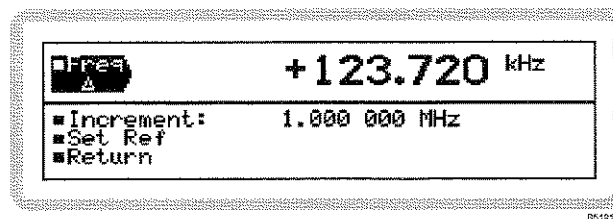

Fig. 3-20 Carrier shift and increment

■ Freq △

- 1 The screen displays the difference between the current carrier frequency and the keyed-in (reference) value. Change this using the control knob or $\left(\frac{\times 10}{\downarrow}\right)$ and $\left(\frac{+10}{\uparrow}\right)$ keys.
- 2 Make the current value the new reference by scrolling to **Set Ref** and pressing ENTER. This now becomes the reference value and the indicated shift value becomes zero.
- 3 Cancel any changes by scrolling to **Return** and pressing ENTER. The carrier frequency is restored to the last keyed-in (reference) value and the indicated shift is set to zero.

■ Increment

FREQ:STEP page 4-34

- 1 Scroll to **Increment** and use the numeric keyboard to set the size of step given by each press of the $\left(\frac{\times 10}{\downarrow}\right)$ and $\left(\frac{+10}{\uparrow}\right)$ keys. Press ENTER. These keys now step the frequency up or down by the increment you have set.
- 2 Press **SIG GEN** to return to the main screen.

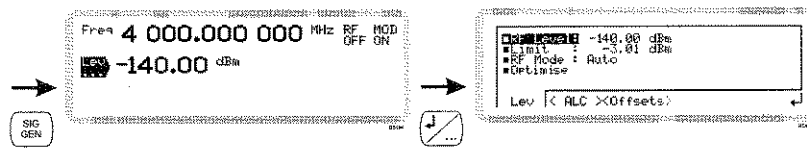

RF level menu — <Lev>

From this menu, you can:

- Set the RF level of the carrier
- Set a limit on the level of RF output *(not available when Option 001 is fitted)*
- Set the instrument's noise mode.

- 1 Touch **Lev** to select the RF level menu on the main screen (Fig. 3-17).
- 2 Press **↙** to view the sub-menus. *RF Level* is highlighted (Fig. 3-21).

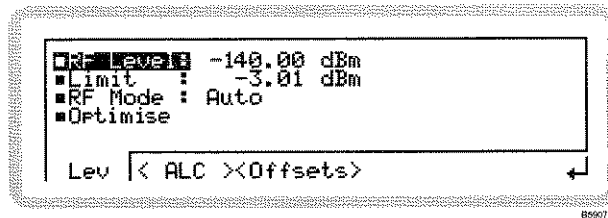

Fig. 3-21 RF level

■ RF Level

POW page 4-149

Enter an RF level, terminating with the appropriate units key. You can change the units: see page 3-141.

■ Limit

POW: LIM page 4-152

You can set your own maximum output power limit, which allows you to protect sensitive devices connected to the RF OUTPUT socket.

- 1 Set the level limit in the range -67 to $+73$ dBm. Terminate using the appropriate units key. You can change the units: see page 3-141.
The level limit you specify is for the device under test. The range allowed takes into account any offsets being applied (see page 3-30).
- 2 The setting is saved in non-volatile memory until changed again.

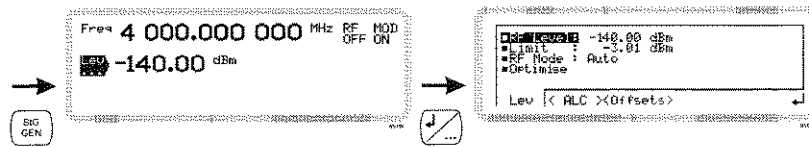

■ RF mode

POW: OPT page 4-153

A number of RF modes are available, with which you can optimize RF parameters such as maximum output power, noise floor and linearity of modulation. See the specification in Chapter 1 for full details of RF optimization modes.

Use the numeric keypad to specify the RF mode in order to optimize the carrier:

- 0 *Auto* RF optimization mode is automatically selected on the basis of requested output power. This can be overridden, as shown below.
- 1 *Power* Gives highest output power consistent with good noise floor figure and carrier harmonics. IQ/AM linearity is not specified.
- 2 *Noise* Gives as good a noise floor figure as the *Power* mode, still with reasonable output power. AM with IQ modulation performance is specified but crest factor/linearity is compromised compared with *ACP* mode.
- 3 *ACP* Gives optimal IQ linearity consistent with highest possible crest factor. Small compromise on noise floor/reduced output power.

RF optimization — an illustration (electronic attenuator)

Mode	Auto level (dBm)		Auto level (dBm)		Manual level (dBm)		Floor noise @ >5 MHz offset (dBc/Hz)	Linearity	Maximum crest factor (dB)
	CW/AM/FM/ΦM		IQ		Max	Min*			
	Max	Min	Max	Min					
Power	+16	+10.01	n/a	n/a	+16***	-128	<-142, typically -148	No requirement	3
Noise	+10	-134	+10	+0.01	+10***	-134	<-142, typically -148	Meets AM spec.	9
ACP	-134.01	-140	0	-140	0	-140	<-140	Meets 3GPP and TETRA ACPR spec.	15**

(for carrier frequencies between 10 and 3000 MHz; principle applies throughout frequency range)

- * Below these minimum levels the instrument shifts down to the next RF mode to give the requested output power.
- ** Higher crest factors (ratio of RMS to peak power) than 15 dB can be supported without clipping, provided that the external inputs are backed off appropriately from 0.5 V RMS.
- *** When IQ modulation is selected, maximum output is reduced by 6 dB below 100 MHz.

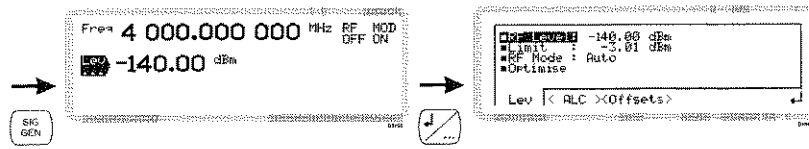

Instruments without attenuator (Option 001)

In *Auto* mode, the output range is from 0 to 22 dBm for carrier frequencies between 375 and 3000 MHz (principle applies throughout frequency range) and the RF optimization mode is chosen automatically

In other modes, performance is guaranteed within the level range of the mode. Above and below this range, the instrument still applies leveling but performance is not guaranteed.

Mode	Auto level (dBm)		Manual level (dBm)		Floor noise @ >5 MHz offset (dBc/Hz)	Linearity	Maximum crest factor (dB)
	Max	Min	Max	Min*			
Power	+22	+16.01	unspecified outside Power mode range		<-142, typically -148	No requirement	3
Noise	+16	+6.01	unspecified outside Noise mode range		<-142, typically -148	Meets AM spec.	9
ACP	+6	0	unspecified outside ACP mode range		<-140	Meets 3GPP and TETRA ACPR spec.	15**

Carrier/RF

■ **Optimise**

SOUR: POW: QRFN page 4-154

Touch the Start soft box to optimize level accuracy performance when operating in *Auto* or *ACP* RF mode (see above). This action is not necessary when in *Power* or *Noise* mode. When enabled on a fully warmed-up instrument, the optimization is valid for between 12 and 24 hours.

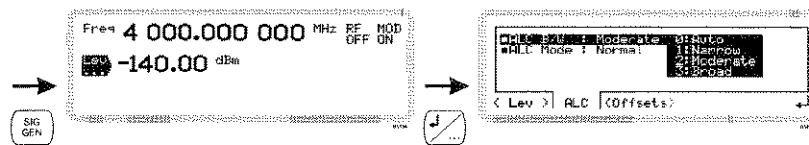

RF level menu — <ALC>

From this menu, you can specify how the RF output leveling is controlled.

From the RF level menu of Fig. 3-21, touch <ALC> or press **<TAB>** to display the ALC screen (Fig. 3-22).

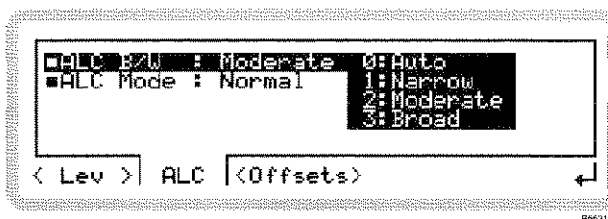
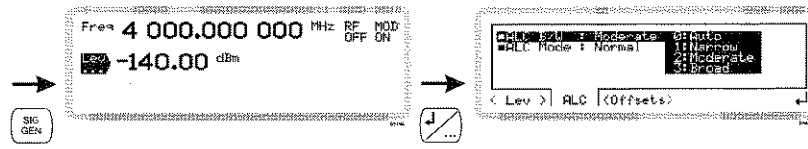

Fig. 3-22 ALC

■ ALC B/W

Use the numeric keypad to specify the automatic level control bandwidth:

- | | | |
|---|-----------------|---|
| 0 | <i>Auto</i> | ALC bandwidth is set automatically depending on the modulation type, source and characteristics. For internal IQ modulation, the instrument first reads the modulation identifier of the selected waveform. For CDMA type waveforms, it sets the ALC bandwidth to <i>Broad</i> . For non-CDMA type waveforms, it reads the bandwidth value in the header and sets the bandwidth to give the fastest settling time consistent with good signal quality (modulation accuracy and ACPR). |
| 1 | <i>Narrow</i> | Selects the slowest (largest) time constant. |
| 2 | <i>Moderate</i> | Selects the intermediate time constant. |
| 3 | <i>Broad</i> | Selects the fastest (smallest) time constant. |



■ **ALC Mode**

POW:ALC page 4-148

Use the numeric keypad to specify the automatic level control mode:

- 0 *Auto* The leveling mode is selected automatically, depending on modulation type. The instrument selects *Normal* mode for CW, FM, Φ M and IQ, and *AM* mode when AM modulation is needed.
- 1 *Normal* RF output power is controlled such that average power is leveled. IQ modulation can be applied as long as there is no slow variation of modulation with time (for example, QAM), where *Scaled* mode is the correct choice.
- 2 *AM* Carrier power is leveled independently of the level of the modulation sidebands; leveling to average voltage.
- 3 *Frozen* In this mode, the leveling loop is frozen and the RF output scales directly with IQ input power. The output power is 'frozen' at the gain setting determined previously from the ALC average power mode. The output power varies with temperature or applied modulation level.

This mode is useful where burst profile information is included in the IQ baseband signals.
- 4 *Scaled* Output power scales directly with IQ input power, but is leveled against temperature change. Useful where applied I and Q baseband signals contain slow time-varying information that must not be removed by the leveling loop (for example, QAM).

Note: For Frozen and Scaled modes, external IQ inputs must be 0.5 V RMS to produce the nominal output power.

Carrier/RF

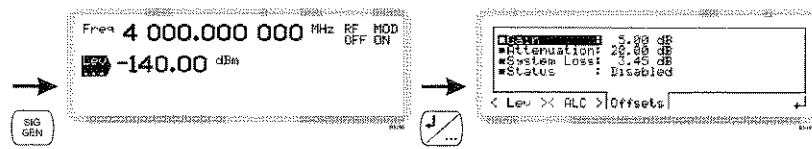

RF level menu — <Offsets>

From this menu, you can offset the RF output to compensate for the loss or gain resulting from an external device or cabling connected between the instrument and the device under test (DUT) (Fig. 3-23).

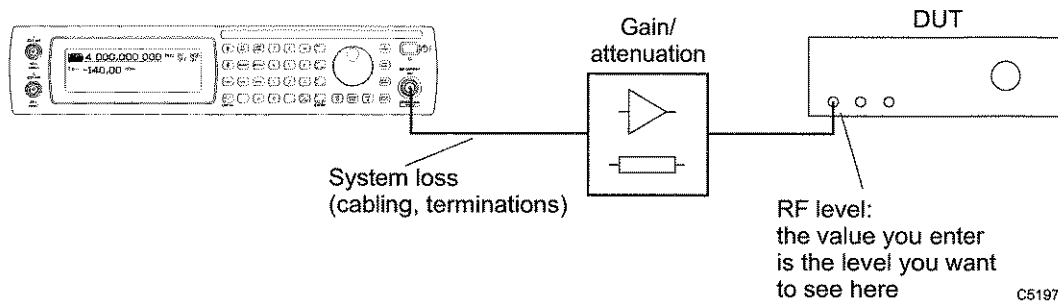

Fig. 3-23 RF level offsets

You set up the instrument so that:

- The gain or attenuation value is that of the external device and/or cabling.
- The RF level displayed is the level that you want at the DUT

The instrument automatically adjusts the signal level at its RF output to compensate for the external device and to ensure that the correct level is presented to the DUT.

RF level

- 1 From the RF level menu of Fig. 3-21, touch <Offsets> or press **<TAB>** to display the RF offset screen (Fig. 3-24).
- 2 Set gain, attenuation and system loss as required.
- 3 Finally, set the instrument's RF level (page 3-24) to the level that you require at the input of the DUT.

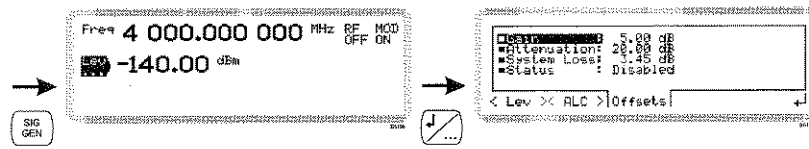

Fig. 3-24 RF level offset

Gain

POW: OFFS page 4-150

Enter the gain of the external device (a positive value only, or 0), terminating with $\frac{\text{Hz}}{\text{rad dB}}$.



■ **Attenuation**

POW:OFFS:ATT page 4-150

Enter the attenuation of the external device (a positive value only, or 0), terminating with $\frac{\text{Hz}}{\text{rad dB}}$.

■ **System Loss**

POW:OFFS:LOSS page 4-151

Enter a figure for power loss through the cabling (a positive value only, or 0), terminating with $\frac{\text{Hz}}{\text{rad dB}}$.

■ **Status**

POW:OFFS:STAT page 4-151

Use the numeric keypad to choose whether the offsets are enabled or disabled.

Offsets example

You can calculate the power present at the instrument's output from the following equation:

$$\text{Actual RF output power} = \text{displayed RF level} - \text{gain value} + \text{attenuation value} + \text{system loss value}$$

So for example, if:

- DUT requires -10 dBm at input,
- Attenuation consists of a 5 dB pad,
- Gain is 20 dB,
- System loss is 3 dB:

$$\begin{aligned} \text{Actual RF output power} &= -10 \text{ dBm} - 20 \text{ dB} + 5 \text{ dB} + 3 \text{ dB} \\ &= -22 \text{ dBm.} \end{aligned}$$

But note that you do not see this figure displayed! The instrument displays -10 dBm, the level required by the DUT.

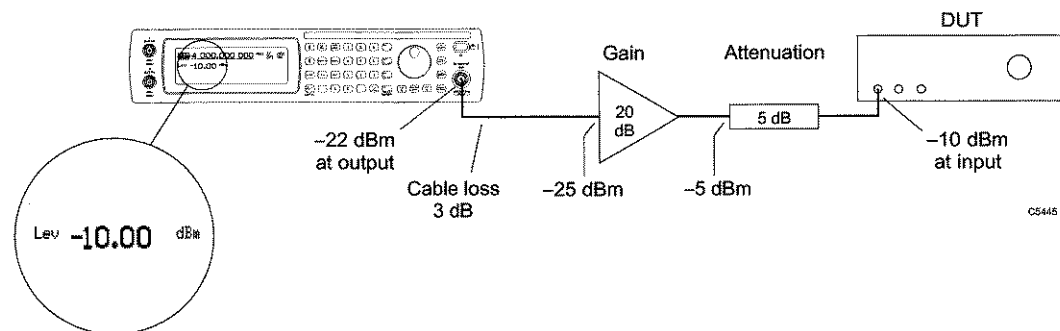



Fig. 3-25 Offsets example

Carrier/RF

Modulation summary

- You configure the instrument for IQ or analog modulation by pressing the  or  key to view the relevant modulation mode screen.
- You set up the type of modulation ('modulation mode') using the modulation mode screen. The main screen then displays function labels that reflect your choice of modulation.
- You set up the individual paths using the function labels.

Possible combinations of modulation

Table 3-1 shows the possible combinations of modulation. The types of modulation available depend on the options fitted to your instrument, so some of these modulation types may not be available.

Table 3-1 Combinations of modulation

	Int AM1	Int (AM1+AM2)	Ext AM1	Int FM1	Int (FM1+FM2)	Ext FM1	Int ϕ M1	Int (ϕ M1+ ϕ M2)	Ext ϕ M1	Internal IQ	External IQ	Differential IQ	Pulse	Int Burst	Ext Burst
Int AM1				√	√	√	√	√	√				√		
Int (AM1+AM2)				√		√	√		√				√		
Ext AM1				√	√	√	√	√	√				√		
Int FM1	√	√	√										√		
Int (FM1+FM2)	√		√										√		
Ext FM1	√	√	√										√		
Int ϕ M1	√	√	√										√		
Int (ϕ M1+ ϕ M2)	√		√										√		
Ext ϕ M1	√	√	√										√		
Internal IQ													√	√	
External IQ													√		√
Differential IQ															
Pulse	√	√	√	√	√	√	√	√	√	√	√				
Int Burst										√					
Ext Burst											√				

√ Allowed combination



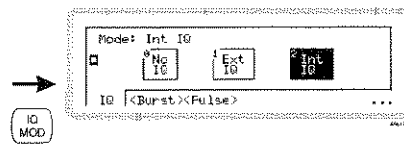

Internal IQ modulation — ARB option

Note: This section applies if you have an arbitrary waveform generator (ARB, Option 005) fitted to your instrument.

Maximum output power is reduced by 6 dB at frequencies below 100 MHz when using IQ modulation.

The ARB is the dual-channel arbitrary waveform IQ baseband source generator for the 3410 Series signal generators. It is used to generate signals from samples stored in non-volatile memory. Three digital signals (marker bits) may be stored with the samples, and these are processed to maintain their time relationship to the output waveforms.

Press to see the IQ modulation mode screen (Fig. 3-26). Use this to choose the type of IQ modulation to apply to the RF carrier. This screen's appearance may differ, depending on the options fitted to your instrument.

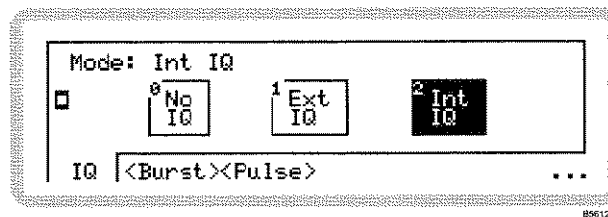

Fig. 3-26 Digital modulation mode

- 1 The screen shows the available configurations for the type of modulation selected on the soft tab at the bottom of the screen. The current modulation configuration is highlighted.
- 2 Touch any soft tab or scroll along the soft tabs using to see the configurations of the various forms of modulation — IQ, burst and pulse.
- 3 Touch the appropriate soft box (for example,) to choose the modulation required or switch modulation off by touching .

IQ: SOUR page 4-103

For example, in Fig. 3-26 the current selection is for internal IQ.

- 4 The three dots in the right-hand bottom corner of the screen show that you can press to see a relevant sub-menu that allows you to set up basic modulation parameters directly.
- 5 Press again to view the modulation mode screen.
- 6 Press to view the main screen, showing the current modulation mode.

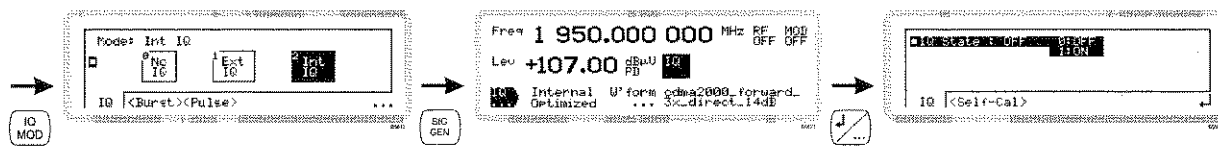

Internal IQ set-up (ARB operation)

You can configure internal IQ modulation directly from the *IQ* sub-menus on the main screen.

- 1 Configure the modulation mode for internal IQ modulation (page 3-35).
- 2 Press **SIG GEN** to show the main screen, and touch the **IQ** soft box to select the function. Touch **IQ** and press **<Self-Cal>** to view the internal IQ modulation menu (Fig. 3-27).

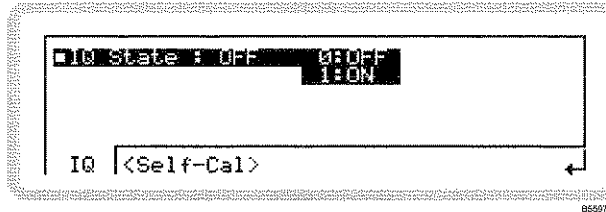

Fig. 3-27 Internal IQ

From this screen you can:

- Turn internal IQ modulation on or off
- Configure and perform a self-calibration on the I and Q signals.

Internal IQ menu — <IQ>

■ IQ State

IQ:STAT page 4-103

Use the numeric keypad to turn internal IQ modulation on or off:

- 0 *Off*
- 1 *On*

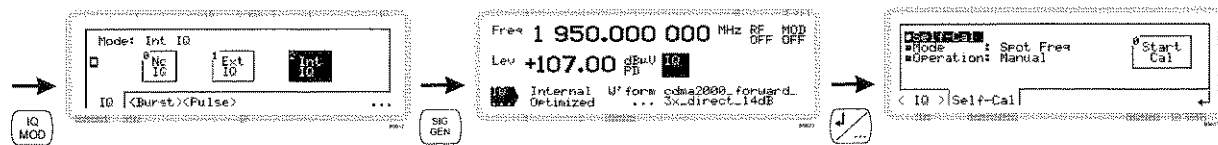

Internal IQ menu — <Self-Cal>

For optimum performance when in the IQ mode, run a self-calibration to make sure that the instrument meets its specification. When calibration is valid, the main screen (and a few others) show 'Optimized'. When calibration is invalid (for example, out of frequency range) 'Optimized' no longer appears; instead, a question mark appears in the IQ softbox: IQ?.

From this menu, you can:

- Start and stop self-calibration
- Define whether self-calibration is performed at a spot frequency or over a band
- Define manual or automatic self-calibration

From the internal IQ menu of Fig. 3-27, touch <Self-Cal> or press <TAB> to display the self-calibration screen (Fig. 3-28).

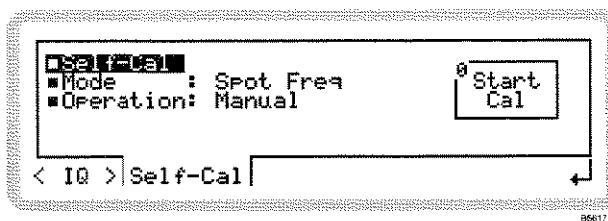

Fig. 3-28 Self-calibration

■ Self-Cal

Touch the Start Cal soft box, and the instrument performs the self-calibration operation chosen from the *Mode* menu. An *Abort Cal* soft box appears, allowing you to stop the self-calibration if you wish.

■ Mode

CAL: IQUS:MODE page 4:174

Use the numeric keypad to specify the internal IQ self-calibration mode:

- | | | |
|---|-------------------|--|
| 0 | <i>Spot Freq</i> | Performs a self-calibration at the current frequency. |
| 1 | <i>Freq Band</i> | A pop-up menu — ■ Freq Span — appears. Use the numeric keypad to define the frequency span ($\pm 10, 20, 40$ or 60 MHz with respect to the current carrier frequency) over which the IQ self-calibration is performed. |
| 2 | <i>Multi Band</i> | <Table> and <Edit> soft tabs appear, allowing you to define up to four frequency bands over which the IQ self-calibration is performed. Use the numeric keypad to enter start and stop frequencies for each band. |
| 3 | <i>Freq List</i> | <Table> and <Edit> soft tabs appear. Use the numeric keypad to define up to 500 list frequencies at which the IQ self-calibration is performed. |

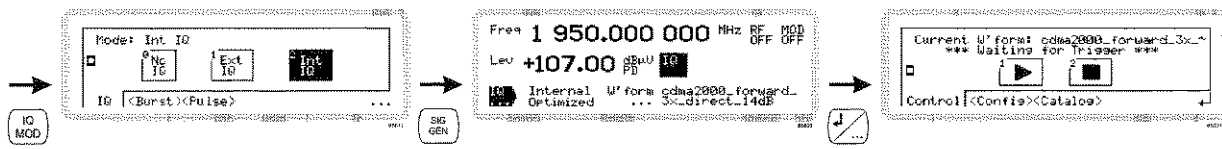

■ **Operation**

CAL: IQUS: OPER page 4-174
 CAL: IQUS: SPAN page 4-175

Use the numeric keypad to specify how internal IQ self-calibration starts:

- 0 *Manual* Spot frequency self-calibration starts when the Start Cal soft box is pressed.
- 1 *Auto* Self-calibration starts automatically whenever the carrier frequency changes.

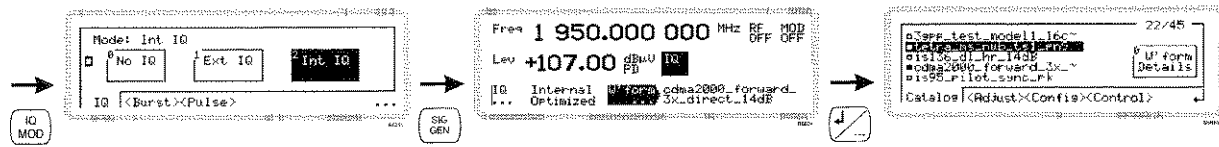

ARB waveform set-up

From this screen you can set up all aspects of the instrument's arbitrary waveform (ARB) generation.

- 1 Configure the modulation mode for internal IQ modulation (page 3-35).
- 2 Press **SIG GEN** to show the main screen, and touch the **IQ** soft box to select the function. Touch **Wform** and press **↓** to view the ARB catalog menu (Fig. 3-29).

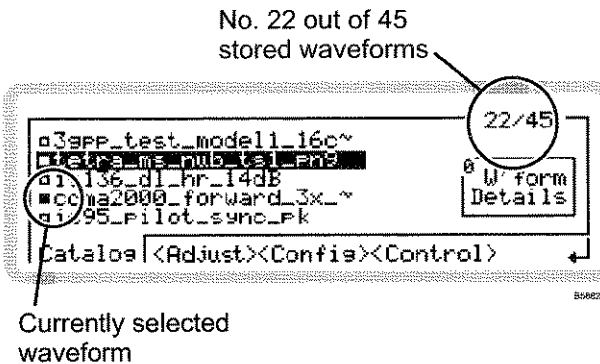

Fig. 3-29 ARB catalog

No waveform selected?

If you see a message saying that you have not selected a waveform, first touch the **<Catalog>** tab to display the waveforms that are available to select and play.





ARB menu — <Catalog>

IQ:ARB:WAV:CAT page 4-110

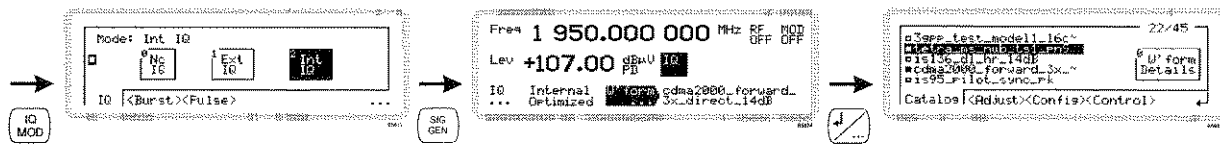

From this menu, you can:

- View a list of the stored waveforms
- Select a waveform to play
- Inspect the details of each waveform
- Erase a waveform



- 1 The currently selected waveform is shown by a solid box (■), other waveforms by a hollow box.
- 2 Numbers at the top right of the screen show the current position in the list, and the total number of waveforms stored.
- 3 Move up and down the list using the  and  navigation keys. If the name is too long to fit on this screen, it is shown ending with '~'.
Press ENTER to select the highlighted waveform.
- 4 Touch the  soft box to show details and the full name of the current waveform. Because it is a stored sample, you cannot change its parameters here.
- 5 Touch the  soft box to take you back to the ARB catalog screen.

Erasing a waveform file

- Select the waveform file that you want to erase.
- Press .
- If you want to cancel the request, press  again; otherwise:
- Confirm by pressing ENTER — the file is erased, and an updated catalog screen displayed.

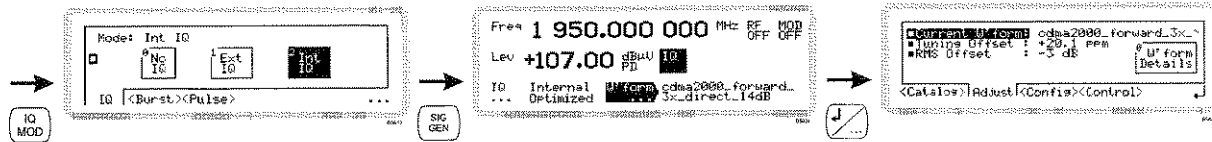

ARB menu — <Adjust>

From this menu, you can:

- View details of the currently selected waveform
- Define the tuning offset
- Define the RMS offset

From the ARB catalog menu of Fig. 3-29, touch <Adjust> or press **<TAB>** to display the ARB adjust screen (Fig. 3-30).

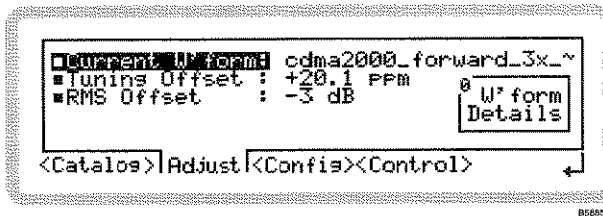

Fig. 3-30 ARB adjust

IQ mod. ARB

■ Current W'form

IQ:ARB:WAV:CAT page 4-111

- 1 The currently selected waveform is displayed.
- 2 Touch the **W'form Details** soft box to show details of the current waveform. Because it is a stored sample, you cannot change its parameters here.
- 3 Touch the **Config** soft box to take you back to the ARB configuration screen.

■ Tuning Offset

IQ:ARB:TOFF page 4-108

Use the numeric keypad (terminate with the ENTER key) to specify a small change to the stored sample rate.

■ RMS Offset

IQ:ARB:ROFF page 4-108

Use the numeric keypad (terminate with the ENTER key) to vary the RMS level of the signal from the ARB into the IQ modulator.

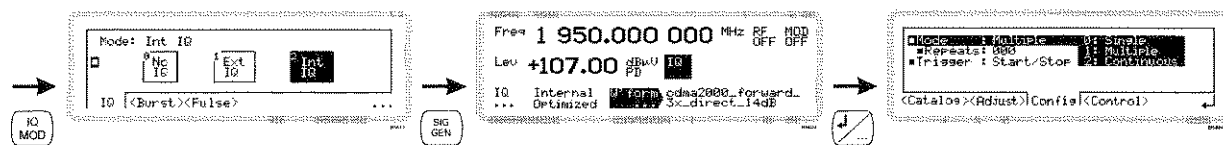

ARB menu — <Config>

From this menu, you can:

- Define whether the output is to be continuous, single-shot or repeated a set number of times.
- Define how the trigger controls the ARB waveform output.

From the ARB catalog menu of Fig. 3-29, touch <Config> or press <TAB> to display the ARB configuration screen (Fig. 3-31).



Fig. 3-31 ARB configuration

■ Mode

IQ:ARB:MODE page 4-106

Use the numeric keypad to specify the waveform play mode:

- | | | |
|---|-------------------|--|
| 0 | <i>Single</i> | The waveform outputs once and stops, ready to play again. |
| 1 | <i>Multiple</i> | The waveform outputs a set number of times. |
| 2 | <i>Continuous</i> | The waveform outputs from the beginning and then starts again when the end of the file is reached. |

■ Repeats

IQ:ARB:MULT:REP page 4-107

This menu entry appears only when multiple play mode is selected.

Use the numeric keypad to define the number of repeats of the waveform. The waveform outputs once, then repeats for the number of times defined.

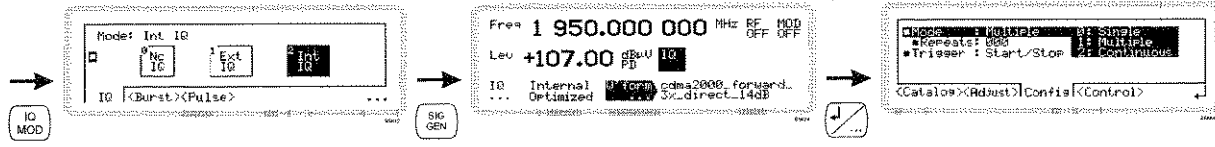

■ **Trigger**

IQ:ARB:TRIG page 4-109

Use the numeric keypad to specify the external trigger mode:

- | | Single mode | Continuous mode |
|---|---|---|
| <p>0 Immediate When you select it, the waveform plays once. Stop and start it using the ARB controls (page 3-44).</p> <p>1 Start The first trigger starts the waveform. At the end of the waveform the trigger latch resets, ready for the next input. During the output, trigger inputs are ignored. The trigger can either be manual () or from the external trigger input.</p> <p>2 Start/Stop The first trigger starts the waveform, the next trigger stops it. The trigger latch resets after each start/stop. The trigger can either be manual () or from the external trigger input.</p> <p>3 Gated The external trigger functions as a gate (high=ON) on the output signal.</p> | <p>When you select it, the waveform plays once. Stop and start it using the ARB controls (page 3-44).</p> <p>The first trigger starts the waveform running continuously. The instrument ignores any further trigger inputs. Stop generation of the waveform at any time by touching ; the trigger latch resets, ready for the next input. The trigger can either be manual () or from the external trigger input.</p> <p>The first trigger starts the waveform, the next trigger stops it. The trigger latch resets after each start/stop. The trigger can either be manual () or from the external trigger input.</p> | <p>When you select it, the waveform plays continuously. Stop and start it using the ARB controls (page 3-44).</p> <p>The first trigger starts the waveform running continuously. The instrument ignores any further trigger inputs. Stop generation of the waveform at any time by touching ; the trigger latch resets, ready for the next input. The trigger can either be manual () or from the external trigger input.</p> <p>The first trigger starts the waveform, the next trigger stops it. The trigger latch resets after each start/stop. The trigger can either be manual () or from the external trigger input.</p> |

Note: the ARB external trigger input is on contact 7 of the Auxiliary connector (Chapter 2).

Trigger Delay

IQ:ARB:TRIG:HOLD page 4-109

Sets a delay before the ARB starts to run, following a trigger event.

Restart

IQ:ARB:REST page 4-107

This menu entry appears only when the trigger mode is set to Start.

Use the numeric keypad to define whether a playing waveform is restarted by the trigger input.

- 0 Disabled** Waveform output is unaffected by the trigger input after the Start trigger.
- 1 Enabled** Waveform output is interrupted by the trigger input, restarting immediately at the beginning of the file.

IQ mod. ARB

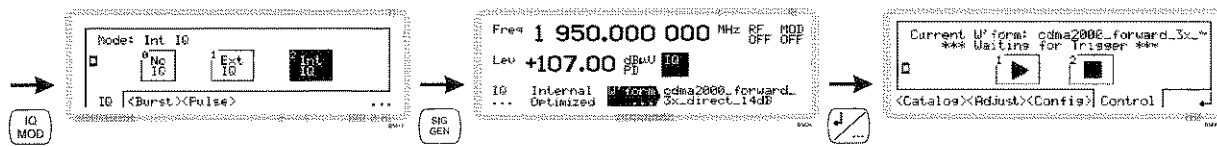

ARB menu — <Control>

From this menu, you can start and stop the output of the ARB generator by touching soft boxes on the screen.

The currently selected waveform is displayed, and messages on the screen shown the current status of the output: for example, *Waiting for Trigger*, *Generating Waveform*.

From the ARB catalog menu of Fig. 3-29, touch <Control> or press **<TAB>** to display the control screen (Fig. 3-32).

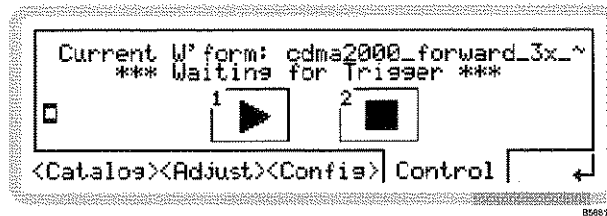

Fig. 3-32 ARB control



IQ:ARB:INIT page 4-106

Touch the *Play* soft box to start generating a waveform. If generation is set to *Continuous Mode* (page 3-42) the waveform plays indefinitely.



IQ:ARB:ABOR page 4-106

Stop the output at any time by touching this soft box. The ARB generator halts immediately.

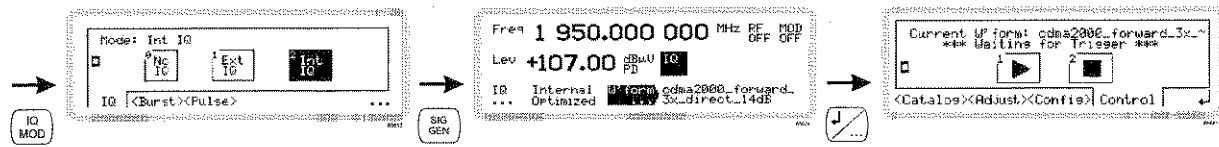

ARB waveform format

Information on the format of an ARB waveform, its header structure and marker bits, appears on page 3-164.

IQCreator®

IQCreator® is a software package that allows you to create and package an arbitrary waveform file that can be loaded onto a 3410 Series signal generator. It is also possible to package and download files that have been created using other tools. Arbitrary waveforms that can be created by **IQCreator®** cover a wide range of digital modulation schemes.

IQCreator® is supplied on the CD-ROM that accompanies your instrument, together with a 'getting started' manual (part number 46882/599) that tells you how to create, download and package waveforms to run on the ARB, and a user guide (part number 46882/627) that gives details of the different modulation schemes supported. **IQCreator®** and its associated documentation are also available to download from the Aeroflex website <http://www.aeroflex.com/iqcreator>.

IQ mod. ARB

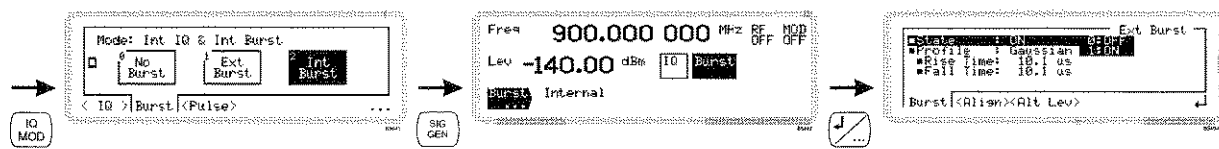

Internal (ARB) and external burst modulation set-up

Introduction to ARB/external burst modulation

From these menus, you can define the shape of a burst waveform (profile, rise and fall times) and its alignment (trigger interval, burst offset, change in duration). You can specify a reduced output level for a particular burst — the alternative level — if an electronic attenuator (Option 003) is fitted.

In Fig. 3-33, Marker 1 or an external trigger (active high) gates the RF signal on and off. Marker 2 or burst attenuation control, when applied to a particular burst, causes its level to be reduced by the amount specified in the *Burst Atten* field.

The auxiliary port (Chapter 2) outputs marker bits and accepts external burst controls — see page 3-52.

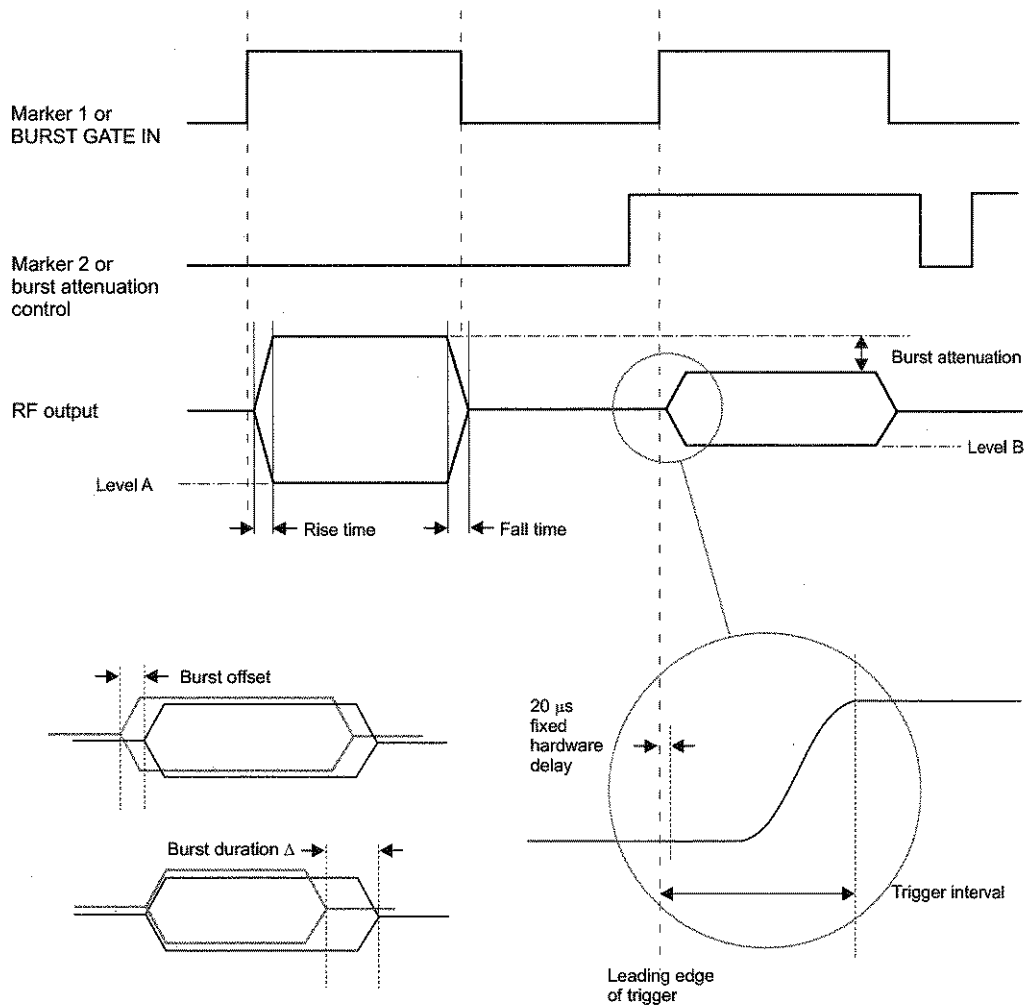

C5569

Fig. 3-33 Burst trigger timing

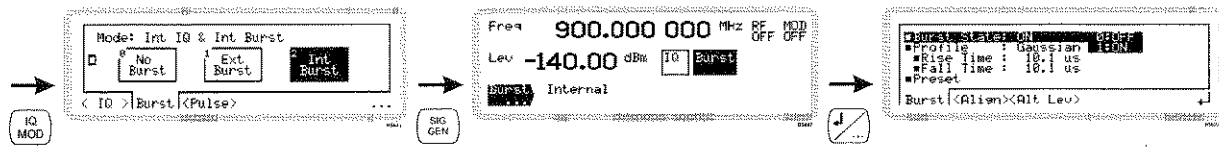

Note: for internal bursting to work correctly, the selected ARB waveform must contain burst markers. This is not necessary for external bursting, which operates independently of burst markers.

Burst set-up

- 1 Press **IQ MOD** to see the IQ modulation mode screen.
- 2 Touch **<Burst>**, and then the appropriate soft box to choose internal or external burst.
- 3 Press **SIG GEN** to show the main screen, and touch the **Burst** soft box to select the function. Touch **Burst** and press **↵** to view the burst profile screen (Fig. 3-34).



IQ mod. burst

Fig. 3-34 Burst modulation

Burst waveform — <Burst>

■ **Burst State**

BURS: STAT page 4-74

Use the numeric keypad to turn the burst source on or off.

■ **Profile**

Use the numeric keypad to specify the profile of the burst waveform:

- 0 *None* Unshaped waveform with very fast rise and fall times.
- 1 *Cosine* Waveform with a slower response, giving few sidebands for best ACP.
- 2 *Gaussian* Waveform with steeper rise and fall times, suitable for GSM testing.

■ **Rise Time**

BURS: EXT: RTIM page 4-66

BURS: INT: RTIM page 4-72

Use the numeric keypad to specify the rise time, in μ s, for the cosine or Gaussian burst profile, and terminate using the ENTER key. Rise time is limited by the trigger interval.

■ **Fall Time**

BURS: EXT: FTIM page 4-64

BURS: INT: FTIM page 4-70

Use the numeric keypad to specify the fall time, in μ s, for the cosine or Gaussian burst profile, and terminate using the ENTER key.

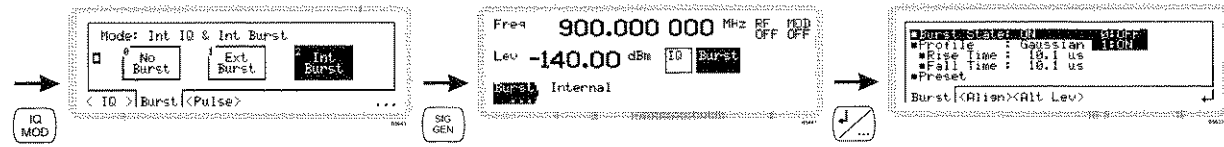

■ **Preset** (internal burst modulation only)

`IQ:ARB:WAV:BURS:PRES` page 4-109

Press ENTER to restore burst settings to the default values stored in the current waveform header.

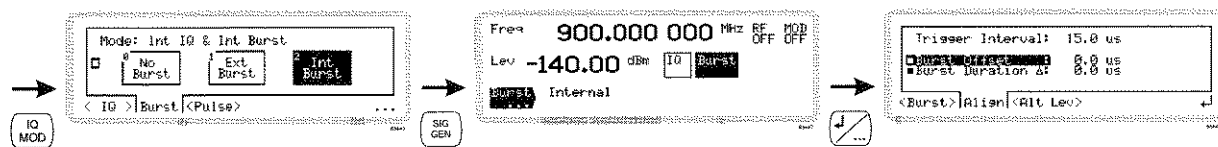

Burst waveform — <Align>

From this menu, you can vary the alignment of the burst with respect to the Marker 1 bit or external trigger input.

From the burst modulation menu of Fig. 3-34, touch <Align> or press **(TAB)** to display the burst alignment screen (Fig. 3-35).



Fig. 3-35 Burst alignment

Note: Burst parameters of an ARB waveform that has been generated by IQCreator®, including the trigger interval, are established by the file's header. You cannot alter the Trigger Interval from the front panel directly for these internally-generated waveforms. However, entering a positive or negative Burst Offset causes the trigger interval to change by the corresponding amount. The ability to control burst offset allows you to 'fine tune' parameters without needing to generate a new ARB waveform each time.

■ Trigger Interval

BURS: EXT: TINT page 4-66

BURS: INT: TINT page 4-71

Note: You can only adjust the trigger interval whilst in external IQ modulation mode.

Use the numeric keypad to specify the trigger interval for the burst, in μs , and terminate using the ENTER key. The trigger interval (see Fig. 3-33) can be used to make adjustments to the timing of the start of the burst with respect to the Marker 1 or external trigger input.

The trigger interval includes a fixed 20 μs delay that represents the combination of different delays within the instrument's hardware.

The trigger interval will vary as the burst offset (below) is changed. It is also affected by the waveform's rise time.

■ Burst Offset

BURS: EXT: OFFS page 4-65

BURS: INT: OFFS page 4-71

Use the numeric keypad to specify the offset for the burst, in μs , and terminate using the ENTER key. Burst offset (see Fig. 3-33) varies the position of the complete burst with respect to the Marker 1 or external trigger input.

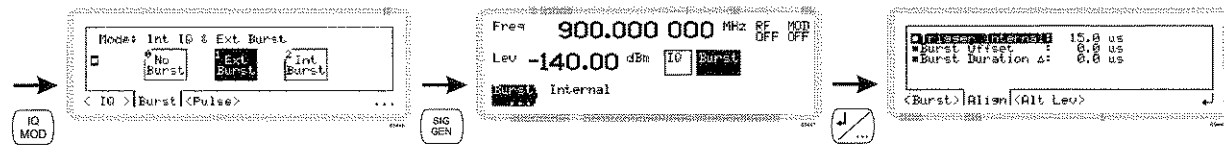

■ **Burst Duration Δ**

BURS:EXT:DDEL page 4-64

BURS:INT:DDEL page 4-70

Use the numeric keypad to specify the duration Δ for the burst, in μs , and terminate using the ENTER key. Burst duration Δ (see Fig. 3-33) varies the length of the burst.

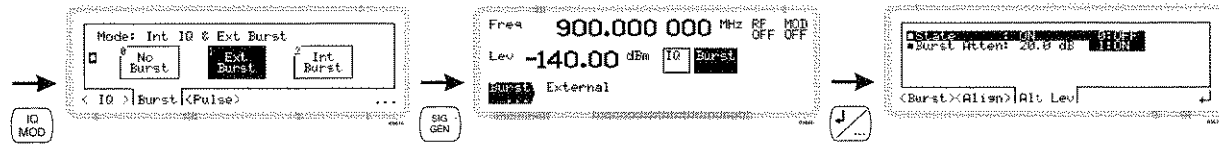

Burst waveform — <Alt Lev> (Option 003 electronic attenuator only)

From this menu, you can define the trigger source for burst attenuation, and its level.

From the burst modulation menu of Fig. 3-34, touch <Alt Lev> or press **[TAB]** to display the burst alternate level screen (Fig. 3-36).



Fig. 3-36 Burst alternate level

■ **State**

BURS:EXT:ALT:STAT page 4-63
BURS:INT:ALT:STAT page 4-67

Use the numeric keypad to specify whether alternative level bursting is on or off.

■ **Burst Atten** (Option 003 electronic attenuator only)

BURS:EXT:ALT:ATT page 4-63
BURS:INT:ALT:ATT page 4-67

Use the numeric keypad to specify the burst attenuation.

The value you enter represents the difference in level between the burst waveform and the nominal output.

IQ mod. burst

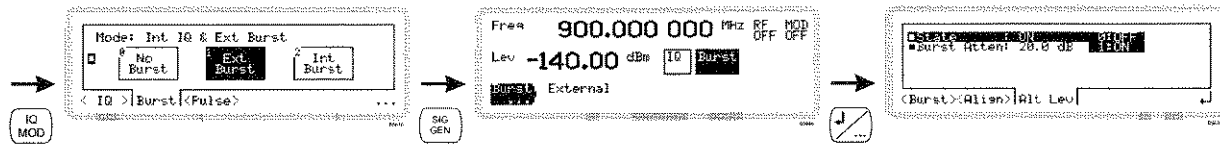

External burst interfaces

When external burst is selected, the connector allocation is as follows:

IQ modulation	Burst control interface
External analog	Auxiliary D-type

Bursting is controlled by logic levels applied to the auxiliary port connector (A/B burst attenuation control and burst gate in).

Burst gate	A/B burst attenuation	Result
Contact 11	Contact 5	
1	0	Levels the carrier using the A setting (nominal output power)
1	1	Levels the carrier using the B setting (x dB below nominal output power)
0	X	Suppresses the RF output

Do not change levels while Burst is enabled (logic 1) as the transition between levels is uncontrolled.

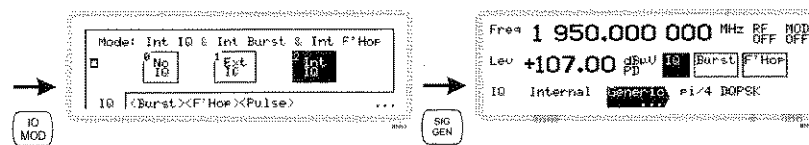

Internal IQ modulation — real-time baseband option

Note: This section applies only if you have real-time baseband (RTBB, Option 008) fitted to your instrument.

Maximum output power is reduced by 6 dB at frequencies below 100 MHz when using IQ modulation.

The real-time baseband option (RTBB) generates baseband signals (I and Q) that modulate an RF source in real time. The baseband board generates or inputs a set of modulation symbols; modulates them with the chosen scheme; filters them using an appropriate channel filter; and then converts the digital stream to analog I and Q. The symbol data can originate from a variety of sources: internal PRBS generator; internal pattern generator; internal memory storage of symbols from an external source; real-time symbols from an external source via the LVDS interface.

Press to see the IQ modulation mode screen (Fig. 3-37). Use this to choose the type of IQ modulation to apply to the RF carrier. This screen's appearance may differ, depending on the options fitted to your instrument.

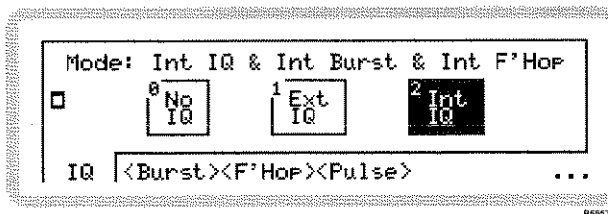
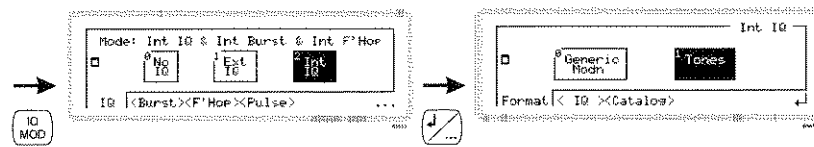

Fig. 3-37 Available IQ modulation configurations

- 1 The screen shows the available configurations for the type of modulation selected on the soft tab at the bottom of the screen. The current modulation configuration is highlighted.
- 2 Touch any soft tab or scroll along the soft tabs using to see the configurations of the various forms of modulation — IQ, burst, frequency hopping and pulse.
- 3 Touch the appropriate soft box to choose the modulation required
or
switch modulation off by touching .



For example, in Fig. 3-37 the current selection is for internal IQ modulation.

- 4 The three dots in the right-hand bottom corner of the screen show that you can press to see a relevant sub-menu that allows you to set up basic modulation parameters directly.
- 5 Press again to view the modulation mode screen.
- 6 Press to view the main screen, showing the current modulation mode.



Configure internal IQ — format

You need to configure the format of internal IQ modulation before selecting other submenus. The formats available depend on the software currently installed in your instrument.

- 1 Configure the modulation mode for internal IQ modulation (page 3-53).
- 2 Press  and  to view the internal IQ format menu (Fig. 3-38).

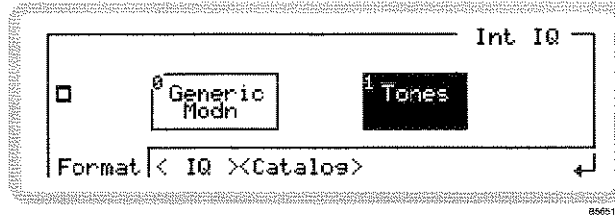

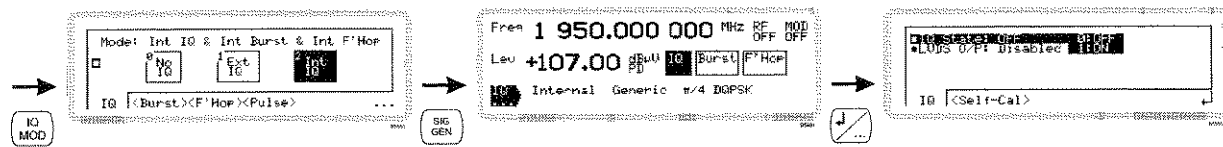

Fig. 3-38 Internal IQ format

- 3 Touch the appropriate soft box to select the internal modulation format.

IQ: DM: FORM: page 4-116

- 4 Press  to show the main screen.
- 5 Continue with internal IQ set-up on the following pages.



Internal IQ set-up

You can configure internal IQ modulation directly from the *IQ* sub-menus on the main screen.

- 1 Configure the modulation mode for internal IQ modulation (page 3-53).
- 2 Press **SIG GEN** to show the main screen, and touch the **IQ** soft box to select the function. Touch **IQ** and press **↙** to view the internal IQ modulation menu (Fig. 3-39).



Fig. 3-39 Internal IQ, real-time baseband

From this screen you can:

- Turn internal IQ modulation on or off
- Enable or disable the LVDS connector on the rear panel
- Configure and perform a self-calibration on the I and Q signals.

Internal IQ menu — <IQ>

■ IQ State

OUT: MOD: IQ page 4-22

Use the numeric keypad to turn internal IQ modulation on or off:

- 0 Off
- 1 On

■ LVDS O/P

OUTP: LVDS page 4-20

Use the numeric keypad to turn the LVDS connector's output on or off. IQ data, marker bits and frequency hopping bits are output when the output is enabled.

- 0 Disabled
- 1 Enabled

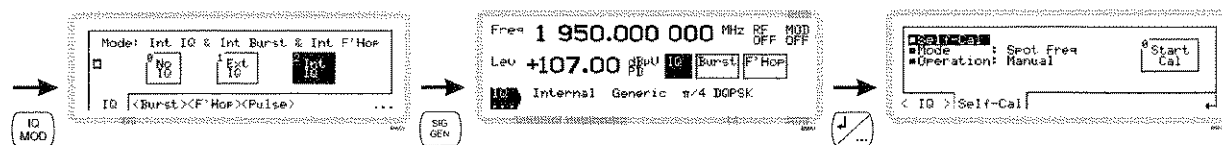

Internal IQ menu — <Self-Cal>

■ Self-Cal

For optimum performance when in the IQ mode, run a self-calibration to make sure that the instrument meets its specification. When calibration is valid, the main screen (and a few others) shows 'Optimized'. When calibration is invalid (for example, out of frequency range) 'Optimized' no longer appears; instead, a question mark appears in the IQ softbox: **IQ?**.

Touch the **Start Cal** soft box, and the instrument performs the IQ self-calibration operation chosen below, in order to re-align the IQ modulator. An *Abort Cal* soft box appears, allowing you to stop the self-calibration if you wish.

■ Mode

CAL: IQUS:MODE page 4-174

Use the numeric keypad to specify the internal IQ self-calibration mode:

- | | | |
|---|-------------------|--|
| 0 | <i>Spot Freq</i> | Performs an IQ self-calibration at the current frequency. |
| 1 | <i>Freq Band</i> | A pop-up menu — ■ Freq Span — appears. Use the numeric keypad to define the frequency span ($\pm 10, 20, 40$ or 60 MHz with respect to the current carrier frequency) over which the IQ self-calibration is performed. |
| 2 | <i>Multi Band</i> | <Table> and <Edit> soft tabs appear, allowing you to define up to four frequency bands over which the IQ self-calibration is performed. Use the numeric keypad to enter start and stop frequencies for each band. |
| 3 | <i>Freq List</i> | <Table> and <Edit> soft tabs appear. Use the numeric keypad to define up to 500 list frequencies at which the IQ self-calibration is performed. |

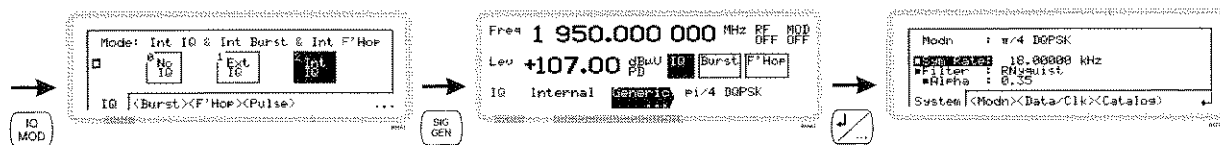

Generic modulation set-up

From this screen you can set up all aspects of the instrument's generic modulation.

- 1 Configure the modulation mode for internal IQ modulation (page 3-54).
- 2 Press **SIG GEN** to show the main screen, and touch the **IQ** soft box to select the function. Touch **Generic** and press **↓** to view the Generic modulation menu (Fig. 3-40).

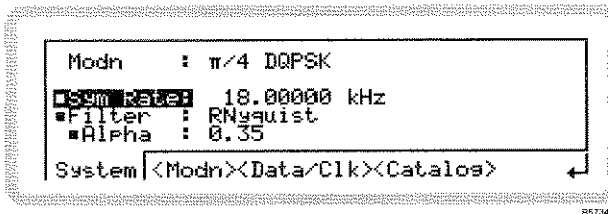

Fig. 3-40 Generic modulation

IQ mod. RTBB

Generic mod — <System>

From this menu, you can:

- Select the filter type and set its response
- Set the symbol rate
- Set the deviation (FSK only).

The currently selected modulation type and data source are displayed.

■ Sym Rate

IQ:DM:GEN:SRAT page 4-132

Use the numeric keypad to specify the symbol rate. Enter up to nine characters (including decimal point) and terminate with **kHz** or **ms mV**.

■ Filter

IQ:DM:GEN:FILT page 4-128

A pop up selection of filter types (or none) appears. Use the numeric keypad to specify the filtering to be applied to the generic IQ data entering the instrument.

If a filter parameter is displayed (for example **Alpha**), you can select it (use **↓**) and change its value.

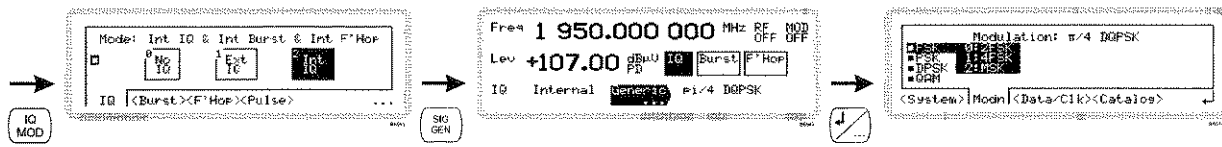

Generic Mod menu — <Modn>

From this menu, you can select the type of modulation to be applied.

From the generic modulation screen of Fig. 3-40, touch <Modn> or press **[TAB]** to display the modulation selection screen (Fig. 3-41).



Fig. 3-41 Modulation type selection

- FSK
- PSK
- DPSK
- QAM

Select the modulation scheme using the **[↑]** and **[↓]** keys. Use the numeric keypad to select the variant within the scheme.

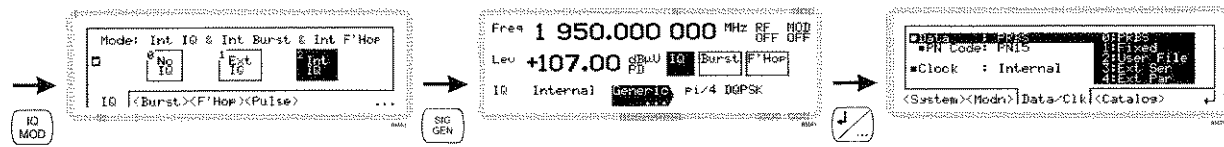

Generic Mod menu — <Data/Clk>

From this menu, you can:

- Select a data source, and configure that source
- Set the type of bit encoding
- Select between an internal and external clock. You can phase-align the internal clock with an external one — see *CLK-OUT sync* in Chapter 2.

From the generic modulation screen of Fig. 3-40, touch <Data/Clk> or press **<TAB>** to display the data and clock source screen (Fig. 3-42).

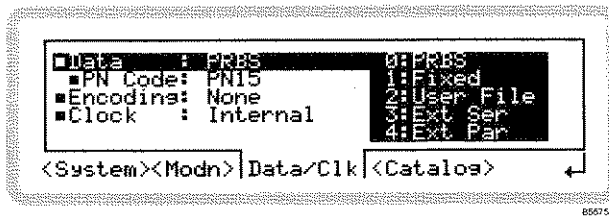

Fig. 3-42 Data and clock source selection

IQ mod. RTBB

■ Data

IQ:DM:GEM:DATA page 4-125

Use the numeric keypad to specify the data source:

- 0** *PRBS* Selects a pseudo-random binary sequence. Use the numeric keypad to select from the **■PN Code** list.
- 1** *Fixed* Selects a fixed-bit pattern. Use the numeric keypad to select from the **■Pattern** list.
- 2** *User File* Selects a user data file. Provides a choice of files when you touch the **Data Files** soft box. Move up and down the list using the **↓** and **↑** navigation keys, and press ENTER to select the highlighted configuration file.
- 3** *Ext Ser* Selects an external serial bit stream.
- 4** *Ext Par* Selects an external parallel bit stream.

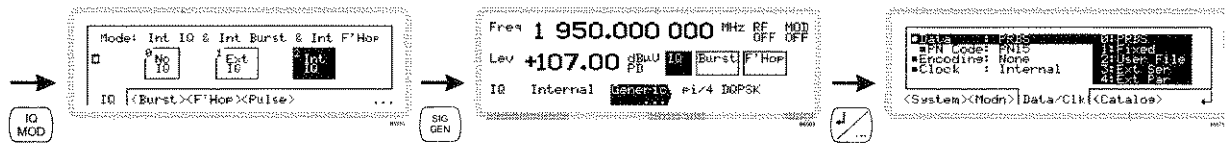

■ Encoding

IQ:DM:GEN:ENC page 4-125

Use the numeric keypad to specify the encoding:

- 0 *None*
- 1 *Diff*
- 2 *GSM Diff*
- 3 *Inverted*

■ Clock

Use the numeric keypad to specify **internal** or **external** clock source.

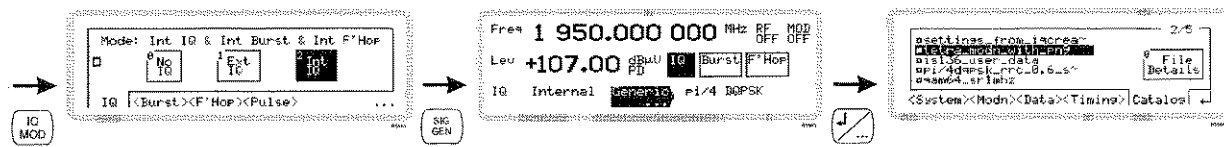

Generic Mod menu — <Catalog>

Using **IQCreator**®, you can create generic modulation configuration files and download them to the instrument.

From this menu, you can:

- View a list of the stored modulation configuration files
- Inspect the details of each file
- Erase a file.

Touch <Catalog> or press **<TAB>** as required to display the catalog screen (Fig. 3-43).

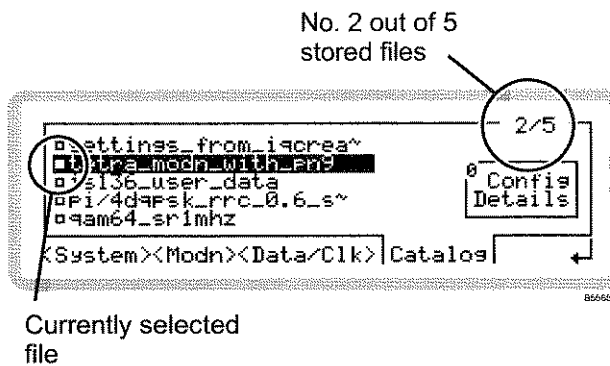

Fig. 3-43 Digital modulation catalog

- 1 The currently selected configuration file is shown by a solid box (■), other files by a hollow box.
- 2 Numbers at the top right of the screen show the current position in the list, and the total number of files stored.
- 3 Move up and down the list using the **↓** and **↑** navigation keys. Use the **↕** and **↕** keys to move a page at a time. If the name is too long to fit on this screen, it is shown ending with '~'.
Press ENTER to select the highlighted configuration file.
- 4 Touch the **Config Details** soft box to show details and the full name of the current file.
- 5 Touch the **Catalog** soft box to take you back to the generic modulation catalog screen.

Erasing a configuration file

- Select the configuration file that you want to erase.
- Press **↵**.
- If you want to cancel the request, press **↵** again; otherwise:
- Confirm by pressing ENTER — the file is erased, and an updated catalog screen displayed.

IQ mod, RTBB

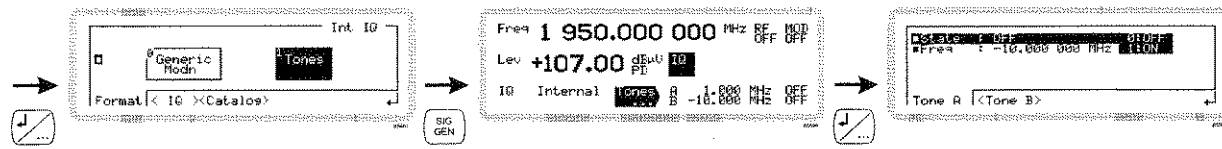

Tones set-up

From this screen you can:

- Turn tones on or off
- Set tone frequencies
- Set the level of Tone B with respect to Tone A.

- 1 Configure the modulation mode for tones (page 3-54). IQ: DM: FORM page 4-116
- 2 Press **SIG GEN** to show the main screen, and touch the **IQ** soft box to select the function. Touch **Tones** and press **↵** to view the Tones menu (Fig. 3-44).

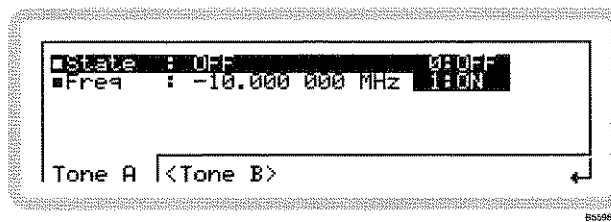

Fig. 3-44 Tones modulation

Tones — <Tone A>

■ State

IQ: DM: TON: A: STAT page 4-120

Use the numeric keypad to turn Tone A on or off.

■ Freq

IQ: DM: TON: A: FREQ page 4-120

Use the numeric keypad to specify the tone frequency and terminate with **[KHz]** or **[MHz]**. Negative frequency values (for example, -5 MHz) are allowed.

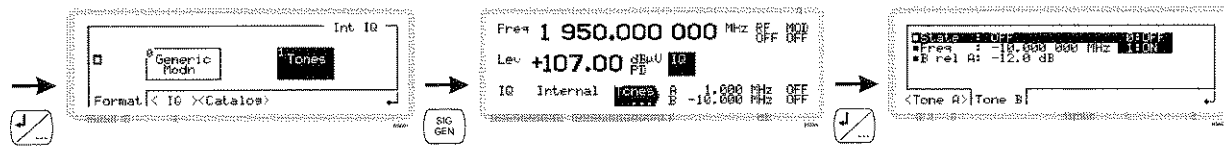

Tones — <Tone B>

■ **State**

IQ:DM:TON:B:STAT page 4-122

Use the numeric keypad to turn Tone B on or off.

■ **Freq**

IQ:DM:TON:B:FREQ page 4-121

Use the numeric keypad to specify the tone frequency and terminate with $\frac{\text{kHz}}{\% \mu\text{V}}$ or $\frac{\text{MHz}}{\text{ms mV}}$. Negative frequency values (for example, -5 MHz) are allowed.

■ **B rel A**

IQ:DM:TON:B:LEV page 4-121

Use the numeric keypad to specify the level of Tone B relative to Tone A, and terminate with $\frac{\text{kHz}}{\% \mu\text{V}}$ or $\frac{\text{MHz}}{\text{ms mV}}$.

Tone B can be set ± 60 dB relative to Tone A.

IQ mod. RTTB

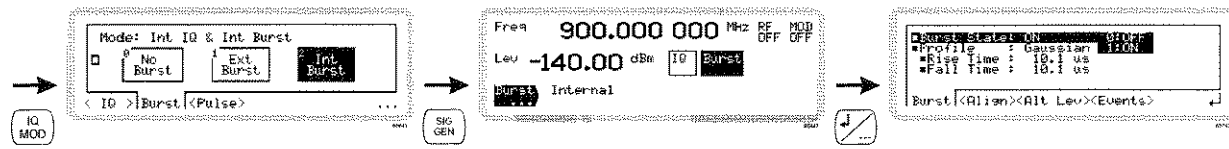

Internal (RTBB) and external burst modulation set-up

Introduction to RTBB/external burst modulation

From these menus, you can define the shape of a burst waveform (profile, rise and fall times) and its alignment (trigger interval, burst offset, change in duration). You can specify a reduced output level for a particular burst — the alternative level — if an electronic attenuator (option 003) is fitted.

In Fig. 3-45, marker 1 or an external trigger (active high) gates the RF signal on and off. Marker 2 or burst attenuation control, when applied to a particular burst, causes its level to be reduced by the amount specified in the *Burst Atten* field.

The auxiliary port and LVDS connectors (Chapter 2) output marker bits and accept external burst controls — see page 3-71.

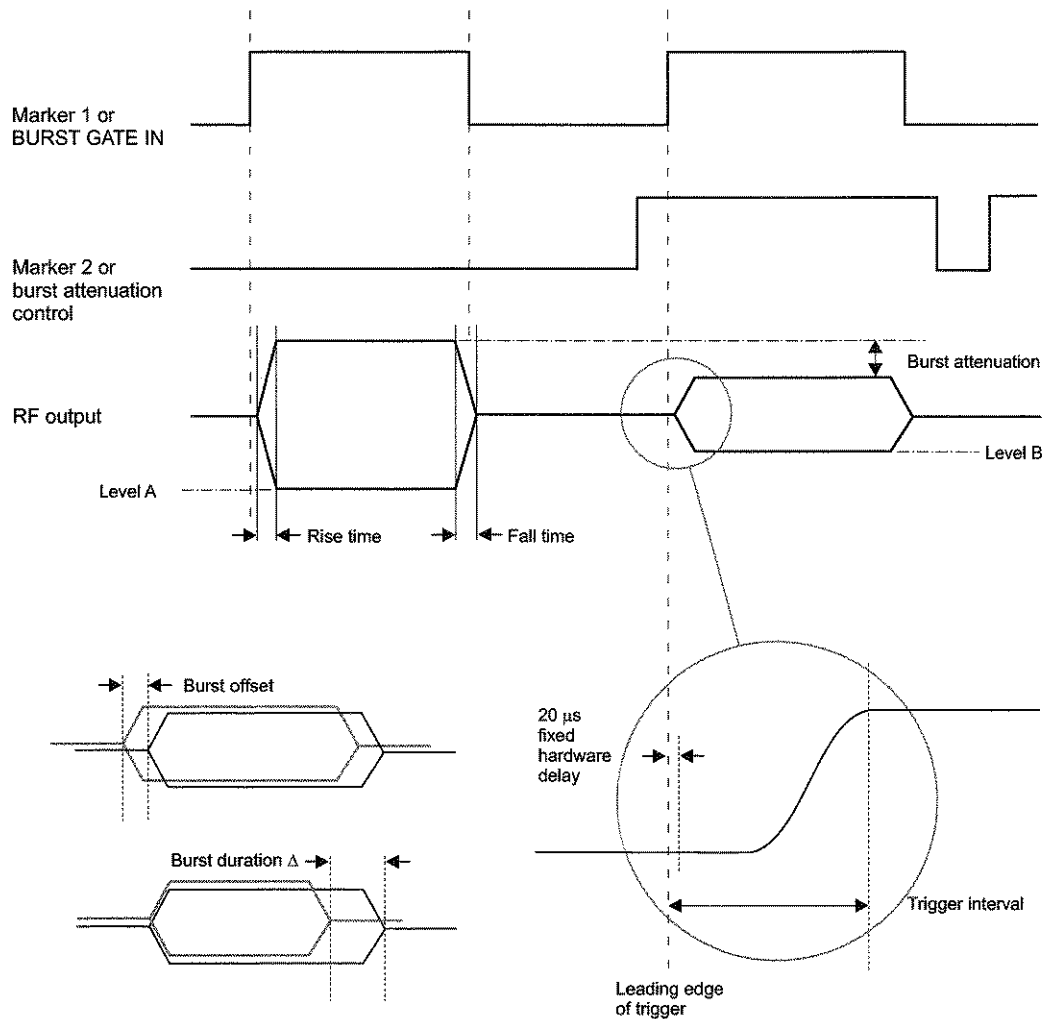

C5569

Fig. 3-45 Burst trigger timing

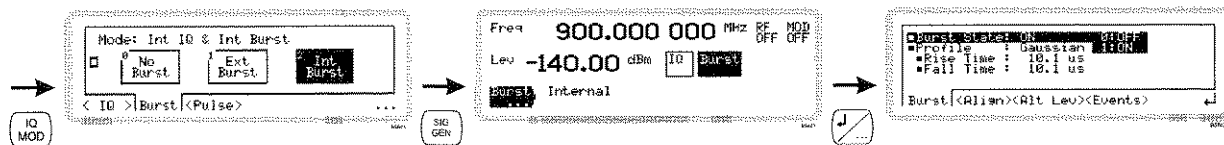

Note: you will see no burst output until you have set up some burst events (markers) — see page 3-69.

Burst set-up

- 1 Press **IQ MOD** to see the IQ modulation mode screen.
- 2 Touch **<Burst>**, and then the appropriate soft box to choose internal or external burst.
- 3 Press **SIG GEN** to show the main screen, and touch the **Burst** soft box to select the function. Touch **Burst** and press **↵** to view the burst profile screen (Fig. 3-46).



Fig. 3-46 Burst modulation

IQ mod burst

Burst waveform — <Burst>

■ **Burst State**

BURS: STAT page 4-74

Use the numeric keypad to turn the burst source on or off.

■ **Profile**

Use the numeric keypad to specify the profile of the burst waveform:

- 0 *None* Unshaped waveform with very fast rise and fall times.
- 1 *Cosine* Waveform with a slower response, giving few sidebands for best ACP.
- 2 *Gaussian* Waveform with steeper rise and fall times, suitable for GSM testing.

■ **Rise Time**

BURS: EXT: RTIM page 4-66

BURS: INT: RTIM page 4-72

Use the numeric keypad to specify the rise time, in μ s, for the cosine or Gaussian burst profile, and terminate using the ENTER key. Rise time is limited by the trigger interval.

■ **Fall Time**

BURS: EXT: FTIM page 4-64

BURS: INT: FTIM page 4-70

Use the numeric keypad to specify the fall time, in μ s, for the cosine or Gaussian burst profile, and terminate using the ENTER key.

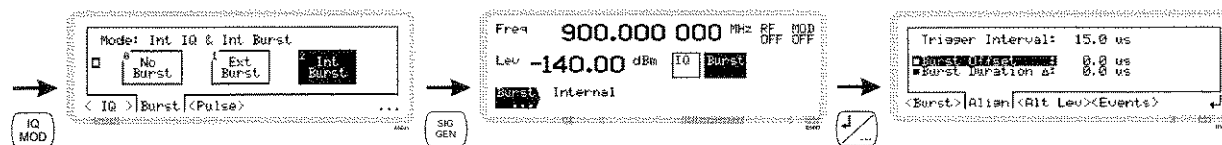

Burst waveform — <Align>

From this menu, you can vary the alignment of the burst with respect to the marker 1 bit or external trigger input.

From the burst modulation menu of Fig. 3-46, touch <Align> or press **<TAB>** to display the burst alignment screen (Fig. 3-47).



Fig. 3-47 Burst alignment

Note: For external bursting, you have full control over burst parameters within the limits of the instrument's capabilities. The trigger interval can be set from 26 μs to 1520 μs (26 μs is the minimum because of the 20 μs hardware latency plus the 6 μs minimum rise time). So, for example, if you set a trigger interval of 100 μs , and then you set a burst offset of -20 μs , the trigger interval changes to 80 μs . If you change the burst offset to -90 μs , it will limit at -74 μs to account for the 26 μs latency and will display the appropriate error message. If the rise time is changed from the default minimum 6 μs , this must also be taken into account. If you were to set a burst offset of 20 μs , the trigger interval changes to 120 μs . Changing or re-entering the trigger interval will reset the burst offset to 0.

■ Trigger Interval

BURS:EXT:TINT page 4-66

BURS:INT:TINT page 4-71

Note: You can only adjust the trigger interval whilst in external IQ modulation mode.

Use the numeric keypad to specify the trigger interval for the burst, in μs , and terminate using the ENTER key. The trigger interval (see Fig. 3-45) can be used to make small adjustments to the timing of the start of the burst with respect to the marker 1 or external trigger input.

The trigger interval includes a fixed 20 μs delay that represents the combination of different delays within the instrument's hardware.

The trigger interval will vary as the burst offset (below) is changed. It is also affected by the waveform's rise time.

■ Burst Offset

BURS:EXT:OFFS page 4-65

BURS:INT:OFFS page 4-71

Use the numeric keypad to specify the offset for the burst, in μs , and terminate using the ENTER key. Burst offset (see Fig. 3-45) varies the position of the complete burst with respect to the marker 1 or external trigger input.

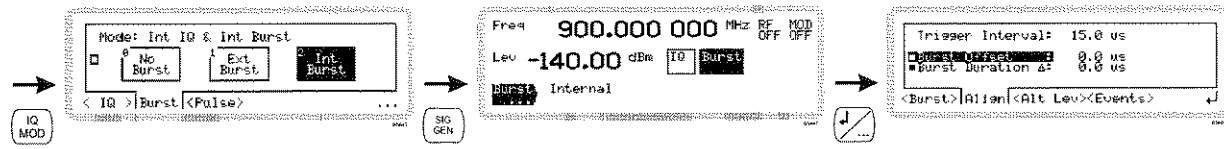

■ **Burst Duration Δ**

BURS:EXT:DDEL page 4-64
BURS:INT:DDEL page 4-70

Use the numeric keypad to specify the duration Δ for the burst, in μs , and terminate using the ENTER key. Burst duration Δ (see Fig. 3-45) varies the length of the burst.

IQ mod, burst

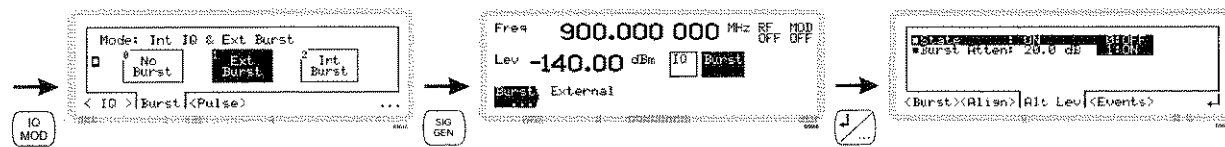

Burst waveform — <Alt Lev> (Option 003 electronic attenuator only)

From this menu, you can turn burst attenuation on and off, and set its level.

From the burst modulation menu of Fig. 3-46, touch <Alt Lev> or press **<TAB>** to display the burst alternate level screen (Fig. 3-48).

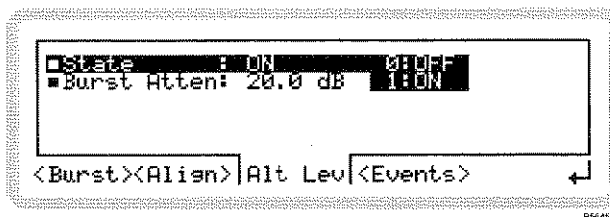

Fig. 3-48 Burst alternate level

■ **State**

BURS:EXT:ALT:STAT page 4-63
BURS:INT:ALT:STAT page 4-67

Use the numeric keypad to specify whether alternative level bursting is on or off.

■ **Burst Atten** (Option 003 electronic attenuator only)

BURS:EXT:ALT:ATT page 4-63
BURS:INT:ALT:ATT page 4-67

Use the numeric keypad to specify the burst attenuation.

The value you enter represents the difference in level between the burst waveform and the nominal output.

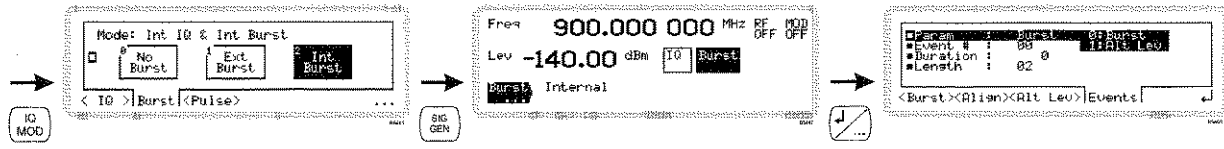

Burst waveform — <Events> (internal burst only)

From this menu, you can define the event parameter, the event number, duration and length to create the markers. Note that you need to set up the markers before bursting is possible.

From the burst modulation menu of Fig. 3-46, touch <Events> or press **[TAB]** to display the burst event screen (Fig. 3-49).

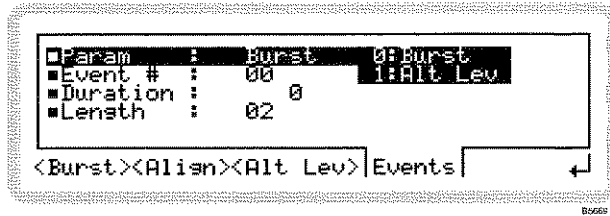

Fig. 3-49 Burst event

IQ mod, RTTB

■ **Param**

Use the numeric keypad to specify Burst or Alt Level event set-up.

■ **Event #**

BURS:INT:TRAN:LIST page 4-73

Use the numeric keypad to specify the event (transition point) number. Fig. 3-50 shows an example of this.

■ **Duration**

BURS:INT:TRAN:LIST page 4-73

Use the numeric keypad to specify the duration (offset) of the specified event. Fig. 3-50 shows an example of this.

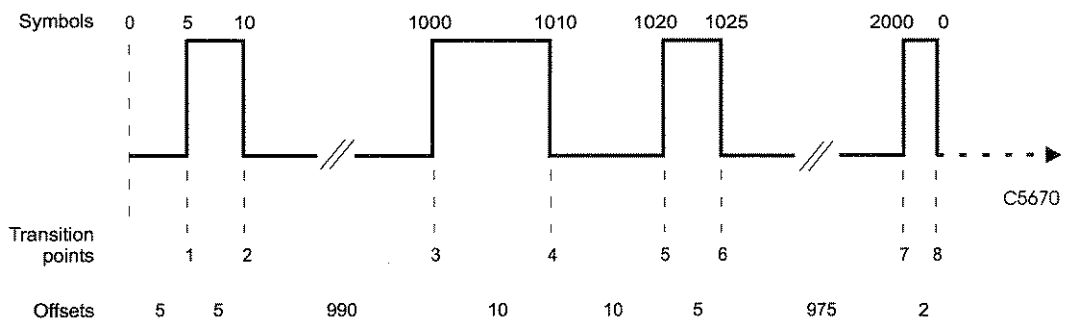
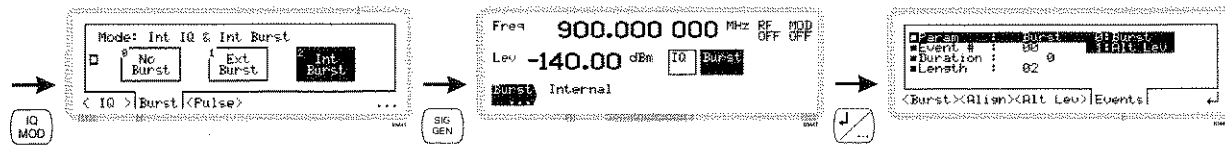

Fig. 3-50 Transition points (example)



Length

BURS:INT:TRAN:REP page 4-73

Use the numeric keypad to specify the repeat length of the burst marker. This is the transition number from which the burst pattern repeats. Fig. 3-51 shows an example of this.

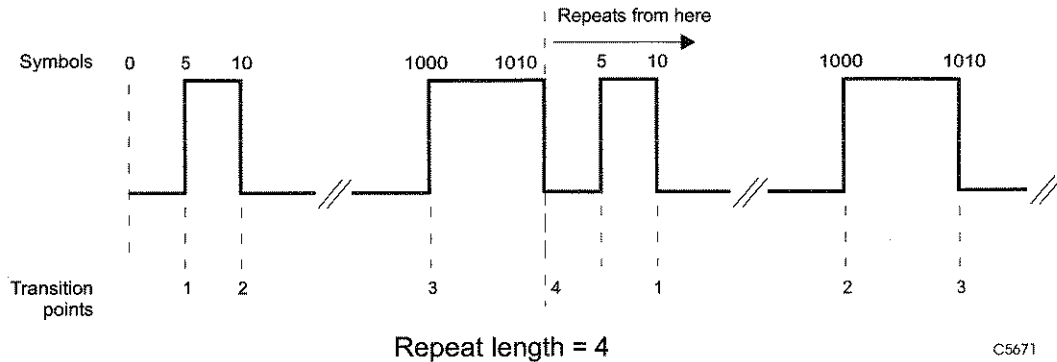
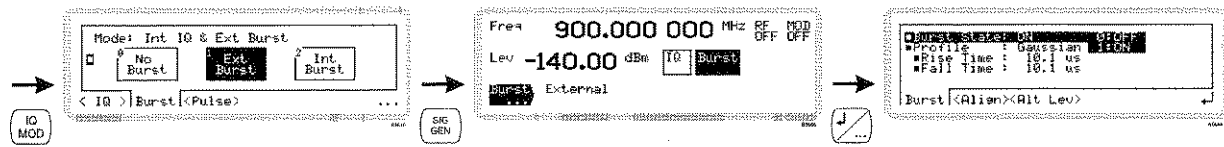

Fig. 3-51 Repeat length (example)

Note: When you set up an alternate level burst event, make sure that the alternate level event occurs before the burst gate (Marker 1) event, as shown in Fig. 3-45.



External burst interfaces

When external burst is selected, the connector allocations are as follows:

IQ modulation	Burst control interface	Alternate level control interface
External analog	Auxiliary D-type	Auxiliary D-type
External digital	LVDS	LVDS
Generic	LVDS	LVDS

Bursting is controlled by logic levels applied to the auxiliary port connector (A/B burst attenuation control and burst gate in).

Burst gate	A/B burst attenuation	Result
Contact 11	Contact 5	
1	0	Levels the carrier using the A setting (nominal output power)
1	1	Levels the carrier using the B setting (x dB below nominal output power)
0	X	Suppresses the RF output

Do not change levels while Burst is enabled (logic 1) as the transition between levels is uncontrolled.

IQ mod. RTBB

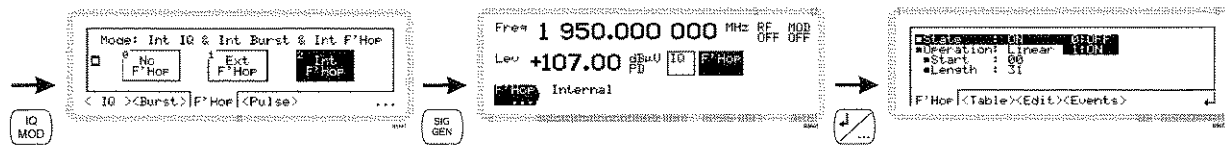

Frequency hopping

From this screen you can:

- Turn frequency hopping on or off
- Configure linear or random hopping
- View, set up and delete frequency offset values and addresses.

Note: you will see no hopping output until you have set up some frequency hopping events (markers) — see page 3-75.

Frequency hopping set-up

- 1 Press **IQ MOD** to see the IQ modulation mode screen.
- 2 Touch **<F'Hop>**, and then the appropriate soft box to choose internal or external operation. **FHOP: SOUR** page 4-80
- 3 Press **SIG GEN** to show the main screen, and touch the **F'Hop** soft box to select the function. Touch **F'Hop** and press **↵** to view the frequency hopping screen (Fig. 3-52).



Fig. 3-52 Frequency hopping — F'Hop

Frequency hopping menu — <F'hop>

■ **State**

FHOP: STAT page 4-80

Use the numeric keypad to turn frequency hopping on or off.

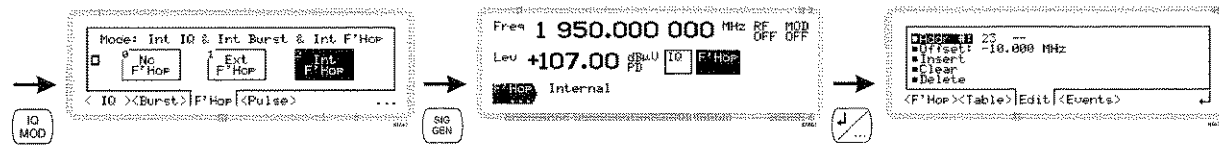

■ **Operation**

FHOP: INT: OPER page 4-78

Use the numeric keypad to specify **linear** operation (frequency offset table indexed sequentially) or **random** operation (frequency offset table indexed randomly).

■ **Linear operation**

■ **Start** Use the numeric keypad or $\frac{\times 10}{\uparrow}$ and $\frac{\times 10}{\downarrow}$ keys to define the initial hopping address.

■ **Length** Use the numeric keypad or $\frac{\times 10}{\uparrow}$ and $\frac{\times 10}{\downarrow}$ keys to define the length of the hopping sequence.

■ **Random operation**

The instrument selects at random from any of the 32 frequency offsets in the table.

■ **PN Code** Use the numeric keypad or $\frac{\times 10}{\uparrow}$ and $\frac{\times 10}{\downarrow}$ keys to define the random sequence used.

Frequency hopping menu — <Table>

You can view up to four screens of a table of frequency offset values by scrolling up and down using the \downarrow and \uparrow keys. The frequency offset values are arranged in groups of eight.

Touch <Table> or press $\langle \text{TAB} \rangle$ to display the table screen (Fig. 3-53).

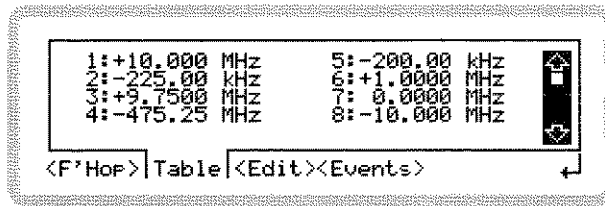
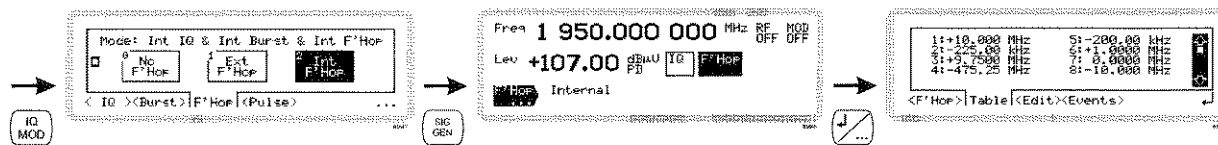

Fig. 3-53 Frequency hopping — view offset table

IO mod. RTBB



Frequency hopping — <Edit>

From this menu, you can change or delete the 32 frequency offset values shown in the table.

Touch <Edit> or press **<TAB>** to display the offset editing screen (Fig. 3-54).



Fig. 3-54 Frequency hopping — edit offset table

■ Addr

FHOP:INT:LIN:ADDR page 4-77

Use the numeric keypad, rotary control or **<+10>** and **<-10>** keys to change the hopping address. As the value changes, the associated frequency offset values changes too.

■ Offset

FHOP:INT:TRAN:LIST page 4-78

Use the numeric keypad to change the frequency offset value.

■ Insert

FHOP:FLIS:INS page 4-76

Press ENTER to insert an additional frequency offset value (0.000 MHz) at the currently-indicated address. The frequency offset values between this address and address 31 all move up one address, the value originally at address 31 disappearing from the table.

■ Clear

FHOP:FLIS:CLE page 4-76

Use the numeric keypad to clear one or more of the frequency offset values in the table. Clearing sets the frequency offset to 0 Hz.

- | | | |
|----------|-------------------|---|
| 0 | <i>Addr xx</i> | Clears the frequency offset value at the indicated address |
| 1 | <i>Addr xx-31</i> | Clears the frequency offset values from the indicated address to the end of the table |
| 2 | <i>Addr 00-31</i> | Clears the whole table. |

■ Delete

FHOP:FLIS:DEL page 4-76

Press ENTER to delete the frequency offset value at the currently-indicated address. The frequency offset values between this address and address 31 all move down one address, the now-unoccupied address 31 being set to 0 Hz.

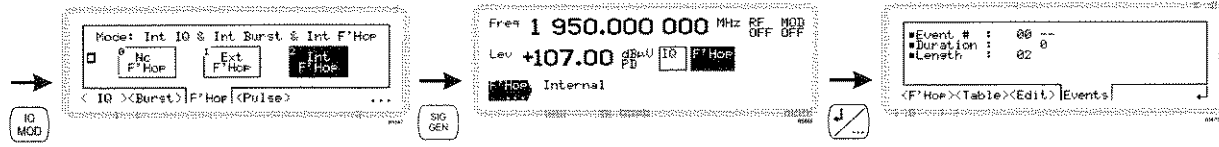

Frequency hopping — <Events>

From this menu, you can define the event number, duration and length to create the markers. Note that you need to set up the markers before hopping is possible.

Touch <Events> or press <TAB> to display the hopping event screen (Fig. 3-55).



Fig. 3-55 Frequency hopping — setting events

IQ mod. RTTB

■ Event #

FHOP:INT:TRAN:LIST page 4-79

Use the numeric keypad to specify the event (transition point) number. Fig. 3-56 shows an example of this.

■ Duration

FHOP:INT:TRAN:LIST page 4-79

Use the numeric keypad to specify the duration (offset) of the specified event. Fig. 3-56 shows an example of this.

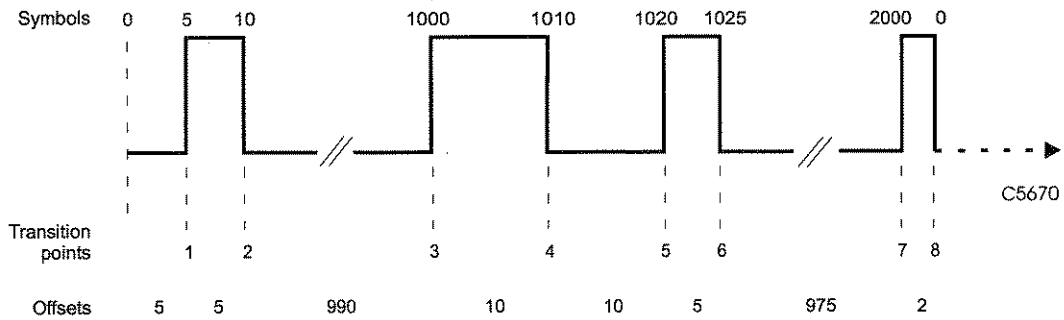
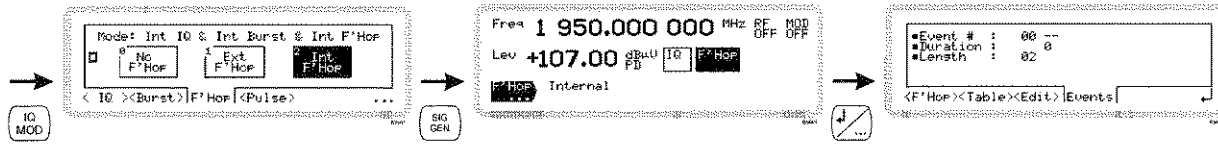

Fig. 3-56 Transition points (example)



Length

FHOP: INT: TRAN: REP page 4-79

Use the numeric keypad to specify the repeat length of the hopping marker. This is the transition number from which the hopping pattern repeats. Fig. 3-57 shows an example of this.

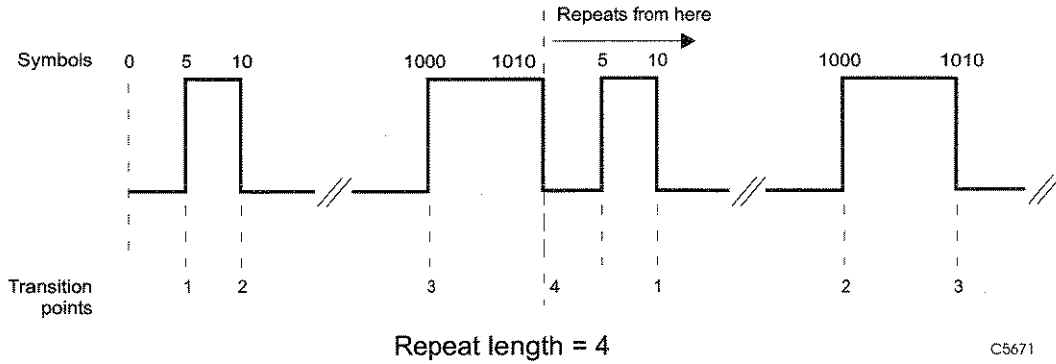
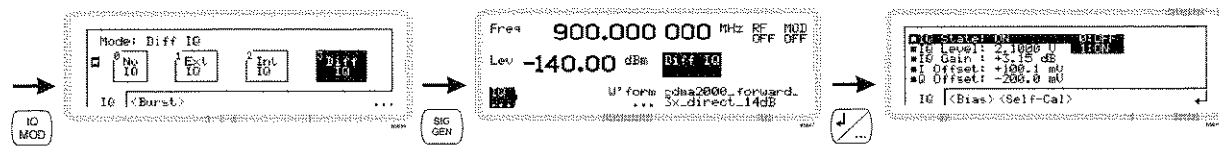

Fig. 3-57 Repeat length (example)



Differential IQ outputs

Note: This section applies only if you have differential IQ outputs (Option 009) fitted to your instrument.

This option provides the instrument with balanced baseband I and Q outputs for feeding devices with differential inputs. The additional signals that appear on \bar{I} OUT and \bar{Q} OUT are of equal magnitude to the I and Q signals, but are opposite in polarity. The I and Q outputs or the \bar{I} and \bar{Q} outputs can be used on their own to provide an unbalanced output. With differential IQ mode selected, the RF OUTPUT is CW only.

From these menus, you can turn differential IQ on and off, set overall and relative signal amplitudes, and set differential voltages between the IQ signals and their corresponding complementary signals. You can set common-mode voltages for the I and Q outputs separately, and then vary them together or independently. You can then access the ARB and real-time baseband waveform set-ups to configure and run the modulations.

Differential IQ

Differential IQ set-up

- 1 Press **IQ MOD** to see the IQ modulation mode screen. Select Diff IQ modulation.
- 2 Press **SIG GEN** to show the main screen, and touch the **Diff IQ** soft box to select the function. Touch **IQ** and press **↙** to view the differential IQ screen (Fig. 3-58).



Fig. 3-58 Differential IQ

Differential IQ — <IQ>

■ IQ State

IQ:STAT page 4-103

Use the numeric keypad to turn differential IQ on or off.

When differential IQ is OFF, the signal is removed from the \bar{I} OUT and \bar{Q} OUT connectors but bias and offset voltages remain. To remove the output signal and also zero the bias and offset voltages, press **MOD ON/OFF**.

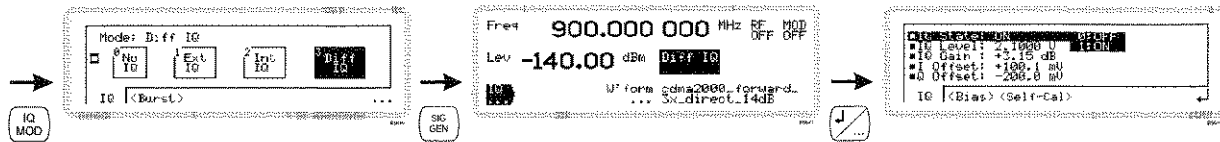

■ **IQ Level**

IQ:DIFF:LEV page 4-97

Use the numeric keypad to specify the amplitude of the signal component.

■ **IQ Gain**

IQ:DIFF:GAIN page 4-95

Use the numeric keypad to specify the relative amplitudes of the I and Q signals.

Adding gain (+x dB) to the signal has the effect of increasing the magnitude of the I component by

$\frac{x}{2}$ dB whilst decreasing the magnitude of the Q component by the same amount.

Similarly, removing gain (-x dB) from the signal has the effect of increasing the magnitude of the

Q component by $\frac{x}{2}$ dB whilst decreasing the magnitude of the I component by the same amount.

In each case, the set output power is maintained provided that the power is split equally between the I and Q components.

■ **I Offset**

IQ:DIFF:ICH:OFFS page 4-96

Use the numeric keypad to specify the differential voltage between I and \bar{I} .

■ **Q Offset**

IQ:DIFF:QCH:OFFS page 4-98

Use the numeric keypad to specify the differential voltage between Q and \bar{Q} .

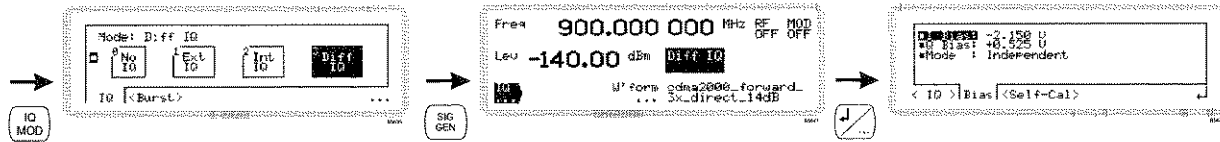

Differential IQ — <Bias>

From this menu, you can vary the I and Q bias voltages and define whether they are coupled or independent.

From the differential IQ menu of Fig. 3-58, touch <Bias> or press **<TAB>** to display the bias setup screen (Fig. 3-59).

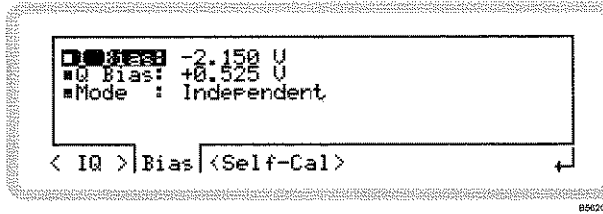

Fig. 3-59 Bias setup, differential IQ

Differential IQ

■ **I Bias**

IQ:DIFF:ICH:BIAS page 4-95

Use the numeric keypad to specify the common-mode I voltage.

■ **Q Bias**

IQ:DIFF:QCH:BIAS page 4-97

Use the numeric keypad to specify the common-mode Q voltage.

■ **Mode**

IQ:DIFF:IQBIAS page 4-96

Use the numeric keypad to specify the differential IQ bias mode:

- 0** *Independent* Allows independent control of the I and Q bias voltages.
- 1** *Coupled* I and Q bias voltages are varied simultaneously. The Q bias voltage is set equal to the I bias voltage when the I bias voltage is varied, and the I bias voltage is set equal to the Q bias voltage when the Q bias voltage is varied.

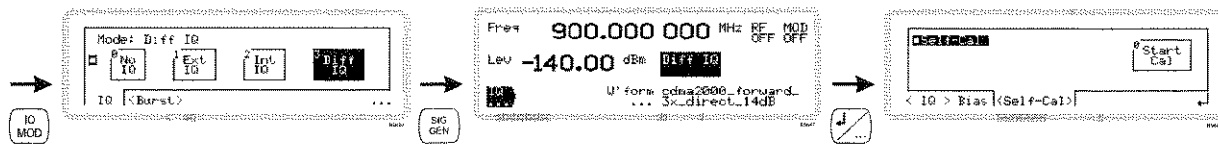

Differential IQ — <Self-Cal>

For optimum performance when in the IQ mode, run a self-calibration to make sure that the instrument meets its specification. When calibration is valid, the main screen (and a few others) show 'Optimized'. When calibration is invalid (for example, out of frequency range) 'Optimized' no longer appears; instead, a question mark appears in the IQ softbox: `Diff IQ?`

From this menu, you can:

- Start and stop self-calibration
- Define whether self-calibration is performed at a spot frequency or over a band
- Define manual or automatic self-calibration

From the differential IQ menu of Fig. 3-58, touch `<Self-Cal>` or press `<TAB>` to display the self-calibration screen (Fig. 3-60).

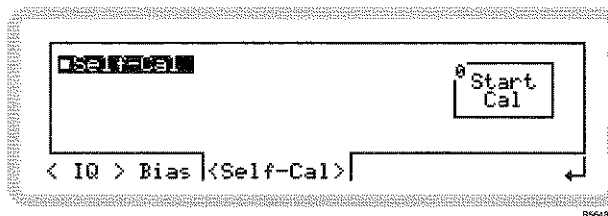
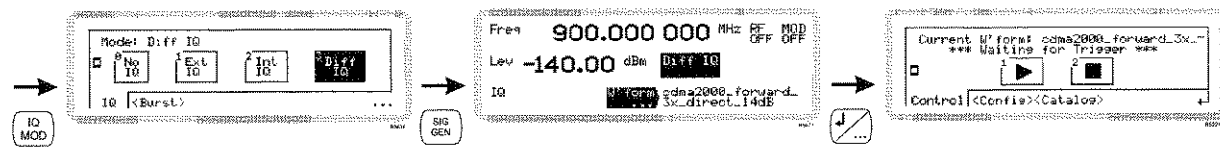

Fig. 3-60 Self-calibration

■ Self-Cal

Touch the `Start Cal` soft box, and the instrument performs the self-calibration operation chosen from the *Mode* menu.



Differential IQ waveform set-up

From this screen you can set up the instrument's differential IQ signal generation. To do this, you use the ARB set-up menu, which you access from the main screen below.

- 1 Press to see the IQ modulation mode screen. Touch the soft box.
- 2 Press to show the main screen, and touch the soft box to select the function. Touch to view the ARB waveform menu main screen (Fig. 3-61).

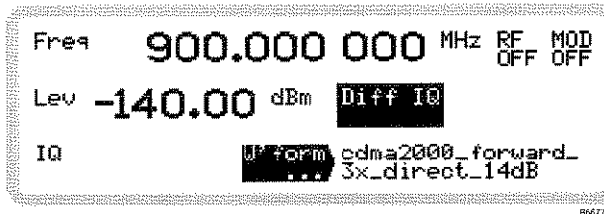
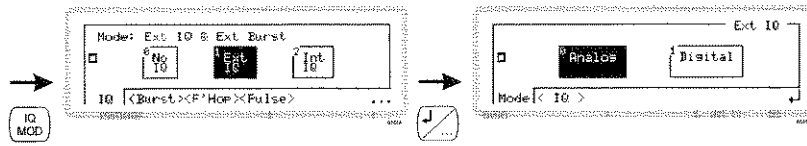

Fig. 3-61 ARB set-up main screen

Now press and follow the ARB generator set-up, starting on page 3-39.



External IQ modulation — analog or digital

If you have real-time baseband Option 008 fitted, you need to configure external IQ modulation as analog or digital before selecting other submenus. Other options default to analog modulation.

- 1 Configure the modulation mode for external IQ modulation by pressing **IQ MOD** to see the IQ modulation mode screen and touching **Ext IQ** (Fig. 3-62). This screen's appearance may differ, depending on the options fitted to your instrument.

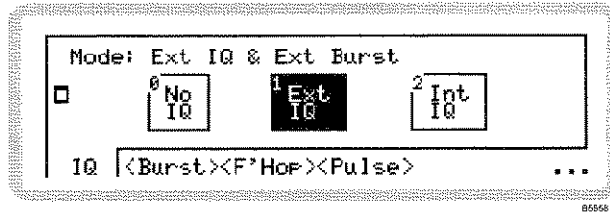

Fig. 3-62 Ext IQ modulation selected

- 2 Press **IQ MOD** followed by **Ext IQ** to view the external IQ format menu (Fig. 3-63).

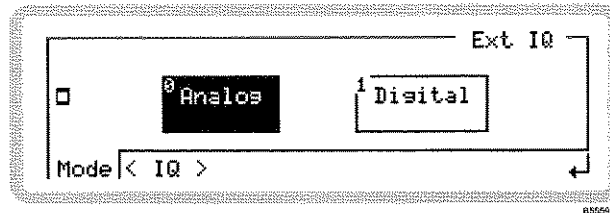
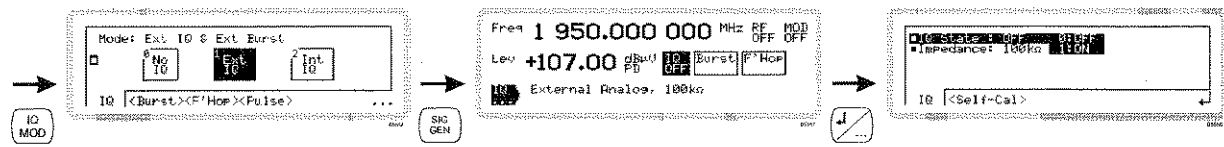

Fig. 3-63 External IQ format

- 3 Touch **Analog** or **Digital** to select the external modulation mode. IQ: SOUR page 4-103
- 4 Press **SIG GEN** to show the main screen.
- 5 Continue with external IQ set-up on the following pages.

Ext. IQ mod.



External IQ set-up — analog

You can configure external analog IQ modulation directly from the *IQ* sub-menus on the main screen.

- 1 Configure the modulation mode for external analog IQ modulation (page 3-83).
- 2 Press **SIG GEN** to show the main screen, and touch the **IQ** soft box to select the function. Touch **IQ** and press **↵** to view the external analog IQ modulation menu (Fig. 3-64).

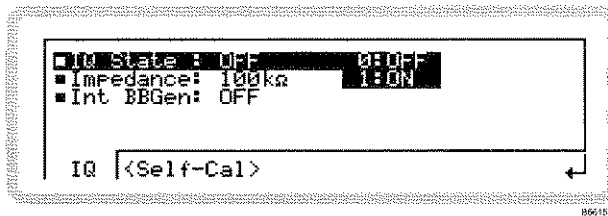

Fig. 3-64 External IQ, analog

From this screen you can:

- Turn external analog IQ modulation on or off
- Choose the input impedance at the external I and Q inputs
- Turn the internal baseband generator on or off
- Set up and perform self-calibration of the I and Q circuits.

External IQ menu — <IQ>

■ **IQ State**

IQ: STAT page 4-103

Use the numeric keypad to turn the external analog IQ modulation on or off:

- 0 Off
- 1 On

■ **Impedance**

IQ: EAN: IMP page 4-98

Use the numeric keypad to specify the impedance of the external analog IQ input:

- 0 50 Ω Use 50 Ω for maximum bandwidth.
- 1 100 kΩ

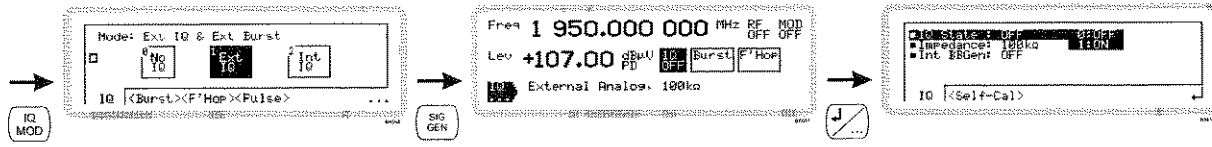

■ *Int BBGen*

Use the numeric keypad to turn the internal baseband generator on or off:

- 0 *Off*
- 1 *On*

For instruments fitted with RTBB Option 008 only:

Pop-up menus — ■ *Format* and ■ *LVDS O/P* — appear.

■ *Format*: use the numeric keypad to select the format for internal baseband modulation.

■ *LVDS O/P*: use the numeric keypad to enable or disable the LVDS output.

After selecting the BBGen format, press to view the main menu (Fig. 3-65).

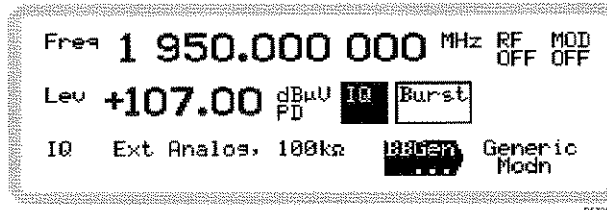
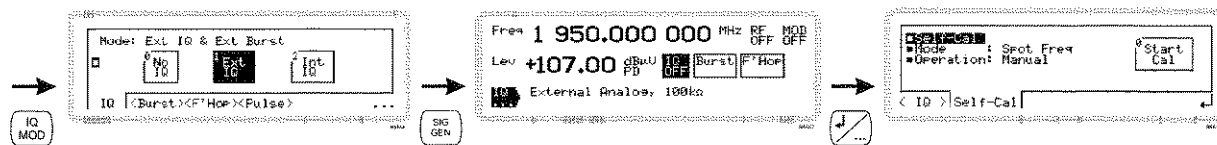

Fig. 3-65 BBGen main menu

Touch and press to view the Generic menu (page 3-57) or the Tones menu (page 3-62), which you now use to set up the internal baseband generator.

Ext. IQ mod.



External IQ menu — <Self-Cal>

■ Self-Cal

For optimum performance when in the IQ mode, run a self-calibration to make sure that the instrument meets its specification. When calibration is valid, the main screen (and a few others) shows 'Optimized'. When calibration is invalid (for example, out of frequency range) 'Optimized' no longer appears; instead, a question mark appears in the IQ softbox: IQ?.

Run a self-calibration to make sure that the instrument meets the requirement specification. Touch the Start Cal soft box, and the instrument performs the IQ self-calibration operation chosen below. An *Abort Cal* soft box appears, allowing you to stop the self-calibration if you wish.

■ Mode

Use the numeric keypad to specify the external IQ self-calibration mode:

- 0 *Spot Freq* Performs an IQ self-calibration at the current frequency.
- 1 *Freq Band* A pop-up menu — **■ Freq Span** — appears. Use the numeric keypad to define the frequency span ($\pm 10, 20, 40$ or 60 MHz with respect to the current carrier frequency) over which the IQ self-calibration is performed.
- 2 *Multi Band* <Table> and <Edit> soft tabs appear, allowing you to define up to four frequency bands over which the IQ self-calibration is performed. Use the numeric keypad to enter start and stop frequencies for each band.
- 3 *Freq List* <Table> and <Edit> soft tabs appear. Use the numeric keypad to define up to 500 list frequencies at which the IQ self-calibration is performed.

■ Operation

Use the numeric keypad to specify how external IQ self-calibration starts when *Spot Freq* mode is selected:

- 0 *Manual* Spot frequency IQ self-calibration starts when the Start Cal soft box is pressed.
- 1 *Auto* IQ self-calibration starts automatically whenever the carrier frequency changes.

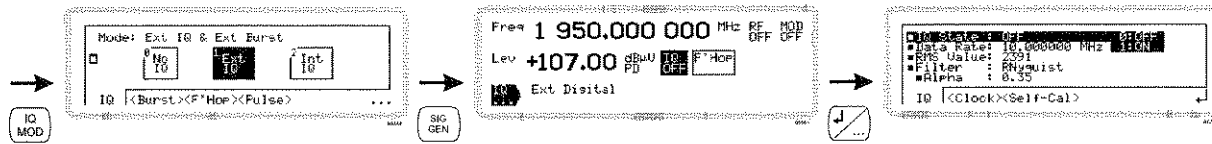

External IQ set-up — digital (real-time baseband Option 008 only)

You can configure external digital IQ modulation directly from the *IQ* sub-menus on the main screen.

- 1 Configure the modulation mode for external digital IQ modulation (page 3-83).
- 2 Press **SIG GEN** to show the main screen, and touch the **IQ** soft box to select the function. Touch **IQ** and press **↙** to view the external digital IQ modulation menu (Fig. 3-66).

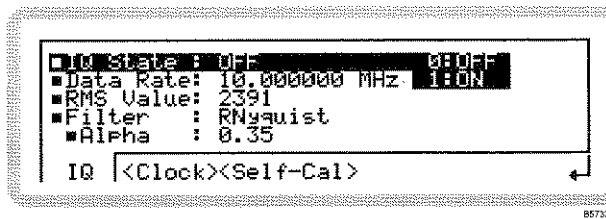

Fig. 3-66 External IQ, digital

Ext. IQ mod.

From this screen you can:

- Turn external digital IQ modulation on or off
- Choose the rate and RMS value for the incoming digital IQ data
- Choose the type of filtering (or none) to be applied to the incoming digital IQ data
- Set up and perform self-calibration of the I and Q circuits.
- Enable or disable specific IQ errors.

External IQ menu — <IQ>

■ **IQ State**

IQ:STAT page 4-103

Use the numeric keypad to turn the external digital IQ modulation on or off:

- 0 Off
- 1 On

■ **Data Rate**

IQ:EDIG:SRAT page 4-102

Enter up to nine characters (including decimal point) and terminate with **kHz** or **MHz** or **% μV** or **ms mV**.

■ **RMS Value**

IQ:EDIG:RMS page 4-102

Use the numeric keypad to specify the RMS value of the external IQ signal.

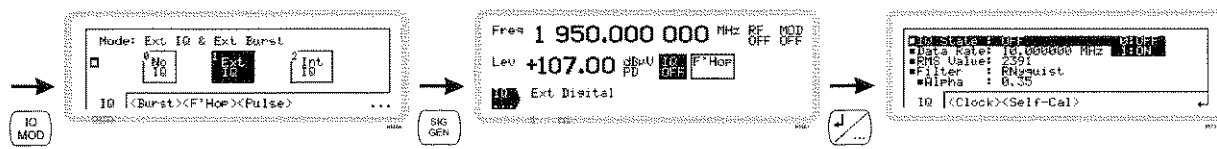

■ **Filter**

IQ:EDIG:FILT page 4-101

A pop up selection of filter types (or none) appears. Use the numeric keypad to specify the filtering to be applied to the digital IQ data entering the instrument.

If a filter parameter is displayed, you can select it (use ) and change it if required.

External IQ menu — <Clock

■ **Clock**

IQ:DM:CLOC:EXT:SYNC page 4-114

Use the numeric keypad to specify **internal** or **external** clock source.

If you choose an **external** clock, scroll to **Sync**. Apply the clock to contacts 42 (CLK_IN+) and 8 (CLK_IN-) of the LVDS connector (Chapter 2). Press [ENTER] to start synchronizing the internal and external clocks. An 'Alignment Complete' message is displayed when synchronization finishes.

External IQ menu — <Self-Cal>

■ **Self-Cal**

For optimum performance when in the IQ mode, run a self-calibration to make sure that the instrument meets its specification. When calibration is valid, the main screen (and a few others) shows 'Optimized'. When calibration is invalid (for example, out of frequency range) 'Optimized' no longer appears; instead, a question mark appears in the IQ softbox:  .

Run a self-calibration to make sure that the instrument meets the requirement specification. Touch the  soft box, and the instrument performs the IQ self-calibration operation chosen below. An *Abort Cal* soft box appears, allowing you to stop the self-calibration if you wish.

■ **Mode**

CAL:IQUS:MODE page 4-174

Use the numeric keypad to specify the external IQ self-calibration mode:

- 0 *Spot Freq* Performs an IQ self-calibration at the current frequency.
- 1 *Freq Band* A pop-up menu — **■ Freq Span** — appears. Use the numeric keypad to define the frequency span (with respect to the current carrier frequency) over which the IQ self-calibration is performed.



■ Operation

CAL: IQUS: OPER page 4-174

Use the numeric keypad to specify how external IQ self-calibration starts when *Spot Freq* mode is selected:

- 0 *Manual* Spot frequency IQ self-calibration starts when the soft box is pressed.
- 1 *Auto* IQ self-calibration starts automatically whenever the carrier frequency changes.

Ext. IQ mod.

1

2

3

4

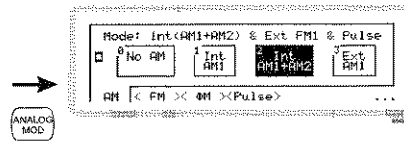

Analog modulation

Press **ANALOG MOD** to see the analog modulation mode screen (Fig. 3-67). Use this to choose the type of analog modulation to apply to the RF carrier. This screen may differ slightly, depending on the options fitted to your instrument.

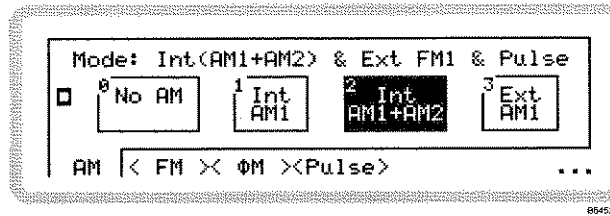

Fig. 3-67 Analog modulation mode

- 1 The screen shows the available configurations for the type of modulation selected on the soft tab at the bottom of the screen. The current modulation configuration is highlighted.
- 2 Touch any soft tab or scroll along the soft tabs using **<TAB>** to see the configurations of the various forms of modulation — AM, FM, Phase and Pulse.
- 3 Touch the appropriate soft box (for example, **Int AM1**) to choose the modulation required or switch modulation off by touching the appropriate soft box (for example, **No AM**).

For example, in Fig. 3-67 the current selection is for two internal AM signals together with an external FM signal and pulse.

- 4 The three dots in the right-hand bottom corner of the screen show that you can press **J/...** to see a relevant sub-menu that allows you to set up basic modulation parameters (for example, AM depth) directly. This is explained on pages 3-93 to 3-101.
- 5 Press **J/...** again to view the modulation mode screen.
- 6 Press **SIG GEN** to view the main screen, showing the current modulation mode.

Path set-up

Before setting up the analog internal/external sources and modulation paths, you may find it helpful to look at Fig. 3-68.

It shows the various parameters that may be set up, and the menus in which you can find them, for amplitude modulation. The FM and Φ M modulation diagrams would be very similar, and so are not repeated.

While this diagram does not set out to portray accurately the instrument's hardware, it does represent the effect of the menus on the instrument's operation.

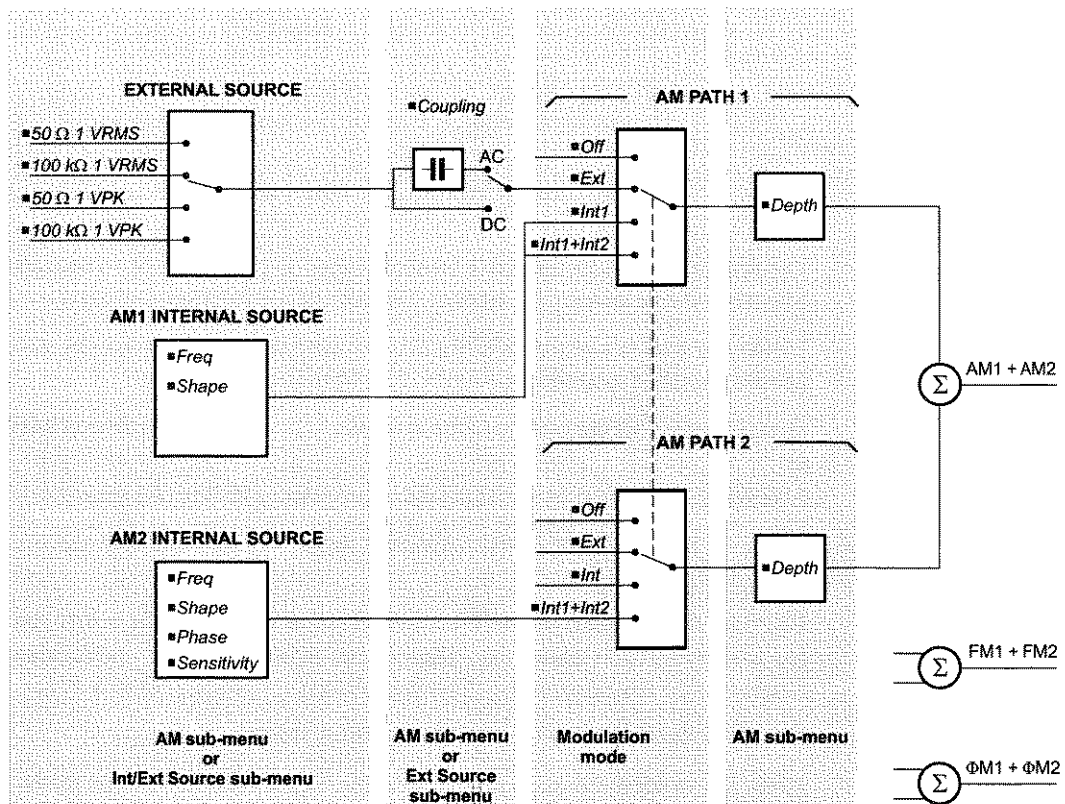

C5210

Fig. 3-68 Path set-up

Parameters that can be adjusted are shown as (for example) ■Freq.

Apart from selecting the signal path(s), all parameters can be adjusted from the AM, FM and Φ M sub-menus on pages 3-93 to 3-99. They can also be adjusted from the internal source sub-menus on pages 3-102 to 3-105.

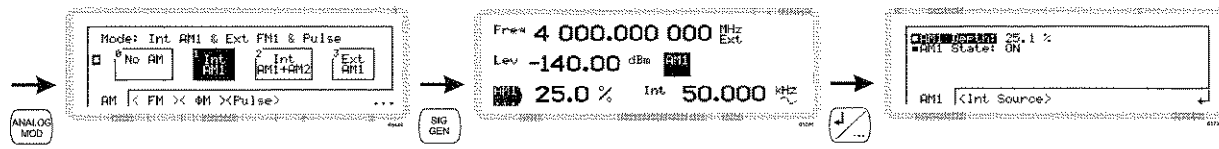

AM1 set-up

Use this menu to apply amplitude modulation (on path 1) to the internal source, or to configure the input of the external source.

- 1 Configure the modulation mode for internal or external modulation (page 3-91).
- 2 Press **(SIG GEN)** to show the main screen, and touch the **AM1** soft box to select the function (Fig. 3-69).

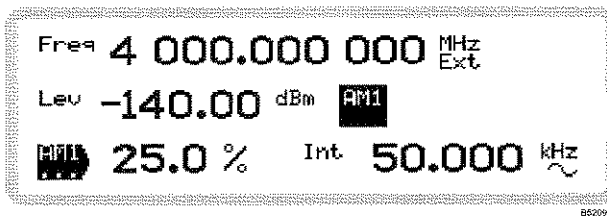

Fig. 3-69 AM1 main screen

Set AM depth or internal modulation frequency directly:

- 1 Touch the relevant function label on the screen (**AM1** or **Int**).
- 2 Enter the value using the numeric keypad. Terminate using the appropriate units key.

AM1 sub-menu — <AM1>

Touch the **AM1** soft box to select the function. Touch **AM1** and press **(↵)** to view the AM1 sub-menu (Fig. 3-70).

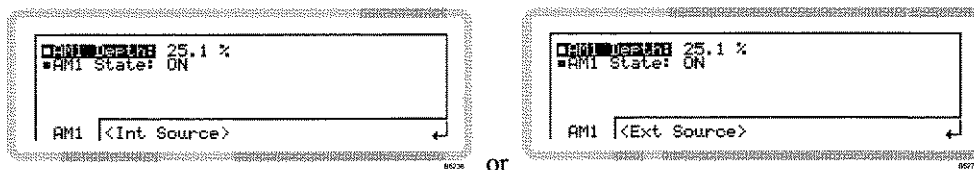

Fig. 3-70 AM1 sub-menu

From this menu you can:

- Specify the modulation depth
- Turn AM1 modulation source on and off.

■ **AM1 Depth**

AM page 4-51

Use the numeric keypad or the **(+10 ↑)** and **(x10 ↓)** keys to specify the AM1 modulation depth (%).

Analog mod.

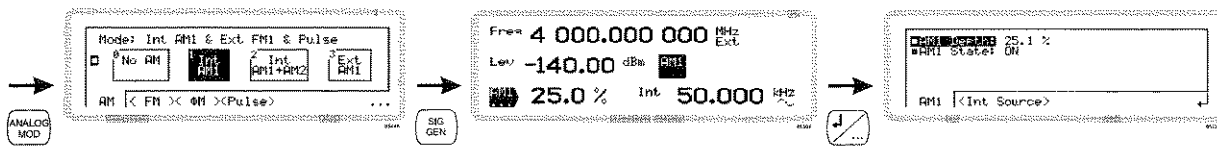

■ **AM1 State**

OUTP: MOD: AM page 4-20

Use the numeric keypad to turn AM1 modulation source on or off:

- 0 Off
- 1 On

AM1 sub-menu — <Int Source> or <Ext Source>

Either of these soft tabs may appear, depending on whether you have defined the source for AM1 as internal or external on the modulation mode menu (page 3-91).

<Int Source>

From this menu you can:

- Specify the source's frequency and waveshape.

Follow the instructions for ■ *Int Freq* and ■ *Int Shape* on page 3-102.

<Ext Source>

From this menu you can:

- Specify the coupling of the external source (DC or AC)
- Define the input impedance and sensitivity of the inputs.

Follow the instructions for ■ *Coupling*, ■ *Impedance* and ■ *Sensitivity* on page 3-105.

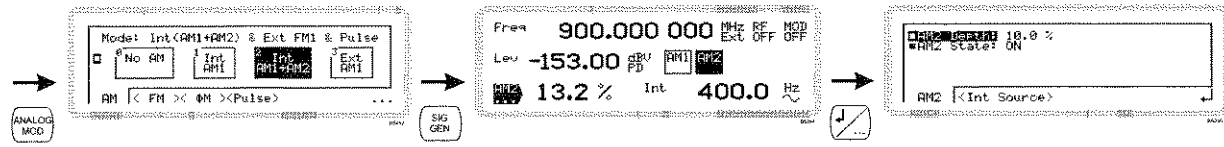

AM2 set-up

Use this menu to apply amplitude modulation (on path 2) to the internal source.

The AM2 path only becomes available when you select composite modulation (AM1 + AM2).

Set up the AM2 path exactly as the AM1 path, but using the **AM2** function label.

AM2 sub-menu — <AM2>

From this menu you can:

- Specify the modulation depth
- Turn AM2 modulation source on and off.

■ AM2 Depth

AM page 4-51

Use the numeric keypad or the $\times 10 \downarrow$ and $\div 10 \uparrow$ keys to specify the AM2 modulation depth (%).

■ AM2 State

OUTP:MOD:AM page 4-20

Use the numeric keypad to turn AM2 modulation source on or off:

- 0 Off
- 1 On

AM2 sub-menu — <Int Source>

From this menu you can:

- Specify the source's frequency and waveshape
- Define the phase relationship of one path to another
- Set the resolution of the rotary control when defining the phase relationship.

Follow the instructions for ■ *Int Freq*, ■ *Int Shape*, ■ *Phase Diff* and ■ *Sensitivity* on page 3-104.

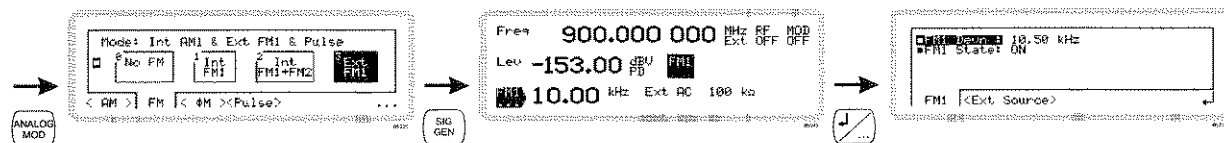

FM1 set-up

Use this menu to apply frequency modulation (on path 1) to the internal source, or to configure the input of the external source.

- 1 Configure the modulation mode for internal or external modulation (page 3-91).
- 2 Press **(SIG GEN)** to show the main screen, and touch the **[FM1]** soft box to select the function (Fig. 3-71).

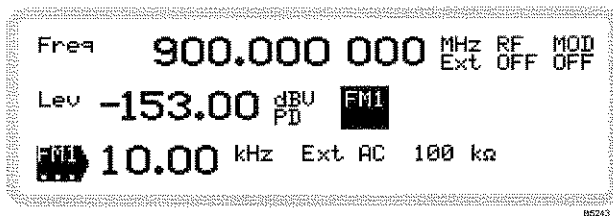

Fig. 3-71 FM1 main screen

Set FM deviation or internal modulation frequency directly:

- 1 Touch the relevant function label on the screen (**[FM1]** or **[Int]**).
- 2 Enter the value using the numeric keypad. Terminate using the appropriate units key.

FM1 sub-menu — <FM1>

Touch the **[FM1]** soft box to select the function. Touch **[FM1]** and press **[J/...]** to view the FM1 sub-menu (Fig. 3-72).

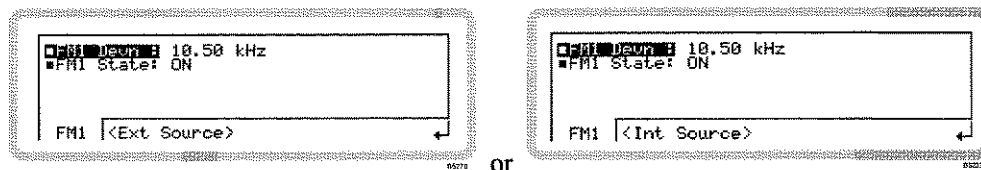

Fig. 3-72 FM1 sub-menu

From this menu you can:

- Specify the deviation of the modulating frequency
- Turn FM1 modulation source on and off.

■ FM1 Devn

Use the numeric keypad or the **(x10 ↓)** and **(÷10 ↑)** keys to specify the FM1 deviation.

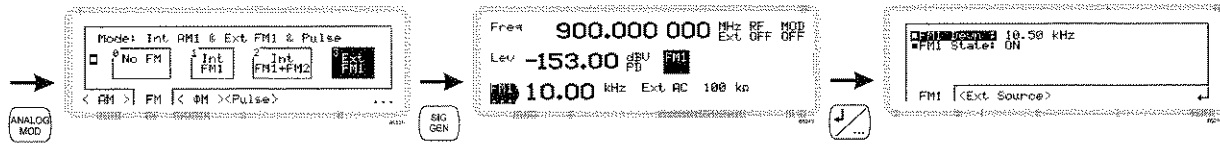

■ **FM1 State**

OUTP: MOD: FM page 4-22

Use the numeric keypad to turn FM1 modulation source on or off:

- 0 Off
- 1 On

FM1 sub-menu — <Int Source> or <Ext Source>

Either of these soft tabs may appear, depending on whether you have defined the source for FM1 as internal or external on the modulation mode menu (page 3-91).

<Int Source>

From this menu you can:

- Specify the source's frequency and waveshape.

Follow the instructions for ■ *Int Freq* and ■ *Int Shape* on page 3-102.

<Ext Source>

From this menu you can:

- Specify the coupling of the external source (DC or AC)
- Perform a DC null on the input signal
- Define the input impedance and sensitivity of the inputs.

Follow the instructions for ■ *Coupling*, ■ *DCFM Null*, ■ *Impedance* and ■ *Sensitivity* on page 3-105.

Analog mod.

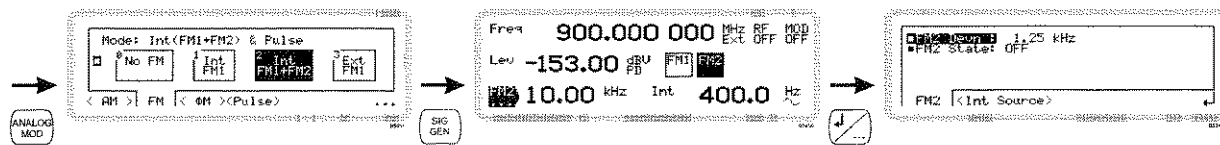

FM2 set-up

Use this menu to apply frequency modulation (on path 2) to the internal source.

The FM2 path only becomes available when you select composite modulation (FM1 + FM2).

Set up the FM2 path exactly as the FM1 path, but using the **FM2** function label.

FM2 sub-menu — <FM2>

From this menu you can:

- Specify the deviation of the modulating frequency
- Turn FM2 modulation source on and off.

■ FM2 Devn

FM page 4-83

Use the numeric keypad or the $\times 10 \downarrow$ and $\uparrow \div 10$ keys to specify the FM2 deviation.

■ FM2 State

OUTP:MOD:FM page 4-22

Use the numeric keypad to turn FM2 modulation source on or off:

- 0 Off
- 1 On

FM2 sub-menu — <Int Source>

From this menu you can:

- Specify the source's frequency and waveshape
- Define the phase relationship of one path to another
- Set the resolution of the rotary control when defining the phase relationship.

Follow the instructions for ■ Int Freq, ■ Int Shape, ■ Phase Diff and ■ Sensitivity on page 3-104.

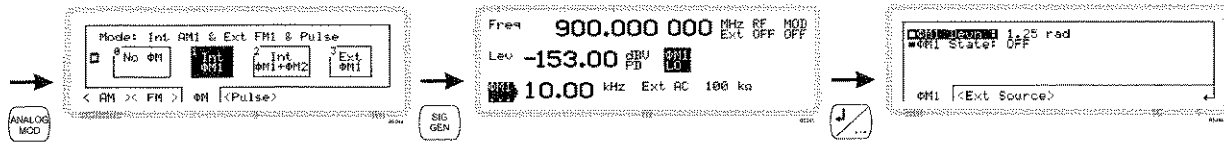

Φ M1 set-up

Use this menu to apply phase modulation (on path 1) to the internal source, or to configure the input of the external source.

- 1 Configure the modulation mode for internal or external modulation (page 3-91).
- 2 Press **SIG GEN** to show the main screen, and touch the **Φ M1** soft box to select the function (Fig. 3-73).

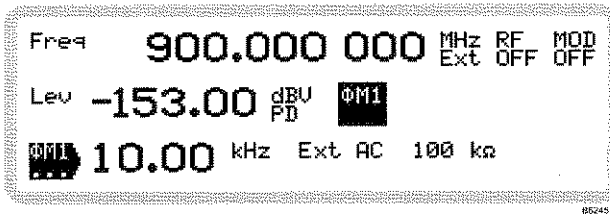

Fig. 3-73 Φ M1 main screen

Set Φ M deviation or internal modulation frequency directly:

- 1 Touch the relevant function label on the screen (**Φ M1** or **Int**).
- 2 Enter the value using the numeric keypad. Terminate using the appropriate units key.

Φ M1 sub-menu — **< Φ M1>**

Touch the **Φ M1** soft box to select the function. Touch **Φ M1** and press **J** to view the Φ M1 sub-menu (Fig. 3-74).

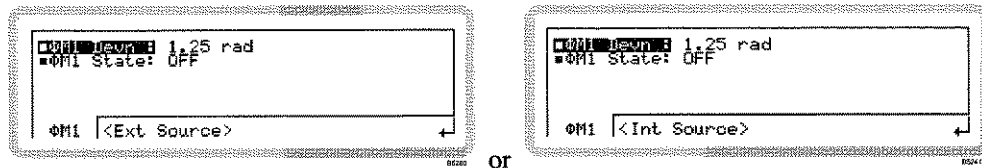

Fig. 3-74 Φ M1 sub-menu

From this menu you can:

- Specify the deviation of the modulating frequency
- Turn Φ M1 modulation source on and off.

■ Φ M1 Devn

Φ M page 4-135

Use the numeric keypad or the **x10** and **+10** keys to specify the Φ M1 deviation.

Analog mod.

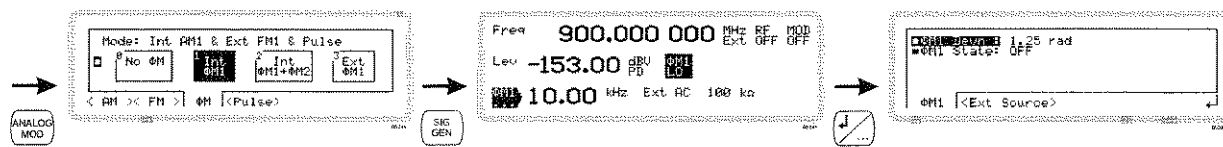

■ Φ M1 State

OUTP:MOD:PM page 4-23

Use the numeric keypad to turn Φ M1 modulation source on or off:

- 0 Off
- 1 On

Φ M1 sub-menu — <Int Source> or <Ext Source>

Either of these soft tabs may appear, depending on whether you have defined the source for Φ M1 as internal or external on the modulation mode menu (page 3-91).

<Int Source>

From this menu you can:

- Specify the source's frequency and waveshape.

Follow the instructions for ■ *Int Freq* and ■ *Int Shape* on page 3-102.

<Ext Source>

From this menu you can:

- Define the input impedance and sensitivity of the inputs.

Note: Φ M coupling is always AC.

Follow the instructions for ■ *Impedance* and ■ *Sensitivity* on page 3-105.

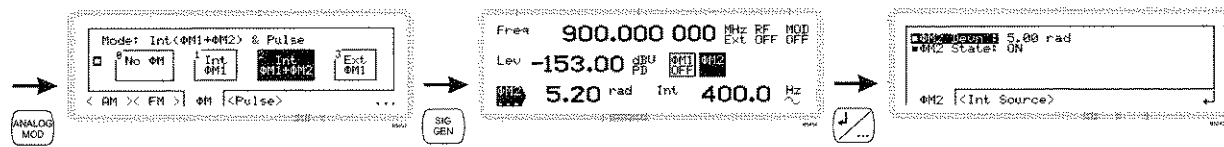

Φ M2 set-up

Use this menu to apply phase modulation (on path 2) to the internal source.

The Φ M2 path only becomes available when you select composite modulation (Φ M1 + Φ M2).

Set up the Φ M2 path exactly as the Φ M1 path, but using the Φ M2 function label.

Φ M2 sub-menu — $\langle \Phi$ M2 \rangle

From this menu you can:

- Specify the deviation of the modulating frequency
- Turn Φ M2 modulation source on and off.

■ Φ M2 Devn

PM page 4-135

Use the numeric keypad or the $\times 10 \downarrow$ and $\pm 10 \uparrow$ keys to specify the Φ M2 deviation.

■ Φ M2 State

OUTP:MOD:PM page 4-23

Use the numeric keypad to turn Φ M2 modulation source on or off:

- 0 Off
- 1 On

Φ M2 sub-menu — \langle Int Source \rangle

From this menu you can:

- Specify the source's frequency and waveshape
- Define the phase relationship of one path to another
- Set the resolution of the rotary control when defining the phase relationship.

Follow the instructions for ■Int Freq, ■Int Shape, ■Phase Diff and ■Sensitivity on page 3-104.

Analog mod.

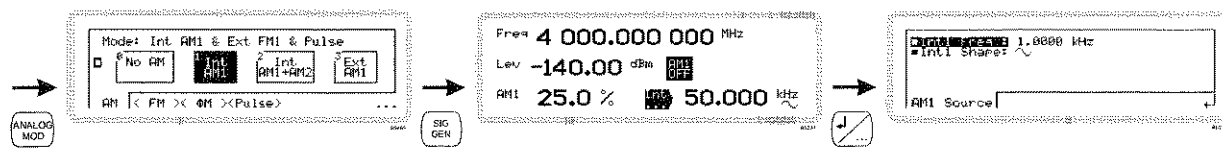

Internal source set-up

The internal source can modulate the carrier through up to three modulation paths (see Fig. 3-68). You can configure these either:

- via the *AM/FM/PM* sub-menus on the main screen, or
- directly from the *Int* sub-menu on the main screen.

In this section, we set up the internal source directly.

Modulation path 1

- 1 Configure the modulation mode to select a first modulation path (for example, AM1) (page 3-91).
- 2 Press **SIG GEN** to show the main screen. Touch the appropriate modulation soft box, followed by **Int**, to select the function. Press **Int** to view the internal source menu for path 1 (Fig. 3-75).

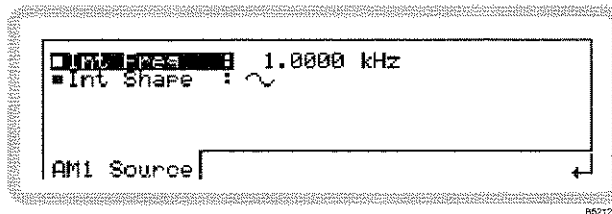

Fig. 3-75 Internal source, modulation path 1

The soft tab shows the modulation path that *Int* is associated with — in this example, *AM1*. It could also be *FM1* or *PM1*.

From this menu you can:

- Specify the source's frequency and waveshape

■ Int Freq

AM: INT: FREQ page 4-53

FM: INT: FREQ page 4-85

PM: INT: FREQ page 4-137

Use the numeric keypad or the **x10** and **÷10** keys to specify the frequency of the internal source.

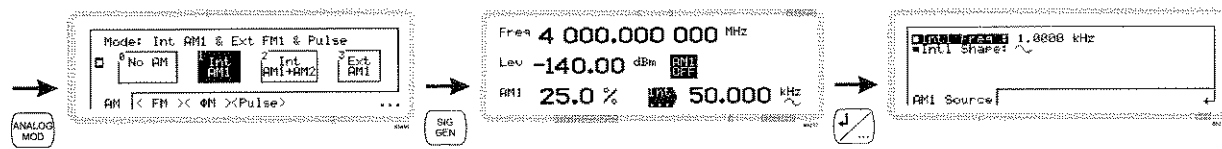

■ Int Shape

AM: INT: SHAP page 4-58

FM: INT: SHAP page 4-90

PM: INT: SHAP page 4-142

Use the numeric keypad to specify the waveshape of the internal source:

- 0 Sine
- 1 Triangle
- 2 Square
- 3 Ramp

Note: Triangle, square and ramp waveforms are specified to lower maximum frequencies than the sine wave's 50 kHz. They can also be used at frequencies up to 50 kHz, but become progressively more distorted (due to filtering of harmonics) as the frequency limit is approached.

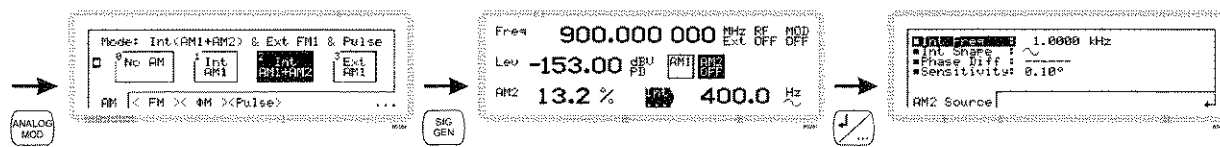

Modulation path 2

Use this menu to set up the internal source for a second modulation path. Set it up the same way as for the first modulation path.

The soft tab shows the modulation path that Int is associated with — in this example, AM2. It could also be FM2 or Φ M2.

From this menu you can:

- Specify the source's frequency and waveshape
- Define the phase relationship of one path to another
- Set the resolution of the rotary control when defining the phase relationship.

■ Int Freq

[AM2 : INT : FREQ page 4-53](#)

[FM2 : INT : FREQ page 4-85](#)

[PM2 : INT : FREQ page 4-137](#)

Use the numeric keypad or the $\times 10 \downarrow$ and $\div 10 \uparrow$ keys to specify the frequency of the internal source.

■ Int Shape

[AM2 : INT : SHAP page 4-58](#)

[FM2 : INT : SHAP page 4-90](#)

[PM2 : INT : SHAP page 4-142](#)

Use the numeric keypad to specify the waveshape of the internal source:

- 0 *Sine*
- 1 *Triangle*
- 2 *Square*
- 3 *Ramp*

■ Phase Diff

[AM2 : INT : PHAS page 4-60](#)

[FM2 : INT : PHAS page 4-92](#)

[PM2 : INT : PHAS page 4-143](#)

Use the numeric keypad or the control knob to set the phase of modulation path 2 relative to modulation path 1.

■ Sensitivity

[AM2 : INT : PHAS : SENS page 4-60](#)

[FM2 : INT : PHAS : SENS page 4-92](#)

[PM2 : INT : PHAS : SENS page 4-144](#)

Use the numeric keypad to specify the sensitivity of the rotary control when setting up the *Phase Difference*:

- 0 *0.01° resolution (fine)*
- 1 *0.1° resolution (medium)*
- 2 *1.0° resolution (coarse)*

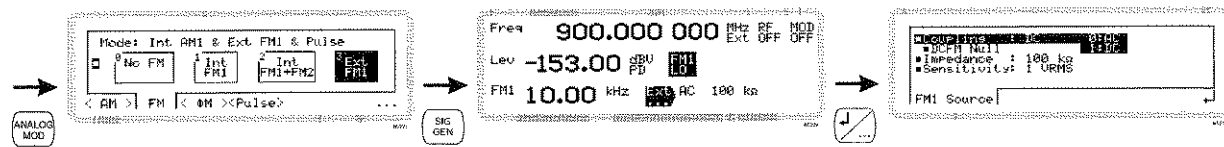

External source set-up

You can configure external sources either:

- via the *AM/FM/ΦM* sub-menus on the main screen, or
- directly from the *Ext* sub-menus on the main screen.

In this section, we set up an external source directly.

External source

- 1 Configure the modulation mode for external modulation (page 3-91).
- 2 Press **(SIG GEN)** to show the main screen. Touch the appropriate modulation soft box, followed by **[Ext ...]**, to select the function. Press **[↓ ...]** to view the external source menu (Fig. 3-76).



Fig. 3-76 External source

The soft tab shows the modulation path that *Ext* is associated with — in this example, *FMI*. It could also be *AMI* or *ΦMI*.

From this menu you can:

- Define the coupling of the external source (DC or AC). Note, however, that ΦM coupling is always AC.
- Perform a DC null on the input signal (FM only)
- Define the input impedance and sensitivity of the inputs.

■ Coupling

AM: EXT: COUP page 4-52
 FM: EXT: COUP page 4-84

Use the numeric keypad to specify the coupling of the external source (not ΦM):

- 0 AC
- 1 DC

In most cases, the instrument achieves the effect of AC coupling by removing any DC offset on which the signal is superimposed.

Analog mod.

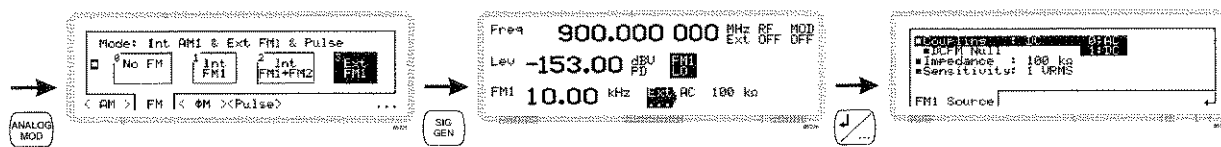

■ **DCFM Null (FM only)**

FM: EXT: DNUL page 4-84

This menu entry appears on the screen only when DC coupling is selected.

The instrument prompts you to apply a ground reference to the external modulation input. Press ENTER to perform a DC nulling operation to reduce any small frequency offsets due to the DC coupling.

■ **Impedance**

AM: EXT: IMP page 4-52

FM: EXT: IMP page 4-84

PM: EXT: IMP page 4-136

Use the numeric keypad to specify the impedance of the external source input:

- 0 50 Ω
- 1 100 k Ω

■ **Sensitivity**

AM: EXT: SENS page 4-53

FM: EXT: SENS page 4-85

PM: EXT: SENS page 4-136

Use the numeric keypad to specify the sensitivity of the external source input:

- 0 1 VRMS 1 V RMS at the input gives the chosen AM depth/FM deviation.
- 1 1 VPK 1 V peak at the input gives the chosen AM depth/FM deviation.

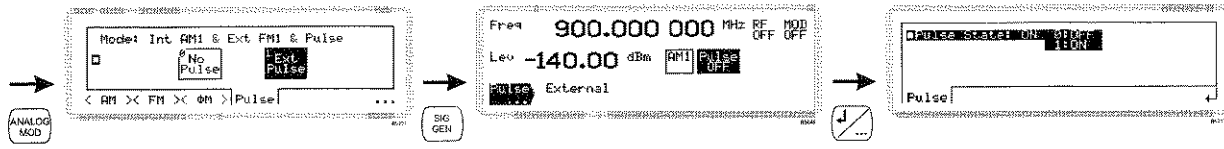

Pulse modulation set-up

Note: This section applies only if you have pulse modulation (Option 006) fitted to your instrument, together with an electronic attenuator (Option 003).

- 1 Press **ANALOG MOD** to see the analog modulation mode screen.
- 2 Touch <Pulse>, and then the appropriate soft box to choose no pulse or external pulse.
- 3 Press **SIG GEN** to show the main screen, and touch the **Pulse** soft box to select the function. Touch **Pulse** and press **↵** to view the pulse modulation menu (Fig. 3-77).



Fig. 3-77 Pulse modulation

■ Pulse State

OUTP: MOD: PULM page 4-23

Use the numeric keypad to turn the pulse modulation source on or off:

- 0 Off
- 1 On

Pulse

Sweep

Press **SWEEP** to see the main sweep screen (Fig. 3-78), from which you can set up all aspects of the instrument's sweep operation.

- If you have not selected a sweep type (Sweep Type is *None*), this is the screen that first appears.
- If you have already selected a sweep type, the sweep *<Control>* screen (page 3-113) is the first to appear.

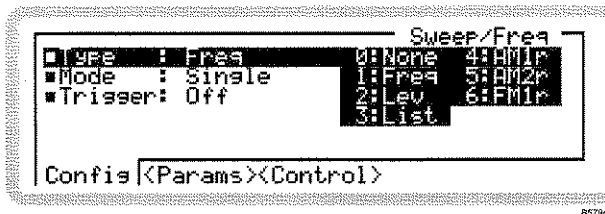

Fig. 3-78 Main sweep

Sweep menu — *<Config>*

From this menu, you can:

- Define the parameter (frequency, RF level, list, modulation rate (r)) that is to be swept
- Define whether the sweep is to be continuous or single-shot
- Define how the sweep is controlled.

■ Type

FREQ:MODE page 4-35

POW:MODE page 4-153

Use the numeric keypad to specify the parameter that is to be swept:

- | | | |
|---|-------------|---|
| 0 | <i>None</i> | sweep disabled |
| 1 | <i>Freq</i> | sweep the carrier frequency |
| 2 | <i>Lev</i> | sweep the RF level |
| 3 | <i>List</i> | sweep list table entries — see page 3-115 |

and then (if you have set up a modulation) a selection from:

- | | | |
|-----|---------------|--|
| 4-6 | <i>Am1/2r</i> | sweep AM1 or AM2 modulation rate |
| | <i>Fm1/2r</i> | sweep FM1 or FM2 modulation rate |
| | <i>Pm1/2r</i> | sweep Φ M1 or Φ M2 modulation rate |



■ Mode

SWE:OPER page 4-158

Use the numeric keypad to specify the sweep mode:

- | | | |
|---|-------------------|--|
| 0 | <i>Single</i> | Single sweep. The sweep steps from the start value to the stop value and halts, displaying the stop value. |
| 1 | <i>Continuous</i> | Continuous sweep. The sweep steps from the start value to the stop value, and then repeats. |

■ Trigger

SWE:TRIG page 4-159

Use the numeric keypad to specify the external trigger mode:

- | | | |
|---|-------------------|---|
| 0 | <i>Off</i> | External trigger is disabled. Control the triggering manually using the sweep control screen of Fig. 3-80. |
| 1 | <i>Start</i> | The trigger starts the sweep. At the end of the sweep the trigger latch resets, ready for the next input. During the sweep, trigger inputs are ignored. |
| 2 | <i>Start/Stop</i> | The first trigger starts the sweep, the next trigger pauses it. A further trigger causes the sweep to resume from the point at which it paused. The trigger latch resets after each start/stop. |
| 3 | <i>Step</i> | Each trigger increments the sweep by the size of the frequency/level step. The trigger latch resets after each step. |

The trigger input has a pull-up resistor, so a switch closure is treated as a trigger event.

Note: You can always control the sweep from the front panel, regardless of the trigger mode.

■ Slope

SWE:TRIG:SLOP page 4-159

This menu entry appears on the screen except when the selected trigger mode is Off.

Use the numeric keypad to specify the edge of the trigger pulse on which the sweep starts:

- | | | |
|---|-----------------|--|
| 0 | <i>Positive</i> | Trigger sweep on positive-going edge of trigger pulse. |
| 1 | <i>Negative</i> | Trigger sweep on negative-going edge of trigger pulse. |

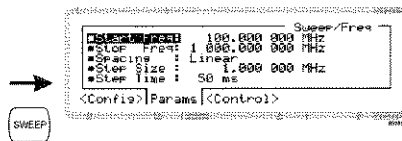

Sweep menu — <Params>

From this menu, you can:

- Define the start and stop frequencies/levels of the sweep
- Define whether the sweep is to be linear or logarithmic (logarithmic only for RF sweep)
- Define the size of step
- Define the step duration.

From the sweep menu of Fig. 3-78, touch <Params> or press **[TAB]** to display the parameter selection screen (Fig. 3-79).

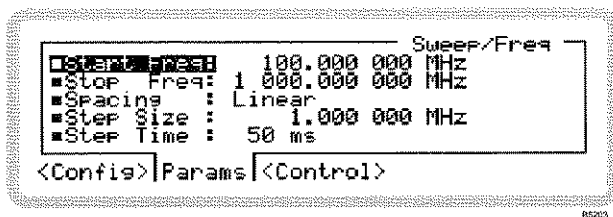

Fig. 3-79 Sweep parameter selection



■ Start Freq (Lev)

FREQ: SWE: STAR page 4-39
 POW: SWE: STAR page 4-155

Use the numeric keypad to specify the starting value for the sweep.

■ Stop Freq (Lev)

FREQ: SWE: STOP page 4-40
 POW: SWE: STOP page 4-156

Use the numeric keypad to specify the end value for the sweep.

■ Spacing

FREQ: SWE: SPAC page 4-38

Use the numeric keypad to specify linear or logarithmic spacing of the step points.

Note: *RF level sweep spacing is always logarithmic, with the step size specified in dB. For logarithmic frequency spacing, the value is expressed as a percentage and data entry is terminated with the **[MHz / % dB]** key.*

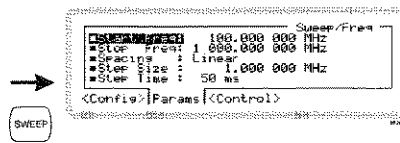

■ Step Size

FREQ: SWE: STEP page 4-39
POW: SWE: STEP page 4-155

Use the numeric keypad to specify the sweep step size.

For linear step spacing, terminate with the appropriate units key. For logarithmic spacing, the value is presented as a percentage.

■ Step Time

FREQ: SWE: DWEL page 4-37
POW: SWE: DWEL page 4-154

Use the numeric keypad to specify the duration of the step.



Sweep menu — <Control>

From this menu, you can start, stop and pause the sweep operation by touching ‘soft boxes’ on the screen. You can also alter the current frequency/level value.

From the sweep menu of Fig. 3-78, touch <Control> or press **<TAB>** to display the sweep control screen (Fig. 3-80).

Status messages show the current progress of the sweep: for example, *****Waiting for Trigger*****, *****Sweep Completed*****.

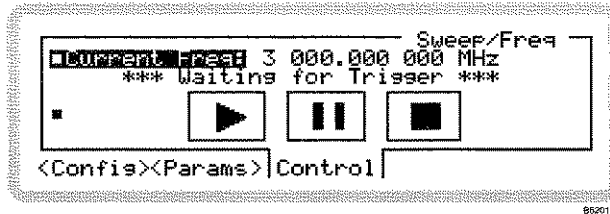

Fig. 3-80 Sweep control



■ **Current Freq (Lev)**

FREQ: SWE: MAN page 4-38
 POW: SWE: MAN page 4-154

This is highlighted whilst the sweep is inactive. Use the numeric keypad, control knob or the **x10** and **↑** keys to change the current frequency (level).



The soft boxes are always available for touch operation. However, to operate the sweep from the numeric keypad you need to press the **↓** navigation key, which displays the numbers in the corners of the soft boxes.





SWE: INIT page 4-158

Touch the *Play* soft box to start a sweep. If the sweep is set to *Continuous (Sweep Mode)*, page 3-110) the sweep continues indefinitely.



SWE: PAUS page 4-158

Touch the *Pause* soft box to stop the sweep. *Current Freq (Lev)* is highlighted, displaying the frequency/level step currently reached by the sweep. You can now use the  and  soft boxes to step the current frequency/level value backwards and forwards.

Touch  to continue the sweep.



SWE: AM: INT: SWE: MAN page 4-55

Whilst the sweep is paused, touch this soft box to decrease the current sweep frequency/level one step at a time. Step size is specified in the sweep parameter menu (page 3-112).

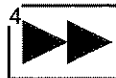

Whilst the sweep is paused, touch this soft box to increase the current sweep frequency/level one step at a time. Step size is specified in the sweep parameter menu (page 3-112).



SWE: ABOR page 4-158

Stop the sweep at any time by touching this soft box. The sweep halts and the frequency/level resets to its start value.

Summary of sweep operation and status messages

START	Starts the sweep. The status line changes from ***WAITING FOR TRIGGER*** to ***SWEEPING*** .
PAUSE	Stops the sweep at the current frequency/level step. The status message changes from ***SWEEPING*** to ***SWEEP PAUSED*** . You can change the frequency/level value reached.
CONTINUE	Continues the sweep. In continuous sweep mode, the sweep automatically repeats from the start frequency/level. At the end of a single sweep , the stop value is displayed and the status message changes from ***SWEEPING*** to ***SWEEP COMPLETED*** .
RESET	Discontinues the sweep and resets it to the start frequency/level. This selection is ignored when ***WAITING FOR TRIGGER*** .



List mode sweep

Note: This section applies only if you have list mode (Option 010) and an electronic attenuator (Option 003) fitted to your instrument.

Introduction

See page 3-109 for other sweep types.

Use list mode sweeping to sequentially set carrier level and frequency at a rate faster than is possible using frequency or level sweeps. In list mode, you pre-define up to 500 carrier frequencies and their associated levels in a table containing indexed entries of frequency and power. The instrument calculates the hardware settings needed to generate these values, and stores the settings. The settings can then be used to set the instrument's carrier frequency and level sequentially at a much increased speed compared to frequency or level sweeps.

The instrument also stores modulations and other settings that are current at the time that you calculate the list. When playing list entries, the instrument configures itself to reproduce the stored settings.

- Set up list mode sweeping on the main sweep screen (Fig. 3-81).



Fig. 3-81 Main sweep (list mode)

Phase noise optimization

Ensure that you set phase noise optimization to '<10 kHz' to ensure fast switching for list mode sweeping — see page 3-22.

List sweep menu — <Config>

From this menu, you can:

- Define the parameter that is to be swept — in this case, list mode
- Define whether the sweep is to be continuous or single-shot
- Define how the sweep is controlled.

■ Type

Using the numeric keypad, enter 3 to specify list mode.

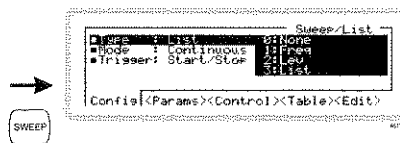

■ Mode

SOUR:LIST:OPER page 4-44

Use the numeric keypad to specify the sweep mode:

- | | | |
|---|-------------------|--|
| 0 | <i>Single</i> | Single sweep. The sweep steps from the start address to the stop address and halts, displaying the stop address. |
| 1 | <i>Continuous</i> | Continuous sweep. The sweep steps from the start address to the stop address, and then repeats. |

■ Trigger

SOUR:LIST:TRIG page 4-46

Use the numeric keypad to specify the external trigger mode:

- | | | |
|---|-------------------|---|
| 0 | <i>Off</i> | External trigger is disabled. Control the triggering manually using the sweep control screen of Fig. 3-83. |
| 1 | <i>Start</i> | The trigger starts the sweep. At the end of the sweep the trigger latch resets, ready for the next input. During the sweep, trigger inputs are ignored. |
| 2 | <i>Start/Stop</i> | The first trigger starts the sweep, the next trigger pauses it. A further trigger causes the sweep to resume from the address at which it paused. The trigger latch resets after each start/stop. |
| 3 | <i>Step</i> | Each trigger increments the sweep by one address. The trigger latch resets after each step. |

The trigger input has a pull-up resistor, so a switch closure is treated as a trigger event.

Note: You can always control the sweep from the front panel, regardless of the trigger mode.

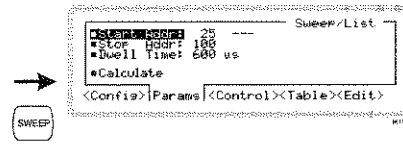

List sweep menu — <Params>

From this menu, you can:

- Define the start and stop list addresses of the sweep
- Define the dwell time (time spent at each entry in the list)
- Calculate and store the hardware set-up parameters for each list entry.

From the sweep menu of Fig. 3-81, touch <Params> or press <TAB> to display the parameter selection screen (Fig. 3-82).



Fig. 3-82 Sweep parameter selection (list mode)

Sweep

■ **Start Addr**

SOUR:LIST:STAR page 4-45

Use the numeric keypad to specify the start address for the list sweep.

■ **Stop Addr**

SOUR:LIST:STOP page 4-46

Use the numeric keypad to specify the stop address for the list sweep.

■ **Dwell Time**

SOUR:LIST:DWEL page 4-43

Use the numeric keypad to specify the dwell time; the time for which the output remains at each frequency/level in the list before moving on to the next address.

■ **Calculate**

SOUR:LIST:CALC page 4-42

Press ENTER to start the instrument calculating and storing the hardware settings for each list address. The instrument informs you when this is finished.

This list will now be used for list mode sweeps until another list is calculated. Any subsequent changes to list entries are not recognized until the list is re-calculated.

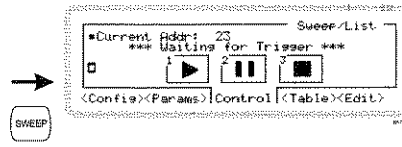

List sweep menu — <Control>

From this menu, you can start, stop and pause the sweep operation by touching ‘soft boxes’ on the screen. You can also alter the current address, when the sweep is paused.

From the sweep menu of Fig. 3-81, touch <Control> or press to display the list sweep control screen (Fig. 3-83).

Status messages show the current progress of the sweep: for example, ****Waiting for Trigger****, ****Sweep Completed****. ‘List settings are not valid’ means either that no entries have been made yet (<Edit> tab) or that the entries have not been calculated (<Params> tab).



Fig. 3-83 Sweep control (list mode)

■ Current Addr

This is highlighted whilst the sweep is inactive. Use the numeric keypad, control knob or the and keys to change the current address.



The soft boxes are always available for touch operation. However, to operate the sweep from the numeric keypad you need to press the navigation key, which displays the numbers in the corners of the soft boxes.



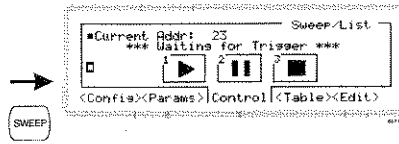

SOUR: LIST: INIT page 4-43

Touch the Play soft box to start a sweep. If the sweep is set to *Continuous (Mode, page 3-116)*, the sweep continues indefinitely.



SOUR:LIST:PAUS page 4-44

Touch the *Pause* soft box to stop the sweep. *Current Address* displays the list address reached by the sweep. You can now use the  and  soft boxes to step the address backwards and forwards.

Touch  to continue the sweep.



Whilst the sweep is paused, touch this soft box to decrease the current list address one step at a time.

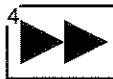

Whilst the sweep is paused, touch this soft box to increase the current list address one step at a time.



SOUR:LIST:ABOR page 4-42

Stop the sweep at any time by touching this soft box. The sweep halts and returns to the start address.

Summary of sweep operation and status messages

START	Starts the sweep. The status line changes from ***WAITING FOR TRIGGER*** to ***SWEEPING*** .
PAUSE	Stops the sweep at the current frequency/level step. The status message changes from ***SWEEPING*** to ***SWEEP PAUSED*** . You can change the list address reached.
CONTINUE	Continues the sweep. In continuous sweep mode, the sweep automatically repeats from the start address. At the end of a single sweep , the stop address is displayed and the status message changes from ***SWEEPING*** to ***SWEEP COMPLETED*** .
RESET	Discontinues the sweep and resets it to the start address. This selection is ignored when ***WAITING FOR TRIGGER*** .

Sweep

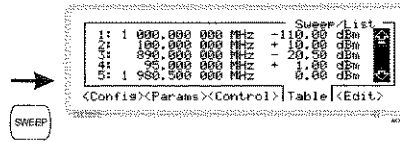

List sweep menu — <Table>

You can scroll through the list of frequency offset values by using the and keys.

Touch <Table> or press to display the table screen (Fig. 3-84).

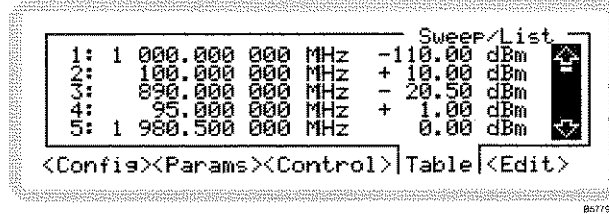
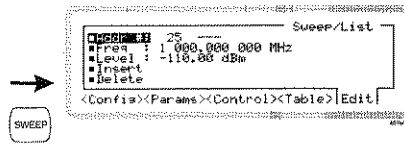

Fig. 3-84 List mode — table of entries



List mode — <Edit>

From this menu, you can change or delete the frequency and power entries shown in the table.

Touch <Edit> or press **<TAB>** to display the list editing screen (Fig. 3-54).

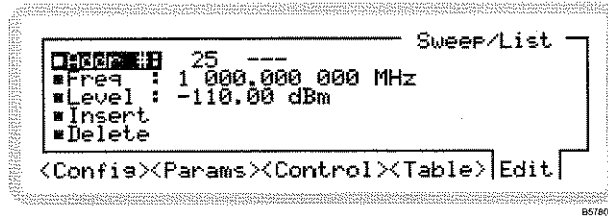

Fig. 3-85 List mode — edit list table

■ Addr

Use the numeric keypad or **$\times 10^0$** and **$\times 10^1$** keys to enter the correct address. As the value changes, the associated frequency and power level values change too. If there is no entry at that address, dashes are displayed.

■ Freq

SOUR:LIST:VAL page 4-47

Use the numeric keypad to change the frequency value.

■ Level

SOUR:LIST:VAL page 4-47

Use the numeric keypad to change the power level value.

■ Insert

SOUR:LIST:INS page 4-44

Press ENTER to insert an additional frequency and power level at the currently-indicated address. Following entries all shift down one address.

■ Delete

SOUR:LIST:DEL page 4-43

Press ENTER to delete the list entry at the currently-indicated address. Following entries all shift up one address.

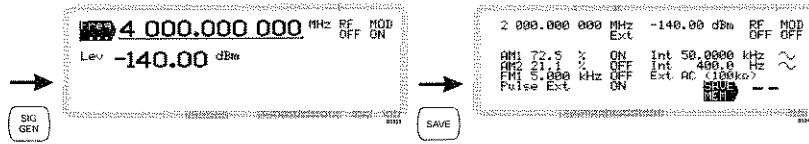

Memory

Save — saving configurations to memory

SYST:SETT:FULL:SAVE page 4-170

Press **SAVE** to see a complete summary of the current configuration of the instrument (for example, Fig. 3-86). You can save this configuration to memory. All the stores are non-volatile.

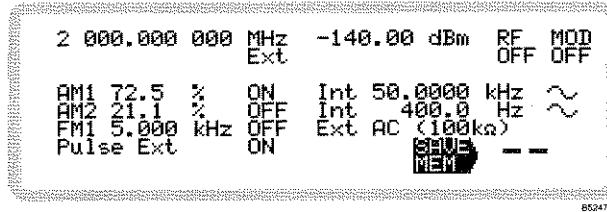
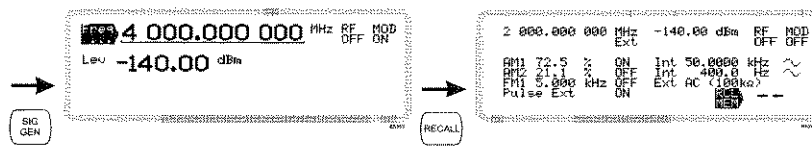

Fig. 3-86 Save

Enter the number of the memory store (0-99) to which you want to save the current instrument configuration and press ENTER to terminate.

Memory



Recall — retrieving stored settings from memory

SYST:SETT:FULL:REC page 4-170

Press **RECALL** to see a complete summary of the current configuration of the instrument (Fig. 3-86). From here, you can recall any previously stored instrument configuration, including factory pre-set defaults.

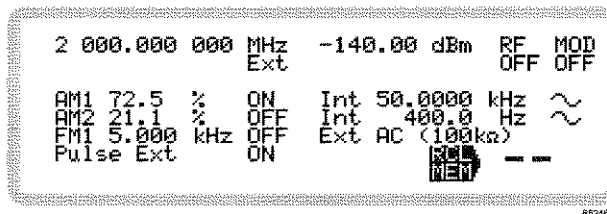

Fig. 3-87 Recall

Enter the number of the memory store (0–99), and press ENTER, to recall the chosen instrument configuration.

You can also use the control knob or **X10** and **+10** to step through the memory stores.

Factory default settings

Factory defaults settings are recalled differently to configurations that you have set yourself — see Table 3-2 on page 3-156.

Reverse power protection

Depending on the particular conditions, the reverse power protection circuit (RPP) may trip to protect the instrument when:

- External power is applied to the RF OUTPUT socket or
- No terminating load is attached to the RF OUTPUT socket and a high-level output is requested from the instrument.

Note that RPP is not available on the 3416 (6 GHz) instrument or when Option 001 is fitted.

The screen shown in Fig. 3-88 is displayed.

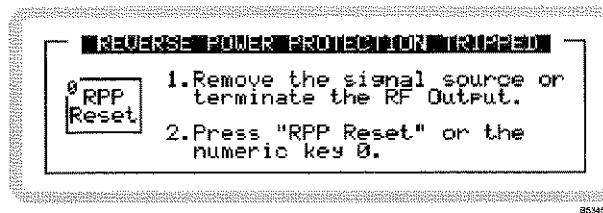

Fig. 3-88 RPP alert

Resetting the RPP

OUTP: PROT: CLE page 4:24

Remove the RF power source connected to the RF OUTPUT socket and touch the ⁰RPP Reset soft box as requested. The display returns to the menu in use at the time that the RPP tripped.

The attenuator and instrument RPP trip counts are incremented and stored. The current value for the total number of operating hours is also stored.

Tip: *If the instrument trips because of a reverse power flow from the UUT, disconnect the UUT. Before resetting the RPP, make sure that you reduce the RF output; otherwise the instrument could trip again immediately the RPP is reset (high power, no termination).*

Error status

Press  to see a screen (Fig. 3-89) that allows you to view the last 20 errors that have occurred, and clear the error list if necessary.

See page 3-157 for the listing of error messages.

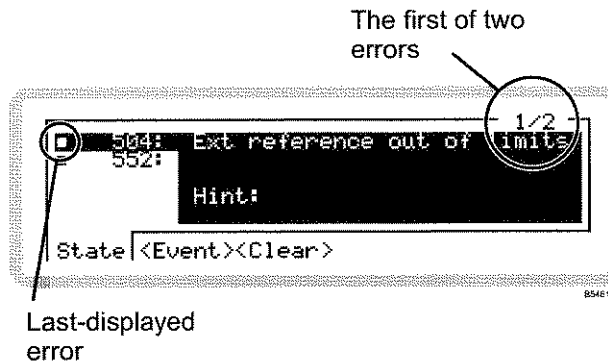



Fig. 3-89 Error status

<State>

Touch <State> to view state errors, which are generated because of an incorrect operating condition within the instrument. They are given numbers ≥ 500 . The latest error to be displayed is shown by a solid box (■).

- 1 Numbers at the top right of the screen show the current error displayed, and the total number of errors logged.
- 2 Move up and down the list using the  and  navigation keys.

<Event>

Touch **<Event>** to view event errors, which are generally caused when an entered parameter is outside its valid range, or when an invalid operation is requested. Event errors can often be cleared by selecting the correct function or by re-entering the parameter correctly. The last error to be displayed is shown by a solid box (■).

Move up and down the list using the **↓** and **↑** navigation keys.

Touch **<Clear>** to display a screen that allows you to clear all displayed event errors (state errors are not cleared) (Fig. 3-90).

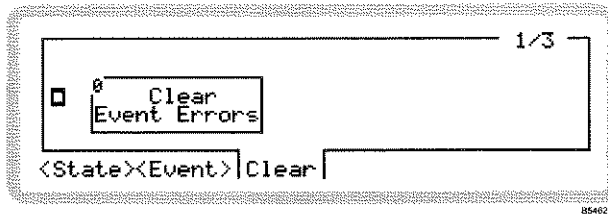

Fig. 3-90 Clear event errors

Touch the **0** **Clear Event Errors** soft box, or key **0**.

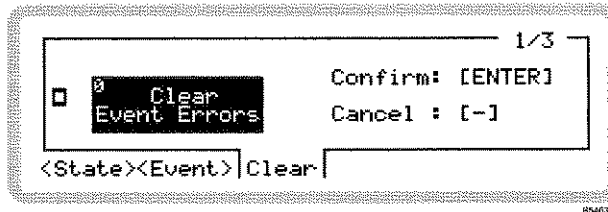

Fig. 3-91 Confirming clear event errors

- Cancel the request by pressing **↵**.
- Confirm by pressing **ENTER** — the event error list is cleared.

Remote operation

On receiving a valid command, the instrument switches automatically to remote operation. The display presents a complete summary of the current configuration of the instrument (for example, as in Fig. 3-92).

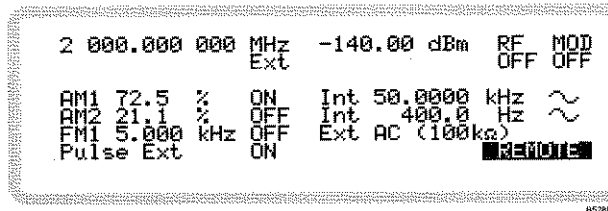
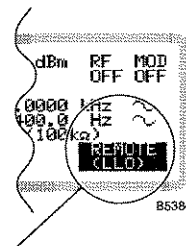



Fig. 3-92 Remote operation

Remote operation

Return to local operation

Press  to return the instrument to local operation.



Note: If the controller has asserted Local Lockout (LLO), the  key is disabled. The instrument can then only be returned to local operation by the controller.

UTILITIES

Press **UTIL** to see the main utilities screen (Fig. 3-93), from which you can set up all aspects of the instrument's configuration that are not directly concerned with making measurements¹.

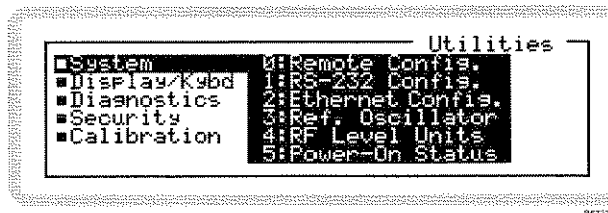

Fig. 3-93 Main utilities

What you can do from this screen:

- **System** remote/RS-232 configuration; SCPI/2023 language selection; GPIB address; Ethernet configuration; reference oscillator; RF level units; power-on status (page 3-132).
- **Display/keyboard** LCD adjustment; self-tests; screen blanking (page 3-144).
- **Diagnostics** instrument status, operating time and build configuration; attenuator type; latch access (page 3-147).
- **Security** locking/unlocking the instrument; clearing memory; locking the keyboard; choosing the reference oscillator (page 3-152).
- **Calibration** last adjustment dates and last complete check date for synthesizer/reference oscillator; modulation and RF level (page 3-155).

Storing settings

Unless indicated otherwise, each time that you change a utility setting it is stored in non-volatile memory.

¹ This screen appears after power-on or an instrument preset (for example, *RST). But if you have already set up any utility parameter since power-on or preset, the last function selected appears.



■ System

Get to the system utilities by scrolling on the *Utilities* main screen (Fig. 3-93).

Select a system utility using the numeric keypad:

- | | | |
|---|------------------------|---------------|
| 0 | <i>Remote Config.</i> | (this page) |
| 1 | <i>RS-232 Config.</i> | (page 3-134) |
| 2 | <i>LAN Config.</i> | (page 3-136) |
| 3 | <i>Ref. Oscillator</i> | (page 3-138) |
| 4 | <i>RF Level Units</i> | (page 3-141) |
| 5 | <i>Power-On Status</i> | (page 3-142). |

■ System: Remote Config.

Press 0 on the numeric keypad to see the remote configuration screen (Fig. 3-94).

From this screen you can:

- Select the type of interface: GPIB, RS-232 or LAN
- Select the programming language: SCPI or 2023
- Select the instrument's GPIB address.

Remote config. menu — <Interface>

SYST:COMM:REM page 4-165

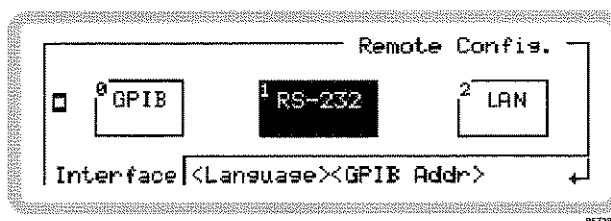

Fig. 3-94 Remote configuration — interface

Touch the appropriate soft box or press the equivalent numeric key to change the type of interface.



Remote config. menu — <Language>

SYST:LANG page 4-169

Touch <Language> or press **<TAB>** to display the language configuration screen (Fig. 3-95).

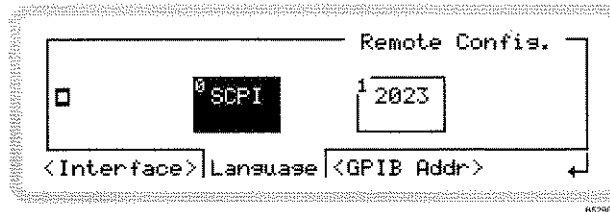

Fig. 3-95 Remote configuration — language

Touch the appropriate soft box or equivalent numeric key to select which command set is used:

- SCPI commands conform where possible to the SCPI standard
- 2023 supports the 2023 Series command set, including 2023 Series status reporting and error message handling.

Remote config. menu — <GPIB Addr>

SYST:COMM:GPIB:ADDR page 4-164

Touch <GPIB Addr> or press **<TAB>** to display the GPIB address screen (Fig. 3-96).



Fig. 3-96 Remote configuration — GPIB address

Set the new GPIB address using the numeric keypad.



■ System: RS-232 Config.

From this screen, you can set up RS-232 communication parameters. The RS-232 port is used for downloading upgrades to the instrument's firmware.

Press **1** on the numeric keypad to see the RS-232 configuration screen (Fig. 3-97).

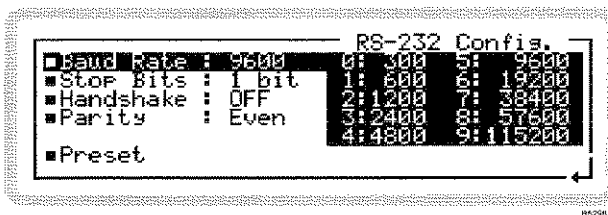

Fig. 3-97 RS-232 configuration

■ Baud Rate

SYST:COMM:SER:BAUD page 4-165

Use the numeric keypad to specify the baud rate, in the range 300 to 115200 bit/s.

0	300 bit/s	5	9600 bit/s
1	600 bit/s	6	19200 bit/s
2	1200 bit/s	7	38400 bit/s
3	2400 bit/s	8	57600 bit/s
4	4800 bit/s	9	115200 bit/s

■ Stop Bits

SYST:COMM:SER:SBIT page 4-167

Use the numeric keypad to specify the number of stop bits:

0	1 bit
1	2 bits

■ Handshake

SYST:COMM:SER:CONT:HAND page 4-166

Use the numeric keypad to set hardware or software handshaking:

0	OFF
1	H/W
2	S/W
3	BOTH



■ Parity

SYST: COMM: SER: PAR page 4-166

Use the numeric keypad to specify the parity:

- 0 None
- 1 Even
- 2 Odd

■ Preset

Press ENTER to restore the RS-232 settings to the default values of IEEE 1174.

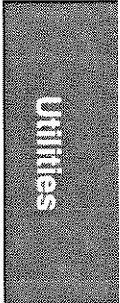



■System: LAN Config.

From this screen, you can set up LAN (Local Area Network) communication parameters. The LAN port can be used for remote control using VXI-11 Instrument protocol and for downloading upgrades to the instrument's firmware.

A Telnet interface is available for investigation and debugging.

Press **2** on the numeric keypad to see the LAN configuration screen (Fig. 3-98).

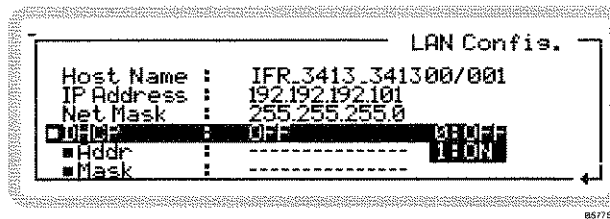

Fig. 3-98 LAN configuration

Host Name

`SYST:COMM:ETH:HNAM` page 4-164

You can set the Host Name that appears in DHCP server logs using the remote command.

■IP Address

When DHCP is on, this field shows the IP address received from the DHCP host.

An address of 0.0.0.0 means that there has been no reply from the DHCP host.

■Net Mask

When DHCP is on, this field shows the net mask address received from the DHCP host.

An address of 0.0.0.0 means that there has been no reply from the DHCP host.

■DHCP

`SYST:COMM:ETH:AUTO` page 4-163

Enables or disables Dynamic Host Configuration Protocol (DHCP), which assigns a TCP/IP client address to the instrument automatically.

Use the numeric keypad to turn DHCP on or off:

0 Off

1 On

■Addr

`SYST:COMM:ETH:ADDR` page 4-163

Use the numeric keypad to enter the IP address when DHCP is off.



▪ **Mask**

SYST:COMM:ETH:ADDR page 4-163

Use the numeric keypad to enter the net mask address when DHCP is off.

Utilities



■System: Ref. Oscillator

From this screen, you can select a 10 MHz output to provide a standard for associated equipment. You can also define a standard (external or internal) for use by the instrument. When an external standard is selected, the internal OCXO locks to it, and you can choose between **direct** and **indirect**:

- Direct: the internal standard for the instrument’s RF section is provided directly from the external standard
- Indirect: the internal standard is provided from the OCXO, locked to the external standard.

If the instrument is unlocked (refer to page 3-152), you can manually adjust the reference oscillator’s tuning value and save this to a non-volatile store.

Press **2** on the numeric keypad. If the instrument is locked, you see the internal reference oscillator screen shown in Fig. 3-99. If the instrument is unlocked, an additional soft tab (<Adjust>) is visible.

Ref. Oscillator menu — <Int Ref>

ROSC: SOUR page 4-29

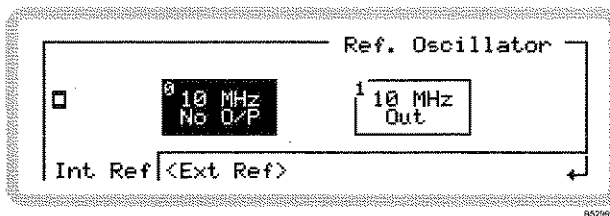

Fig. 3-99 Internal reference oscillator

Touch the appropriate soft box or equivalent numeric key to switch the 10 MHz internal reference output on or off. The signal is output at the FREQ STD IN/OUT socket.

If an external reference is selected, neither soft box is highlighted.

Ref. Oscillator menu — <Ext Ref>

Touch <Ext Ref> or press **<TAB>** to display the external reference selection screen (Fig. 3-100).

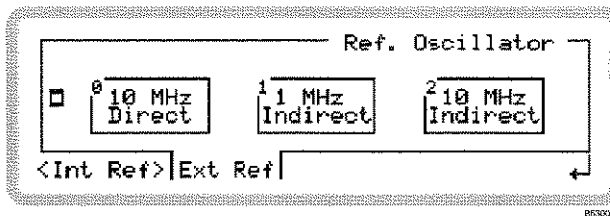

Fig. 3-100 External reference oscillator (instrument locked)



Touch the appropriate soft box or equivalent numeric key to select an external source type.

Connect the signal to the FREQ STD IN/OUT socket.

Tip: You should select Direct if the external standard has significantly lower phase noise than that fitted in the instrument.

Select Indirect if you merely want a more accurate frequency standard.

Adjusting the tuning offset

If the instrument is unlocked*, the additional <Adjust> soft tab appears (Fig. 3-101).

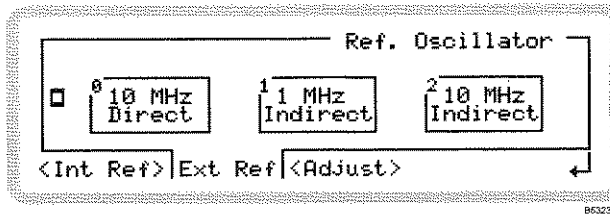

Fig. 3-101 External reference oscillator (instrument unlocked)

Touch <Adjust> or press <TAB> to display the tuning offset screen (Fig. 3-102).

* The tuning offset value is protected to the 'user password' level and the instrument needs to be unlocked before the tuning offset can be changed — see page 3-152.

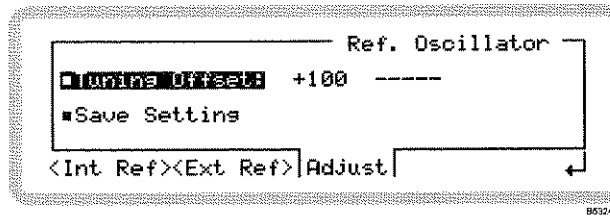

Fig. 3-102 Reference oscillator tuning offset

■ Tuning Offset

ROSC:INT:ADJ page 4-28

The current tuning offset is displayed. This represents the deviation from the reference tuning value established during calibration.

Change it using the numeric keypad, control knob or $\times 10$ and $\div 10$ keys.



■ Save Setting

ROSC : INP : ADJ : SAV page 4-28

Press ENTER to save the current tuning offset for use at the next power-on.

This new value does not overwrite the tuning value set during calibration.



■System: RF Level Units

From this screen, you can:

- Define the type of dB units for RF level
- Define whether output voltage is shown as EMF or PD.

Press 3 on the numeric keypad to see the RF level dB units screen (Fig. 3-103).

Ref. Level Units menu — <dB rel>

UNIT: POW page 4-172

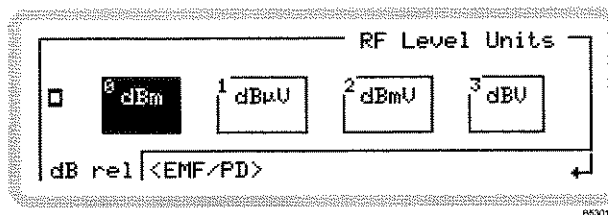

Fig. 3-103 RF level dB units

Touch the appropriate soft box or equivalent numeric key to select dB units.

Ref. Level Units menu — <EMF/PD>

UNIT: VTYP page 4-172

Touch <EMF/PD> or press <TAB> to display the output voltage selection screen (Fig. 3-104).

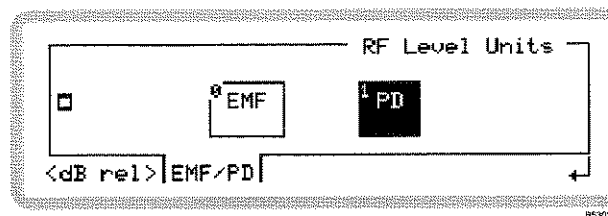

Fig. 3-104 RF level EMF/PD

Touch the appropriate soft box or equivalent numeric key to select output voltage source type.

- EMF: voltage generated into an open circuit
- PD: voltage generated across a 50 Ω load.

Utilities



■System: Power-On Status

From this screen, you can:

- Define whether the instrument starts up from the factory default or a memory setting
- Define which memory location is used
- Force the instrument to adopt its preset hardware configuration (currently the same as factory default).

Press 4 on the numeric keypad to see the power-on status screen (Fig. 3-105).

Power-On Status menu — <Mode>

SYST: PON: TYPE page 4-170

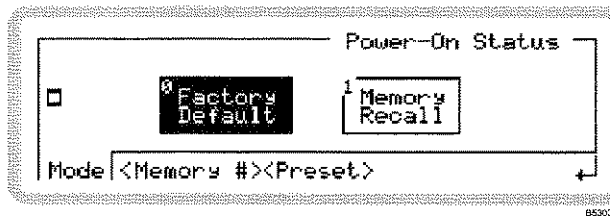

Fig. 3-105 Power-on mode

Touch the appropriate soft box or equivalent numeric key to define whether the instrument:

- Starts up with the factory default settings (page 3-156)
- Starts up from the memory location defined by <Memory #> below.

Power-On Status menu — <Memory #>

SYST: PON: MEM page 4-169

Touch <Memory #> or press **<TAB>** to display the memory recall screen (Fig. 3-106).

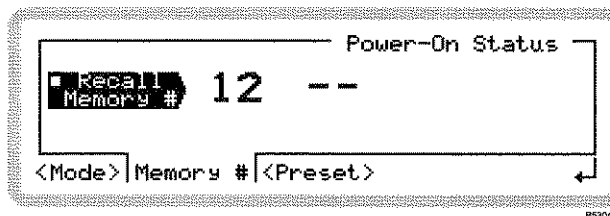

Fig. 3-106 Power-on memory recall

Enter the required memory location using the numeric keypad and press ENTER to terminate. This location is used to set up the instrument at power-on if *Memory Recall* is selected above.



Power-On Status menu — <Preset>

SYST: PRES page 4-170

This operation forces the instrument immediately to its factory default configuration, without altering its usual power-on configuration.

Touch <Preset> or press to display the preset power-on screen (Fig. 3-107).

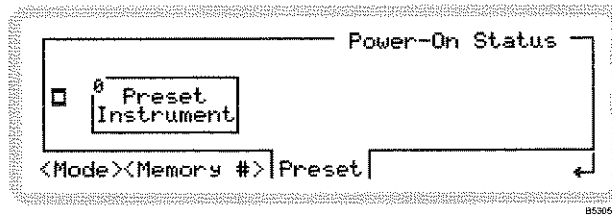

Fig. 3-107 Power-on preset

Touch the soft box or key 0 to request an instrument preset (Fig. 3-108).

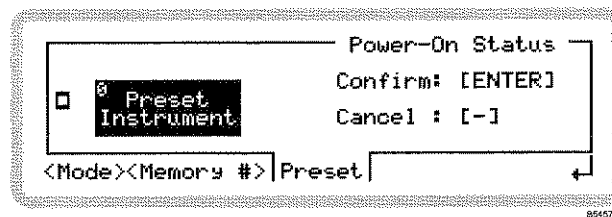

Fig. 3-108 Confirming power-on preset

- Cancel the request by pressing .
- Confirm by pressing ENTER — the instrument changes immediately to its factory default configuration (page 3-156).

Note that at the next power-on, the mode in which the instrument starts up is still determined by the Mode setting on page 3-142.

Utilities



■ Display/Kybd

Get to the display and keyboard utilities by scrolling on the *Utilities* main screen (Fig. 3-93).

Select a display/keyboard utility using the numeric keypad:

- | | | |
|---|--------------------|--------------|
| 0 | <i>LCD Adjust</i> | (this page) |
| 1 | <i>Touch Panel</i> | (page 3-145) |
| 2 | <i>Blanking</i> | (page 3-145) |

With these utilities, you can:

- Set the LCD's contrast
- Size and calibrate the touch screen
- Set up display blanking.

■ Display/Kybd: LCD Adjust

Press **0** on the numeric keypad to see the LCD contrast adjustment screen (Fig. 3-109).

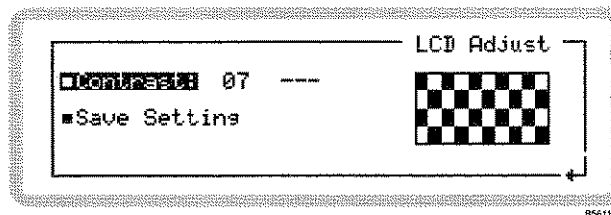

Fig. 3-109 LCD adjustment

■ Contrast

The current contrast setting is displayed. Change it using the numeric keypad, control knob or

$\left(\begin{smallmatrix} \times 10 \\ \downarrow \end{smallmatrix}\right)$ and $\left(\begin{smallmatrix} +10 \\ \uparrow \end{smallmatrix}\right)$ keys.

■ Save Setting

DISP:CONT page 4-188

Press ENTER to save the current contrast setting for use at the next power-on.



■ Display/Kybd: Touch Panel

Press 1 on the numeric keypad to see the first touch calibration screens (Fig. 3-110).

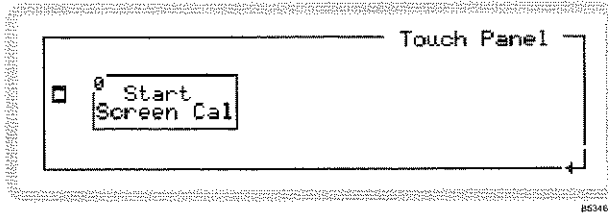

Fig. 3-110 Screen calibration, first screen

This utility recalibrates and checks the usable area of the touch screen. Follow the instructions that appear: you are asked to establish the limits of the touch area and then check the result by observing that the instrument accurately locates a random contact point. If this fails, you are given the opportunity to try again.

You may need to touch the screen for a little longer than usual before the instrument responds.

■ Display: Blanking

DISP:ANN page 4-186

From this screen, you can instruct the instrument to display only asterisks (*) instead of digits (for reasons of security or sensitivity) in any of the following fields:

- Frequency
- RF level
- Modulation.

Press 2 on the numeric keypad to see the blanking screen (Fig. 3-111).

Blanking menu — <Freq>

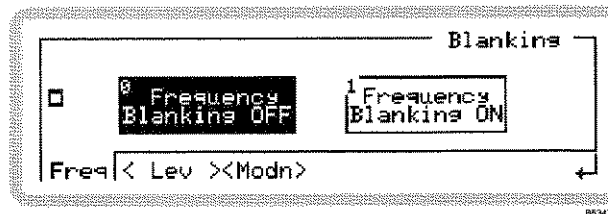



Fig. 3-111 Blanking menu (frequency)

Utilities



Touch the appropriate soft box. Select frequency blanking *ON* and the main screen (press ) looks like Fig. 3-112.

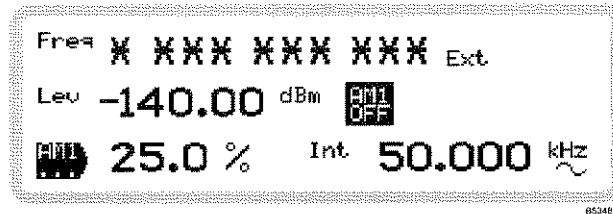

Fig. 3-112 Main screen with frequency field blanked

Blanking menu — <Lev> and <Modn>

Blank the level and modulation fields in the same way as for frequency. All modulation parameters appearing on the display are replaced by asterisks.



■ Diagnostics

Get to the diagnostic utilities by scrolling on the *Utilities* main screen (Fig. 3-93).

Select a diagnostic utility using the numeric keypad:

- 0 *Inst. Status* (this page)
- 1 *Operating Time* (page 3-149)
- 2 *Build Config.* (page 3-150)
- 3 *Latch Access* (page 3-150)
- 4 *Attenuator* (page 3-150)

■ Diagnostics: Inst. Status

Press 0 on the numeric keypad to see the instrument status screen (Fig. 3-113).

From this screen, you can:

- View software and hardware status
- View which options are fitted
- View applicable patents.

Inst Status menu — <S/W>

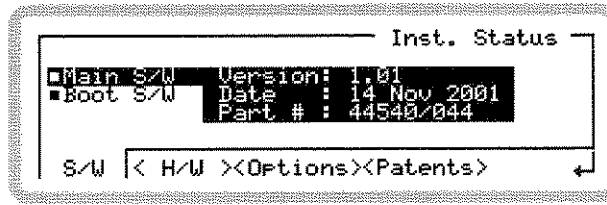

Fig. 3-113 Software status

You can view details of the instrument's software status:

- version number
- version date
- version part number.





Inst Status menu — <H/W>

Touch <H/W> or press to display the hardware status screen (Fig. 3-114).

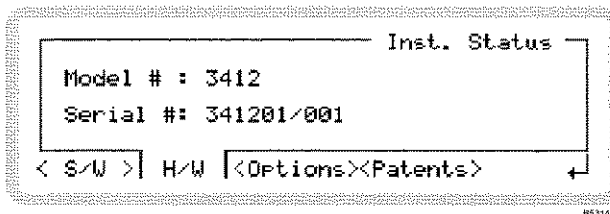

Fig. 3-114 Hardware status

You can view details of the instrument's hardware status:

- model number
- serial number.

Inst Status menu — <Options>

Touch <Options> or press to display the options screen (Fig. 3-115).

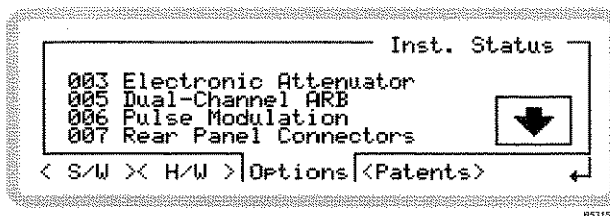

Fig. 3-115 Options

This shows which options (if any) are fitted to the instrument. If further options are fitted, a soft box is displayed. Touch this, or press , to view these options.

Go back by touching the soft box or press .



Inst Status menu — <Patents>

Touch <Patents> or press **<TAB>** to display the patents screen (Fig. 3-116).

You can view patents applicable to the instrument

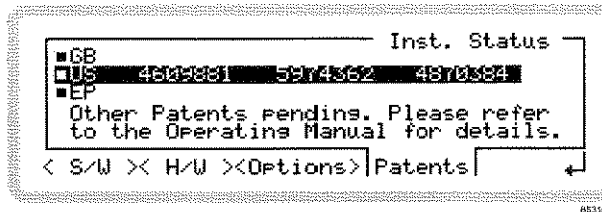

Fig. 3-116 Patents

- GB
 - US
 - EP
- } View British/US/European patents.

■Diagnostics: Operating Time

DIAG: INF: ETIM? page 4-180

Press **1** on the numeric keypad to see the instrument operating time screen (Fig. 3-113).

This screen shows the elapsed operating time since this value was last reset¹.

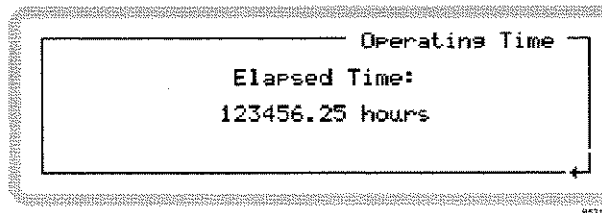

Fig. 3-117 Elapsed operating time

Utilities

¹ Refer to the Maintenance Manual for information on how to reset the elapsed time counter.



■Diagnostics: Build Config.

From this screen, you can view the part number, serial number and build status for major sub-assemblies within the instrument.

Press 2 on the numeric keypad to see the build configuration screen (Fig. 3-118).

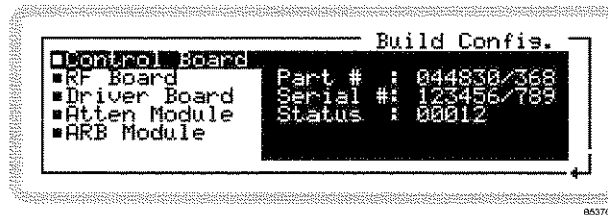

Fig. 3-118 Build configuration

■Diagnostics: Latch Access

From this screen, you can view and change the data that has been sent to latches within the instrument. This is a useful diagnostic aid during fault identification. It is protected by the user password.

For further information, refer to the Maintenance Manual.

■Diagnostics: Attenuator (not available if Option 001 is fitted)

From this screen, you can:

- View the type, part number and serial number of the attenuator
- View the number of times the RPP has tripped.
- View the attenuator pad values and switch the pads in or out.

Press 4 on the numeric keypad to see the attenuator status screen (Fig. 3-119).

Attenuator menu — <Details>

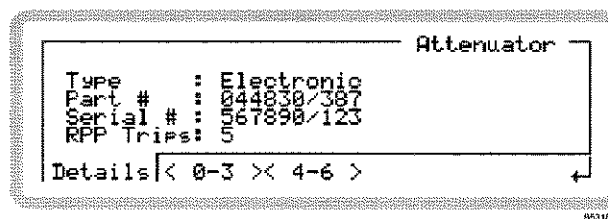
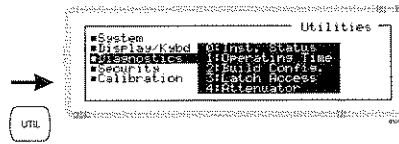

Fig. 3-119 Attenuator details



Attenuator menu — <0-3>

Touch <0-3> or press to display the screen that shows details of attenuator pads 0 to 3 (Fig. 3-120).

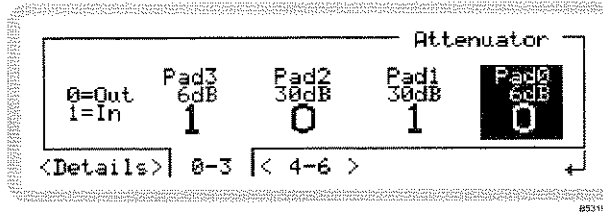

Fig. 3-120 Attenuator pads 0-3

Pads 0 to 3 are shown, each with its attenuation value and hardware (in/out) setting. The selected bit is highlighted.

- Select bits by pressing the (move right) and (move left) keys
- Press 0 or 1 on the numeric keypad to set the pad value.

Attenuator menu — <4-6>

Touch <4-6> or press to display the screen that shows details of attenuator pads 4 to 6 (Fig. 3-121).

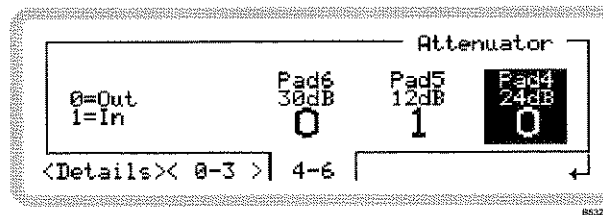

Fig. 3-121 Attenuator pads 4-6

Operation is the same as for pads 0 to 3.



■ Security

A user password allows you to access protected utilities (see box).

Get to the security utilities by scrolling on the *Utilities* main screen (Fig. 3-93).

Select a security utility using the numeric keypad:

- 0 *Lock/Unlock* the whole instrument (this page)
- 1 *Memory Clear* (page 3-153)
- 2 *Kybd Lock* (page 3-154)

Protected by the user password

- Keyboard locking
- Memory clear
- Reference oscillator adjustment

Note: This section deals with the **user password**. A more secure password, which allows additional diagnostic and hardware settings to be made, is reserved for administrators. Refer to the *Maintenance Manual* for details of the **administrator password**.

■ Security: Lock/Unlock

Press 0 on the numeric keypad to see the instrument's protection utility screen (Fig. 3-122).

From this screen, you can use the user password to lock and unlock the instrument in order to make adjustments to its set-up.

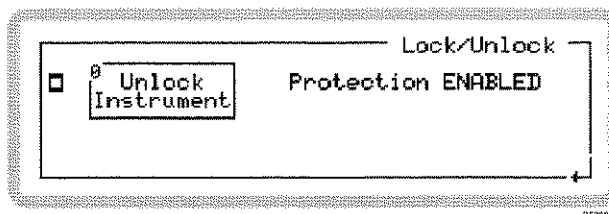
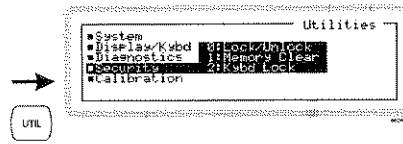

Fig. 3-122 Protection utility

- 1 Touch the soft box or key 0.
- 2 Enter the six-digit user password (see box). An asterisk appears as each digit is entered. Press ENTER to finish. The display shows *Protection DISABLED*.
- 3 You can now access the keyboard-locking facility, clear the memory and adjust the reference oscillator.

Instrument type	User password
3412	341201
3413	341301
3414	341401
3416	341601

- 4 Touch the soft box or key 0 again to re-establish protection for the instrument.



■ Security: Memory Clear

SYST:SETT:FULL:CLE:ALL page 4-170

From this screen, you can erase the contents of all the user memory stores in one operation.

Press 1 on the numeric keypad to see the memory clear screen (instrument protection disabled) (Fig. 3-123). If the screen indicates that instrument protection is enabled, first remove the lock on the instrument (page 3-152).

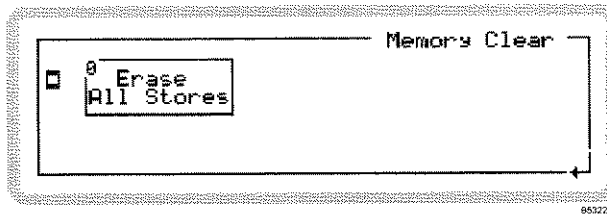



Fig. 3-123 Memory clear

Touch the  soft box or key 0 to erase all the memory stores (Fig. 3-124).

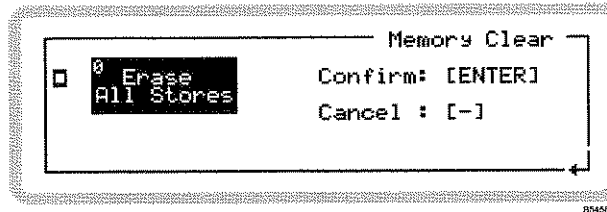



Fig. 3-124 Confirming memory clear

- If you want to cancel the request, press ; otherwise:
- Confirm by pressing ENTER — the stores are erased and a confirmation message appears.

Utilities



■Security: Kybd Lock

SYST:KLOC page 4-168

From this screen, you can lock or unlock most of the keys and the control knob.

Press 2 on the numeric keypad to see the keyboard locking screen (instrument protection disabled) (Fig. 3-125). If the screen indicates that instrument protection is enabled, first remove the lock on the instrument (page 3-152).

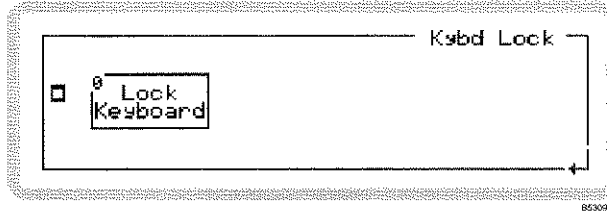

Fig. 3-125 Keyboard locking

Touch the Lock Keyboard soft box or key 0 to lock the keyboard (Fig. 3-126).

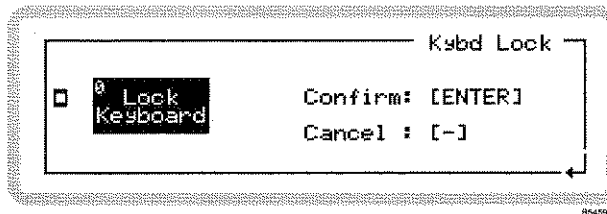

Fig. 3-126 Confirming keyboard locking

- If you want to cancel the request, press ; otherwise:
- Confirm by pressing ENTER — the keyboard is locked and the display changes to show a summary of the instrument's set-up (Fig. 3-127). A 'key' symbol shows that the keyboard is locked. All controls (apart from the standby switch and the key) are disabled.

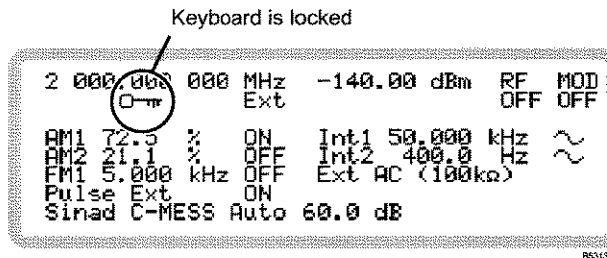
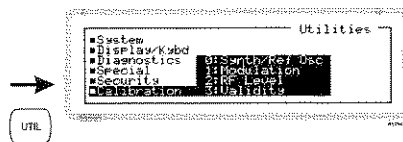

Fig. 3-127 Locked keyboard

Unlock the keyboard by entering the user password (for example, 341201) on the numeric keypad, and press ENTER to terminate.



■ Calibration

You can view the last date on which various parameters were adjusted, and also an overall 'last complete check' date.

Get to the calibration utilities by scrolling on the *Utilities* main screen (Fig. 3-93).

Select a calibration utility using the numeric keypad:

- 0** *Synth/Ref Osc* display calibration dates (see box)
- 1** *Modulation* display calibration dates (see box)
- 2** *RF Level* display calibration dates (see box)
- 3** *Freq Extension* display calibration dates (see box)
(3416 only)
- 3/4** *Validity* display the date of the last complete check.

View last calibration dates for the following:

Synth/Ref Osc

- VTF core presteer
- PLO presteer
- Reference oscillator

Modulation

- Modulation oscillator
- FM/φM
- AM
- External level monitor
- IQ path offset
- IQ overlap
- IQ modulator
- ARB calibration

RF Level

- Level reference offset
- Level reference
- Offset null
- Tray
- Fine ALC DAC
- System
- Tray error
- ALC characterization
- Mode switch/ALC
- Level modulator
- Burst modulator (fine)
- Burst modulator (frequency)
- Attenuator calibration
- Pulse modulation

Freq Extension (3416 only)

- Offset null
- Tray
- System
- Tray error
- ALC characterization
- Level modulator/ALC
- Burst modulator (fine)
- Burst modulator (freq)
- IQ modulator

Validity

- Last complete check

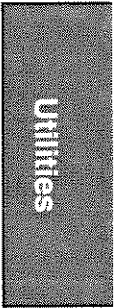

Default settings

The instrument reverts to the factory default settings:

- At power-on (unless you have stored a different power-on memory location — see page 3-142)
- After a *Preset Instrument* operation (page 3-143)
- After the ***RST** command.

Table 3-2 Default settings

Carrier frequency: Step :	(Maximum available) 2 GHz/3 GHz/4 GHz/6 GHz 1 kHz
RF level: Step:	-140 dBm (0 dB for Option 001 no attenuator) 1 dB Status: OFF
Modulation mode:	Internal FM, modulation disabled
Modulations:	FM1: Deviation: 0 Hz, ON Internal source, frequency: 1 kHz, sine FM2: Deviation: 0 Hz, ON Internal source, frequency: 400 Hz, sine Φ M1: Deviation: 0 rad, ON Internal source, frequency: 1 kHz, sine Φ M2: Deviation: 0 rad, ON Internal source, frequency: 400 Hz, sine AM1: Deviation: 0%, ON Internal source, frequency: 1 kHz, sine AM2: Deviation: 0%, ON Internal source, frequency: 400 Hz, sine Pulse: ON
External source:	AC coupled, 50 Ω
MOD ON/OFF	ON
SOURCE ON/OFF	ON for all modulation parameters
Modulation steps:	Δ FM 1 kHz, $\Delta\Phi$ M 0.1 rad, Δ AM 1%
Mod frequency steps:	10 Hz
Carrier sweep:	
Freq mode:	Fixed
Mode:	Single sweep
Type:	Linear
Ext trigger:	Off
Start:	250 kHz
Stop:	(Maximum available)
Step size:	1 kHz
Time:	50 ms

Error messages

0	No error
---	----------

Query errors

Occur when an attempt is made to read data from the output queue when no output is present or pending, or when data has been lost.

-430	Query DEADLOCKED
-420	Query UNTERMINATED
-410	Query INTERRUPTED
-403	Stream error
-402	Stream disconnect
-401	Device clear
-400	Query error

Command errors

Occur when a message received from the controller does not comply with the IEEE 488.2 standard, or an unrecognized header is received.

-178	Expression data not allowed
-168	Block data not allowed
-161	Invalid block data
-158	String data not allowed
-151	Invalid string data
-148	Character data not allowed
-144	Character data too long
-141	Invalid character data
-140	Character data error
-138	Suffix not allowed
-134	Suffix too long
-131	Invalid suffix
-128	Numeric data not allowed
-124	Too many digits
-123	Exponent too large
-121	Invalid character in number
-120	Numeric data error
-113	Undefined header
-112	Program mnemonic too long
-111	Header separator error
-110	Command header error
-109	Missing parameter

-108	Parameter not allowed
-105	GET not allowed
-104	Data type error
-103	Invalid separator
-102	Syntax error
-101	Invalid character
-100	Command error
172	1174 emulation code error

Execution errors

Occur when a received parameter is outside its allowed range or inconsistent with the instrument's capabilities, or when the instrument does not execute a valid program message properly due to some device condition.

-257	Filename error
-256	File not found
-254	Media (memory) full
-253	Corrupt media (memory)
-223	Too much data
-222	Data out of range
-221	Settings conflict
-200	Execution error
100	Carrier limit
101	Carrier step limit
102	RF level limit
103	RF level step limit
104	Invalid modulation mode
105	AM1 limit
106	AM2 limit
107	AM1 step limit
108	AM2 step limit
109	FM1 limit
110	FM2 limit
111	FM1 step limit
112	FM2 step limit
113	Φ 1 limit
114	Φ 2 limit
115	Φ 1 step limit
116	Φ 2 step limit
118	AM1 frequency limit
119	AM1 frequency step limit
120	AM2 frequency limit
121	AM2 frequency step limit
122	FM1 frequency limit
123	FM1 frequency step limit

124	FM2 frequency limit
125	FM2 frequency step limit
126	Φ M1 frequency limit
127	Φ M1 frequency step limit
128	Φ M2 frequency limit
129	Φ M2 frequency step limit
134	Sweep time limit
135	Sweep mode disabled
136	Carrier phase limit
156	RF offset limit
168	Swept value limited by start/stop
169	Manual sweep setting not allowed
170	Log step limit
171	Logarithmic sweep start/stop can not be zero
175	Carrier phase step limit
176	Modulation phase difference limit
177	Rise time limit
178	Fall time limit
179	Rise time limited by profile
180	Fall time limited by profile
181	Burst offset limit
182	Duration delta limit
183	Burst atten limit
184	Trigger interval limit
185	Trigger interval limited by h/w latency
186	Absolute trigger interval limit
187	ARB tuning offset limit
188	ARB RMS offset limit
222	Cal bands not defined
300	Invalid cal store format
301	Invalid settings store
302	ARB waveform format error
303	ARB internal error
304	ARB checksum error
305	ARB verification error
306	Options store error
307	Inconsistent latch info
310	Option not present
406	Invalid ARB sector
514	RF level limited by user limit
515	FM1 limited by freq
550	RF level limited by AM
551	AM2 limited by AM1
552	FM2 limited by carrier/FM1
553	Φ M2 limited by Φ M1

Device errors

Occur when a device operation does not complete properly, possibly due to an abnormal hardware or firmware condition.

-350	Queue overflow
-321	Out of memory
-310	System error
-300	Device specific error
-1	Unknown error
308	Invalid store catalog detected
309	Store checksum failure
400	No cal data on EEPROM
401	DSP is out of space for cal data
402	ARB not present
403	ARB booted from backup image
404	ARB control failure
405	ARB file system not initialized
407	Device initialization error
408	Device calibration error
496	DSP handshaking timed out
497	DSP received an invalid message header
498	DSP received an invalid message body
499	DSP sent an invalid message header
500	RPP tripped
501	Fractional-N loop low
502	Fractional-N loop high
503	Ext standard missing
504	Ext standard too low
505	Ext standard too high
506	800 MHz PLO low
507	800 MHz PLO out of limits
509	Output unlevelled
511	ALC too high
512	ALC too low
517	Ext AM out of limits
518	Ext FM out of limits
519	Ext Φ M out of limits
520	ARB PLL out of limits
521	OCXO out of limits
522	Power supply failure
523	ARB DACs not in sync

2023 emulation

This instrument can be configured easily (page 3-133) to respond to many commands originally written for 2023 Series AM/FM signal generators (2023, 2024, 2023A, 2023B and 2025). The following is a list of 2023 Series commands that are emulated by 3410 Series instruments. For details of the commands, refer to the appropriate operating manual: part no. 46882/225 for 2023 and 2024; part no. 46882/373 for 2023A, 2023B and 2025.

Note: *Status reporting is returned in 2023 format.*

Common commands and * commands are as standard 2023 Series.

*RST resets the instrument to 2023 Series defaults.

BLANK	AM:MODF:Up
CONTRAST	AM:MODF[:VALUE]
ELAPSED?	AM:MODF:Xfer
ELAPSED:RESET	AM:OFF
ERASE:ALL	AM:ON
ERROR?	AM:Retn
FSTD	AM:Up
GPIB	AM:Xfer
KLOCK	
KUNLOCK	AM2[:DEPTH]
OPER?	AM2:Dn
POWUP:MEM	AM2:EXTAC
POWUP:MODE	AM2:EXTDC
RCL?	AM2:Inc
RCL:DN	AM2:INT
RCL:MEM	AM2:MODF:Dn
RCL:UP	AM2:MODF:Inc
	AM2:MODF:PHASE
AM[:DEPTH]	AM2:MODF:Retn
AM:Dn	AM2:MODF:SIN
AM:EXTAC	AM2:MODF:SQR
AM:EXTDC	AM2:MODF:TRI
AM:Inc	AM2:MODF:Up
AM:INT	AM2:MODF[:VALUE]
AM:MODF:Dn	AM2:MODF:Xfer
AM:MODF:Inc	AM2:OFF
AM:MODF:PHASE	AM2:ON
AM:MODF:Retn	AM2:Retn
AM:MODF:SIN	AM2:Up
AM:MODF:SQR	AM2:Xfer
AM:MODF:TRI	

ATTEN:LOCK	FM2:MODF:PHASE
ATTEN:UNLOCK	FM2:MODF:Retn
	FM2:MODF:SIN
CFRQ:Dn	FM2:MODF:SQR
CFRQ:Inc	FM2:MODF:TRI
CFRQ:Retn	FM2:MODF:Up
CFRQ:Up	FM2:MODF[:VALUE]
CFRQ[:VALUE]	FM2:MODF:Xfer
CFRQ:Xfer	FM2:OFF
	FM2:ON
DCFMNL	FM2:Retn
FM[:DEVN]	FM2:Up
FM:Dn	FM2:Xfer
FM:EXTAC	
FM:EXTDC /	MOD:OFF
FM:Inc	MOD:ON
FM:INT	MODE
FM:MODF:Dn	
FM:MODF:Inc	PM[:DEVN]
FM:MODF:PHASE	PM:Dn
FM:MODF:Retn	PM:EXTAC
FM:MODF:SIN	PM:Inc
FM:MODF:SQR	PM:INT
FM:MODF:TRI	PM:MODF:Dn
FM:MODF:Up	PM:MODF:Inc
FM:MODF[:VALUE]	PM:MODF:PHASE
FM:MODF:Xfer	PM:MODF:Retn
FM:OFF	PM:MODF:SIN
FM:ON	PM:MODF:SQR
FM:Retn	PM:MODF:TRI
FM:Up	PM:MODF:Up
FM:Xfer	PM:MODF[:VALUE]
	PM:MODF:Xfer
FM2[:DEVN]	PM:OFF
FM2:Dn	PM:ON
FM2:EXTAC	PM:Retn
FM2:EXTDC	PM:Up
FM2:Inc	PM:Xfer
FM2:INT	
FM2:MODF	PM2[:DEVN]
FM2:MODF:Dn	PM2:Dn/nquery/
FM2:MODF:Inc	PM2:EXTAC/nquery/

PM2:Inc	RPP:TRIPPED?
PM2:INT/nquery/	
PM2:MODF:Dn	STO:MEM
PM2:MODF:Inc	
PM2:MODF:PHASE	SWEp:CFRQ:INC
PM2:MODF:Retn	SWEp:CFRQ:LOGInc
PM2:MODF:SIN	SWEp:CFRQ:START
PM2:MODF:SQR	SWEp:CFRQ:STOP
PM2:MODF:TRI	SWEp:CFRQ:TIME
PM2:MODF:Up	SWEEP:CONT
PM2:MODF[:VALUE]	SWEp:GO
PM2:MODF:Xfer	SWEp:HALT
PM2:OFF	SWEp:MODE
PM2:ON	SWEp:RESet
PM2:Retn	SWEp:TRIGger
PM2:Up	SWEp:TYPE
PM2:Xfer	
	:CCR?
PULSE:OFF	:CSE
PULSE:ON	:CSR?
	:HCR?
RFLV:Dn	:HSE
RFLV:Inc	:HSR?
RFLV:OFF	:SCR?
RFLV:ON	:SSE
RFLV:Retn	:SSR?
RFLV:Up	
RFLV[:VALUE]	:HELP? gives a list of 2023 commands accepted by the instrument. It is not itself a 2023 command.
RFLV:Xfer	
RPP:COUNT?	
RPP:RESET	

Format of ARB files

General

The ARB stores digital representations of waveforms. Up to 180 different waveforms can be stored, each capable of holding 131072 samples. The memory used is non-volatile, ensuring that information is retained when the power is switched off.

Each waveform consists of two components, I and Q. When the ARB is enabled and one of the waveforms selected, it is converted into a pair of analog signals that can be used to drive the I and Q channels of the RF modulator. Waveform data files are created externally and require packaging before they can be used by the ARB.

The ARB memory can be divided into 180 equal subsectors. A waveform occupies one or more subsectors depending on the number of samples in the waveform.

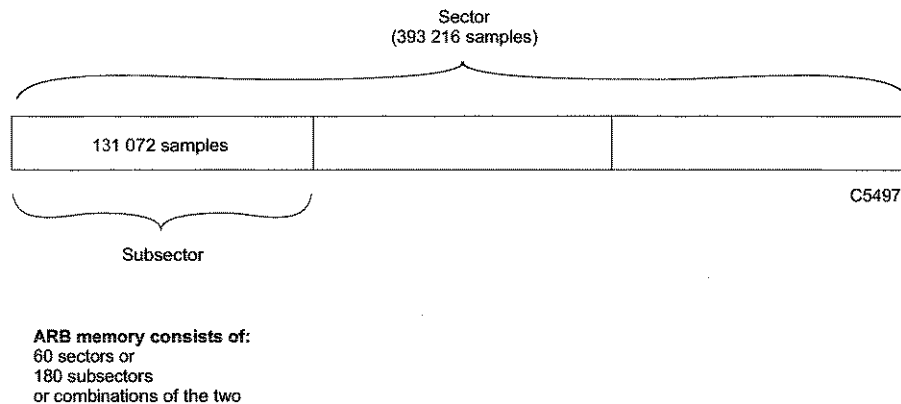

Fig. 3-128 ARB memory allocation

If the ARB is to store 180 waveforms, each must be no more than 131072 samples long. Each sample contains two 14-bit numbers, one each for I and Q.

Each symbol (or chip in the case of CDMA) must be represented by at least four ARB samples of the waveform in order for it to be reconstructed correctly. To minimize the required file size and reduce aliasing problems, the ARB includes an interpolator to increase the D-A converter sample rate by factors of between 2 and 3072 so that the D-A converter runs at between 44 and 66 M sample/s. Unless the waveform to be generated is a narrow-band signal there is little technical merit in increasing the number of samples in the ARB file to more than four samples per symbol or chip.

A waveform is looped continuously. The rate at which the sample plays is set during file creation.

An example showing data rates and sizes for an IS-95 waveform

IS-95 has a chip rate of 1.2288 Mchip/s. For our purposes we will consider a chip to be the significant symbol. Each symbol must be sampled at least four times. This would give a rate of 4.9152 Msample/s. There are 24 576 symbols per 20 ms frame. Four frames would have 98 304 symbols, which after oversampling gives 393 216 samples.

Such a file would occupy one sector of memory; the ARB can store 60 such files.

If each symbol was sampled more than four times the output data rate would be different and the file larger. Fewer such files could be stored.

When the above waveform is selected and played, it is read out of the memory at 4.9152 Msample/s. The ARB interpolates this data stream so that it has a data rate of 58.9824 Msample/s.

The data is written to the two 14-bit D-A converters at 58.9824 Msample/s. The analog outputs from the D-A converters are then filtered to remove switching and quantization noise and high-frequency images. The I and Q outputs are then routed to the RF modulator.

Markers

Markers are used to mark important events within the file; for example, the location of a burst, the start of a TDMA slot or frame.

Format for header of ARB IQ files (*.AIQ)

	Comment	No. of bytes
[File]		
Date=	Date file was created (mm/dd/yyyy)	12
Time=	Time file was created (hh:mm:ss)	10
PackSWVers=nn.nn	SW version of Packager (user files must set nn.nn = 00.00)	5
Samples=	No. of IQ Samples as an ASCII number	8
Title=	Name of AIQ file without extension and without path	80
SampleRate=	In Hz, in steps of 100 Hz, converted from user entry in packager	8
Description=	Description field entered in packager	120
RMS=	RMS value of the stored waveform	9
RelRMS=	RMS relative to maximum (dB)	8
CrestFactor=	Crest factor of stored waveform	8
LevelMode=	Instrument level mode	9 ¹
SymbolRate=	Symbol rate in Hz (may be used to set leveling loop bandwidth)	8
AlcBW=	Three text strings are allowed: "Narrow" "Broad" "Moderate" They are used to set the ALC bandwidth.	8

¹ Allowed values are IQScaled and IQDefault. The default should be IQDefault.

The remaining sections are only placed in the header if markers are used:

	Comment	No. of bytes
[Ramp]		
Delay=	Max delay in samples (may convert from time in packager)	6
UpProfile=	Up ramp profile type	4 ¹
DownProfile=	Down ramp profile type	4 ²
UpProfDur=	Up profile duration in samples	6
DownProfDur=	Down profile duration in samples	6
AltLevel=	The alternate level in dB (0 to 70 dB in 0.01 dB steps)	5
[Assign]		
Mkr1=	Marker 1 assignment (Power ramp)	12 ²
Mkr2=	Marker 2 assignment (amplitude)	12 ²
Mkr3=	Marker 3 assignment	12 ²
Mkr4=	Not currently used	12 ²

All headers are stored as ASCII strings, each line terminated with CR/LF.

The header is terminated by a ^Z. Data following the header is the IQ and marker data stored as IQIQIQ...

The format is:

bit number	31	30	29	28	27	26	25	24	23	22	21	20	19	18	17	16
	S	Q	Q	Q	Q	Q	Q	Q	Q	Q	Q	Q	Q	Q	M2	M1

bit number	15	14	13	12	11	10	9	8	7	6	5	4	3	2	1	0
	S	I	I	I	I	I	I	I	I	I	I	I	I	I	M4	M3

where Mn = marker number n, S = sign bit.

The last 32-bit value in the file is a checksum that is calculated as the running unsigned sum of the 32-bit numbers.

¹ Allowed types are: cos2, gaus, fast.

² Allowed assignments are: NotUsed, Ramp (Mkr1 only), Level (Mkr2 only), Gen.

Virtual front panel

The virtual front panel allows you to control a 3410 Series instrument via a remote interface from a Windows 95 (or higher) or NT-compatible PC. You need a National Instruments GPIB interface card or an Ethernet connection. The virtual front panel mimics operation of the front panel on the instrument. Mouse clicks replace touch screen operations and key presses, and the virtual front panel display returns the current instrument settings.

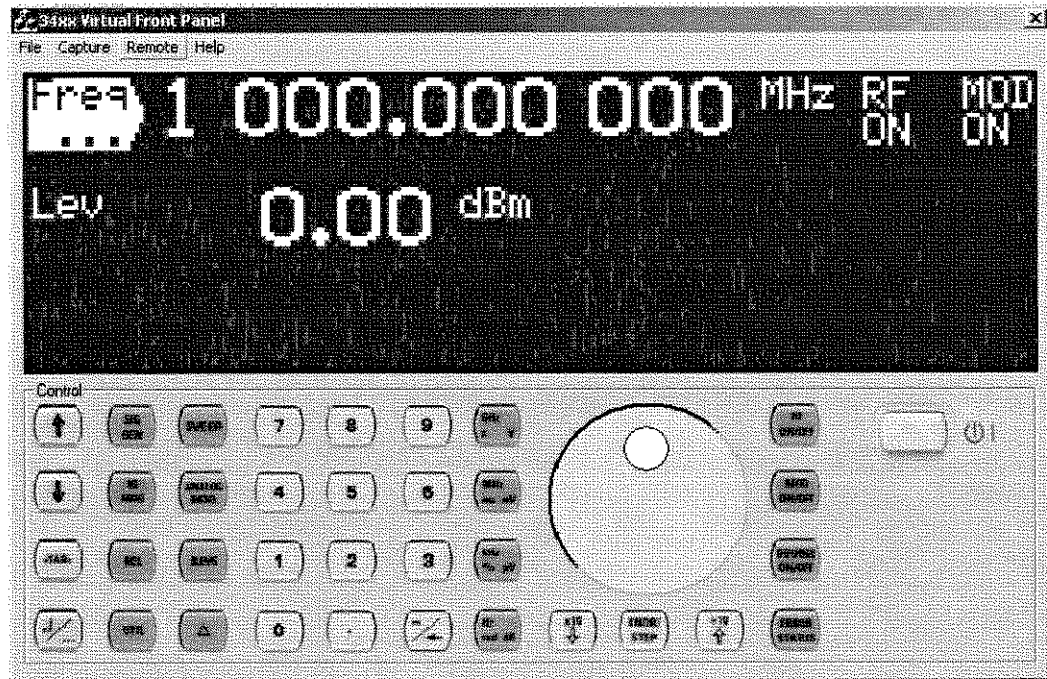

Fig. 3-129 Virtual front panel

The :VFPanel remote command set (page 4-189) simulates operation from the instrument's front panel. The instrument is placed into a mode in which it maintains a virtual copy of the current front panel display as a bitmap. This bitmap is then read from the instrument as a remote command. A set of remote commands provides control of the instrument by simulating key and touchscreen entries and rotary control movements.

C

C

C

E

Chapter 4

REMOTE OPERATION

Contents

REMOTE OPERATION COMMANDS	4-3
Introduction.....	4-3
Where to find commands	4-3
CONVENTIONS USED IN THIS MANUAL	4-4
Common commands	4-11
Commands recognized by all IEEE 488.2 instruments	
Output control commands.....	4-17
Mod. source on/off, RPP, RF on/off	
Reference oscillator commands	4-27
Internal/external reference frequency	
The [SOURce] subsystem — an introduction.....	4-31
Commands that cover all aspects of frequency, modulation, power and sweeping	
RF output frequency commands.....	4-33
Carrier frequency, phase, sweep	
List commands	4-41
List mode sweep handling and triggering	
AM commands	4-49
AM depth, source, frequency, waveshape, mod. sweep, phase, input parameters	
Burst commands.....	4-61
Burst source, rise and fall times, attenuation, position	
Frequency hopping commands.....	4-75
List handling, operating modes, marker setup, source settings	
FM commands.....	4-81
FM deviation, source, frequency, waveshape, mod. sweep, phase, input parameters, DC null	
IQ commands	4-93
IQ source parameters, digital filters, RTBB, differential IQ and ARB handling	
IQ commands — ARB subsystem.....	4-105
IQ ARB waveform generation, handling and parameter set-up	
IQ commands — DM subsystem	4-113
IQ DM: Digital waveform generation, file handling and clock set-up	
IQ commands — DM:Tones subsystem.....	4-119
IQ:DM:Tones set-up	
IQ commands — DM:Generic subsystem.....	4-123
IQ:DM:Generic set-up	
Phase modulation commands.....	4-133
Phase modulation deviation, source, frequency, waveshape, mod. sweep, phase, input parameters	
Pulse modulation commands.....	4-145
Pulse modulation source, control	
Power commands	4-147
ALC, carrier level, carrier level sweeping, level steps, offsets, max. RF level	

Sweep commands	4-157
Sweep handling and triggering	
Instrument system-level commands	4-161
Ethernet setup, GPIB address, RS-232 setup, error queue, keyboard locking, SCPI/2023 commands, power-up and memory handling, touch screen on/off, SCPI version	
Measurement unit commands.....	4-171
Output level/voltage units	
Calibration commands	4-173
Diagnostic commands	4-177
Attenuator count, RPP trip count, elapsed operating time, hardware and system options, version and part numbers	
Display commands	4-185
Screen blanking, contrast	
Virtual front panel commands.....	4-189
Virtual front panel display and controls	
Status commands	4-195
Commands for determining the state of the instrument	
Status reporting	4-198
Reading status information	4-200
Remote status reporting structure.....	4-203

REMOTE OPERATION COMMANDS

Introduction

This instrument may be operated remotely via an interface that conforms to:

IEEE Std 488.1-1987, which defines the electrical, mechanical and low-level protocol characteristics of the bus structure, the GPIB (General Purpose Interface Bus)

IEEE Std 488.2-1987, which defines standard codes, formats, protocols and common commands for use with IEEE Std 488.1.

The instrument is not fully compliant with SCPI (Standard Commands for Programmable Instruments) because many product features are not covered by that standard, and modern software trends favor the use of instrument drivers as a means of achieving interchangeability.

However, we recognize that SCPI is in common use by system developers and a number of SCPI features that make system integration easier have been implemented. These include the extended status reporting structure, the error-numbering scheme, the command mnemonic derivation rules (long and short form), and many of the most frequently used commands themselves. Refer to SCPI 1997 for details.

Where to find commands

Commands are grouped into particular subsystems on the following pages, as shown in the Contents. Under each heading is an overview of the commands within that subsystem, which will help you quickly locate commands by function. Commands are arranged alphabetically within subsystems.

You will also find cross-references to individual commands from the operating instructions of Chapter 3 and from the Index.

Parameter ranges

Refer to the performance data in Chapter 1 for valid ranges for parameters.

CONVENTIONS USED IN THIS MANUAL

Abbreviations

Long and short forms

The elements of compound and query headers have a long and a short form, as defined by SCPI. Either the long or the short form may be entered as a command; other abbreviations are not permissible.

Example:

```
STATus:OPERation:EVENT?
```

is interpreted the same as

```
STAT:OPER:EVEN
```

The short form is marked by upper-case letters, the long form corresponds to the complete word. Upper-case and lower-case serve the above purpose only, as the instrument itself does not make any distinction between upper-case and lower-case letters.

Queries always return the short form, or a numeric response in those cases where the command provides a choice of numeric or character data.

Bracketed elements

Square brackets []

Elements within the compound common program header structure that are enclosed within square brackets are optional and therefore may be omitted; the instrument processes the command in the same manner whether the bracketed element is included or not.

Example:

```
[SOURCE:]POWER[:LEVEL][:IMMEDIATE][:AMPLITUDE]
```

is interpreted the same as

```
POWER
```

This applies to parameters also. The ability to recognize the full command length ensures that the instrument complies with the SCPI standard in this respect.

Curly brackets { }

Parameters included within curly brackets may be included any number of times or not at all.

Angle brackets < >

Text within angle brackets represents an actual value that needs to be inserted: for example, <freq> shows that you need to insert a frequency value in the command at this point.

Case

The software is not case-sensitive. Upper- and lower-case characters are completely interchangeable. There is no conflict between milli (m) and mega (M) as both cannot be applied to the same data.

Choices

The vertical bar (|)

- separates a choice of parameters:

for example, 0 | 1 means '0 or 1'

or

- separates a choice of commands:

for example, the vertical bar in [SOURCE]:MODulation]:AM[1]|2[:DEPTH] means that you can set the AM depth for either path 1 or path 2 (path 1 is the default): the short-form versions of the commands are AM or AM2.

Compound program headers

Compound program headers allow a complex set of commands to be built up from a smaller set of basic elements in a tree structure. The elements of a compound program header are separated by a colon (:), each colon representing a change of level in the hierarchy. Each subsystem in this instrument is organized as a separate tree structure.

The compound program header may, optionally, be followed by one or more parameters encoded as program data functional elements.

Example:

```
OUTput:ATTenuation:AUTO 0
```

Note: A leading colon is optional

Program data

Program data functional elements contain the parameters related to the program header(s). The following program data functional elements are accepted by the instrument:

<CPD>	(also known as <CHARACTER PROGRAM DATA>)
<NRf>	(also known as <DECIMAL NUMERIC PROGRAM DATA>)
<numeric_value>	(defined by SCPI)
<STRING PROGRAM DATA>	
<Boolean>	(defined by SCPI)
<ARBITRARY BLOCK PROGRAM DATA>	

These functional elements are defined in IEEE 488.2 and the SCPI Syntax and Style handbook.

A white space must separate the command header(s) and the program data.

<white space>, as defined in IEEE Std 488.2, can be any number of ASCII characters in the range 0–9, 11–32 decimal.

<white space> is also allowed at other points in a message.

<CPD>

Character program data is used to set a parameter to one of a number of states that are best described by short alphanumeric strings.

Example:

ON

<NRf>

Flexible numeric representation covers integer and floating-point representations.

Examples:

-466	Integer value
4.91	Explicitly-placed decimal point
59.5E+2	Mantissa and exponent representation

The format is known as 'flexible' because any of the three representations may be used for any type of numeric parameter.

Examples:

Where a parameter requires an integer value in the range 1 to 100, and the user needs to set its value to 42, the following values are accepted by the instrument:

42	Integer
42.0	Floating point
4.2E1, 4200E-2	Floating point – mantissa/exponent
41.5	Rounded up to 42
42.4	Rounded down to 42

<numeric_value>

<numeric_value> is a superset of <NRf> and <CPD>, used when parameters may consist of either a decimal value or the shorthand notations MAXimum or MINimum.

Example:

FREQ:STEP has a <numeric_value> parameter. This means that valid values for the step size may be the frequency value in Hz (for example, 250E+3), or MAXimum or MINimum.

<STRING PROGRAM DATA>

String program data consists of a number of ASCII characters enclosed in quotes. Use either pairs of single (ASCII 39) or double (ASCII 34) quotes, but do not mix single and double in a string. A quote within a string must be enclosed within an extra pair of quotes.

Example:

This string contains the word 'Hello''

is interpreted as

This string contains the word 'Hello'

and

"This string contains the word "Hello" "

is interpreted as

This string contains the word "Hello".

<Boolean>

<Boolean> is used as shorthand for the form ON | OFF | <NRf>. Boolean parameters have a value of 0 or 1 and are unitless.

On input, an <NRf> is rounded to an integer and a nonzero result is interpreted as 1.

<CPD> elements ON and OFF are accepted as inputs, with ON corresponding to 1 and OFF corresponding to 0. Queries return 1 or 0, never ON or OFF.

Examples:

ON is interpreted as 1

0.4 is interpreted as 0

2.8 is interpreted as 1

<ARBITRARY BLOCK PROGRAM DATA>

Definite format

Arbitrary block program data consists of 8-bit data bytes (DAB), preceded by ASCII header bytes that define the number of data bytes following, in the form

```
#<non-zero digit><digit><DAB><DAB><DAB><DAB>...
```

where

ASCII character # introduces the block program data

<non-zero digit> is a single ASCII-encoded byte (in the range 31–39) that defines the number of <digit> elements

<digit> is one or more ASCII-encoded bytes (in the range 30–39) that define the number of data bytes following.

Examples:

```
#14<DAB><DAB><DAB><DAB> represents four 8-bit bytes of data.
```

```
#3128<DAB>...(128 times)...<DAB> represents 128 8-bit bytes of data.
```

During the transmission of data bytes, the instrument is instructed to ignore control characters, as it is possible that some combinations of data bytes might otherwise appear to be random control characters.

Indefinite format

The instrument also accepts the indefinite format, with an undefined number of 8-bit bytes of data

```
#0<DAB><DAB><DAB>...<DAB>NL^END
```

which forces an immediate termination of the program message.

Response data

The following response data functional elements are generated by the instrument:

<CRD> (also known as <CHARACTER RESPONSE DATA>
<NR1>
<NR2>
<NR3>
<STRING RESPONSE DATA>

<CRD>

This type of response is returned when reading the value of a parameter that can take a number of discrete states. States are represented by short alphanumeric strings.

Example:

ON

<NR1>

This type of numeric response is used when returning the value of integer parameters, such as an averaging number or the number of measurement points.

Examples:

15
+3
-57

<NR2>

This type of numeric response includes an explicitly placed decimal point, but no exponent.

Examples:

17.91
-18.27
+18.83

<NR3>

This type of numeric response includes an explicitly placed decimal point and an exponent.

Examples:

1.756E+2
182.8E-3

<STRING RESPONSE DATA>

This takes a similar form to <STRING PROGRAM DATA> except that the delimiting character is always a double quote ("ASCII 34").

<DEFINITE LENGTH ARBITRARY BLOCK RESPONSE DATA>

This takes a similar form to <ARBITRARY BLOCK PROGRAM DATA>.

Example:

```
#206<DAB><DAB><DAB><DAB><DAB><DAB>
```

represents six 8-bit bytes of returned data.

Terminators

A <PROGRAM MESSAGE TERMINATOR> (as defined in IEEE 488.2) can be a newline character (ASCII 10), a newline character with the ^END message asserted at the same time, or an ^END message asserted with the final character of the <PROGRAM MESSAGE>. The terminator may be preceded by any number of 'white space' characters — any single ASCII-encoded byte in the ranges 0 to 9 and 11 to 32 decimal.

A <RESPONSE MESSAGE TERMINATOR> (as defined in IEEE 488.2) is a newline character with the ^END message asserted at the same time.

Many GPIB controllers terminate program messages with a newline character and, by default, accept newline as the response message terminator. When transferring binary data, which may contain embedded newline characters, ensure that the controller uses only ^END messages. Usually this means that the controller's GPIB must be set up to generate and detect ^END. Refer to the documentation supplied with the controller.

1

2

3

4

Common commands

(Common commands subsystem)

Commands recognized by all IEEE 488.2 instruments

The common commands are taken from the IEEE 488.2 standard. These commands have the same effect on any instrument that conforms to the standard. The headers of these commands consist of an asterisk (*) followed by three letters. Many common commands refer to the status reporting system.

The most important of the common commands is *RST, which places the instrument in a defined state. It is good practice to send *RST at the start of any program.

*CLS
*ESE\
*ESR?
*IDN?
*OPC\
*OPT?
*RST
*SRE\
*STB?
*TST?

***CLS**

Description: Clear status clears the standard event register, the error queue, the operation event register and the questionable event register.

Parameters: None

***ESE**

Description: The event status enable command sets the standard event status enable register to the value specified. This is an eight-bit register.

Parameters: <NRf>
Mask

Valid values: Mask: integer. Valid values are 0 to 255. Values outside range are rejected and an error generated.

***ESE?**

Description: Reads the event status enable register. This is an eight-bit register. The contents of the event status enable register are returned in decimal form.

Parameters: None

Response: <NR1>
Mask

Returned values: Mask: integer. Values are in the range 0 to 255.

***ESR?**

Description: Reads the value of the standard event status register. This is an eight-bit register. The contents of the register are returned in decimal form. Subsequently the register is set to zero.

Parameters: None

Response: <NR1>
Register contents

Returned values: Register contents: integer. Values are in the range 0 to 255.

***IDN?**

Description: The identification query command allows information about the instrument to be read.

Parameters: None

Response: <arbitrary ASCII response data>

Manufacturer, model, serial number, software part number and issue number

Returned values: Manufacturer: string
Always returns 'IFR'.

Model: string
This is the instrument's model number in the form 341x where:

341x	Description
3412	2 GHz Vector Signal Generator
3413	3 GHz Vector Signal Generator
3414	4 GHz Vector Signal Generator
3416	6 GHz Vector Signal Generator

Serial number: string
This is in the form ssssss/sss where s is an ASCII digit in the range 0 to 9.

Software part number and issue number: string
This is in the form ppppp/ppp/ii.ii where p and i are ASCII digits in the range 0 to 9.

***OPC**

Description: The operation complete command sets the operation complete bit (bit 0) in the standard event status register when execution of the preceding operation is complete. This bit can be used to initiate a service request.

**OPC should be the final <program message unit> of the <program message>.*

Parameters: None

Example: :CAL; *OPC

Initiate a level calibration. The Operation Complete bit is set in the Standard Event Status Register when the instrument has finished.

***OPC?**

Description: The operation complete query returns a '1' when the preceding operation has completed.

**OPC? should be the final <query message unit> of the <program message>.*

Parameters: None

Response: <NR1>
Operation complete

Returned values: Operation complete: integer. Value is 1.

***OPT?**

Description: Reads hardware options present. If no options are present a single '0' is returned, otherwise the response is up to six strings separated by commas.

Parameters: None

Response: <arbitrary ASCII response data>
Options

Returned values: Option 001 – No Attenuator
Option 002 – Mechanical Attenuator
Option 003 – Electronic Attenuator
Option 005 – Dual-Channel ARB
Option 006 – Pulse Modulation
Option 007 – Rear Panel Outputs
Option 008 – Real-Time Baseband
Option 009 – Differential IQ
Option 010 – List Mode
Option 020 – 2G CDMA License
Option 021 – 2G & 3G CDMA License

***RST**

Description: Resets the instrument to a known configuration appropriate for remote operation: see page 3-156.

Parameters: None

***SRE**

Description: Sets the service request enable register. This is an eight-bit register.

Parameters: <NRf>
Mask

Valid values: Mask: integer. Valid values are 0 to 255. Values outside range are rejected and an error is generated.

***SRE?**

Description: Reads the service request enable register. This is an eight-bit register.

Parameters: None

Response: <NR1>
Mask

Returned values: Mask: integer. Values are in the range 0 to 255.

***STB?**

Description: Reads the status byte. This is an eight-bit register.

Parameters: None

Response: <NR1>
Status byte

Returned values: Status byte: integer. Values are in the range 0 to 255.

***TST?**

Description: Self test query. Returns a '0' when the remote operation interface and processor are operating correctly.

Parameters: None

Response: <NR1>
Self test completed

Returned values: Self test completed: integer. Value is 0.

Output control commands

(OUTPut subsystem)

Mod. source on/off, RPP, RF on/off

Commands for:

- Turning each modulation path on or off
- Querying the state of, and resetting, RPP
- Turning the RF output on or off.

The OUTput subsystem effectively controls the switching of modulation paths within the instrument. Fig. 4-1 on page 4-19 is a representation of the OUTput and SOURce commands and their relationship to the sources. You can see from this that the OUTput commands control the outputs of the sources as well as the combined modulation output.

Not shown on this diagram is the OUTput[:POWER][:STATE] command, which controls the instrument's final RF output.

Note that this diagram is intended to show the effect of commands on the routing of sources and modulation paths, and does not necessarily represent actual hardware in the instrument.

OUTPut

:LVDS	
:[STATE]\?	
:MODulation	Enable/disable modulation...
:AM[1] 2	
:[STATE]\?	...AM
:BURst	
:[STATE]\?	...burst
:FHOPping	
:[STATE]\?	...frequency hopping
:FM[1] 2	
:[STATE]\?	...FM
:IQ	
:[STATE]\?	...IQ
:PM[1] 2	
:[STATE]\?	...phase
:PULM	
:[STATE]\?	...pulse
:[STATE]\?	...all
[:POWER]	
:PROTection	Reverse power protection
:CLEar	
:TRIPped?	
:[STATE]\?	

Why do we have the [SOURCE]:MODulation:<modn>:STATE and OUTput:MODulation:<modn>[:STATE] commands?

The [SOURCE]:MODulation:<modn>:STATE command allows you to make individual sources active to provide the overall modulation that you need.

For example, [SOURCE]:MODulation:AM:STATE corresponds to the  soft box:

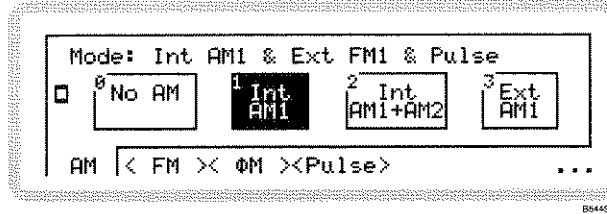

and provides SCPI-like control of modulation.

The OUTput:MODulation:<modn>[:STATE] command allows you to switch individual sources on or off without affecting the modulation mode that you have created.

For example, OUTput:MODulation:AM[:STATE] corresponds to *AM State* in the AM1 sub-menu:

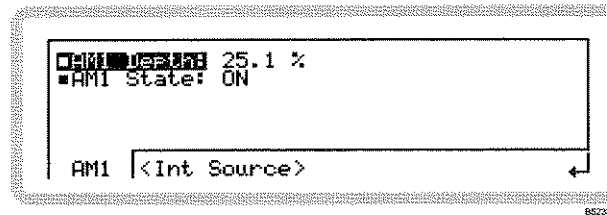

and has the same effect as the SOURCE ON/OFF key on the front panel.

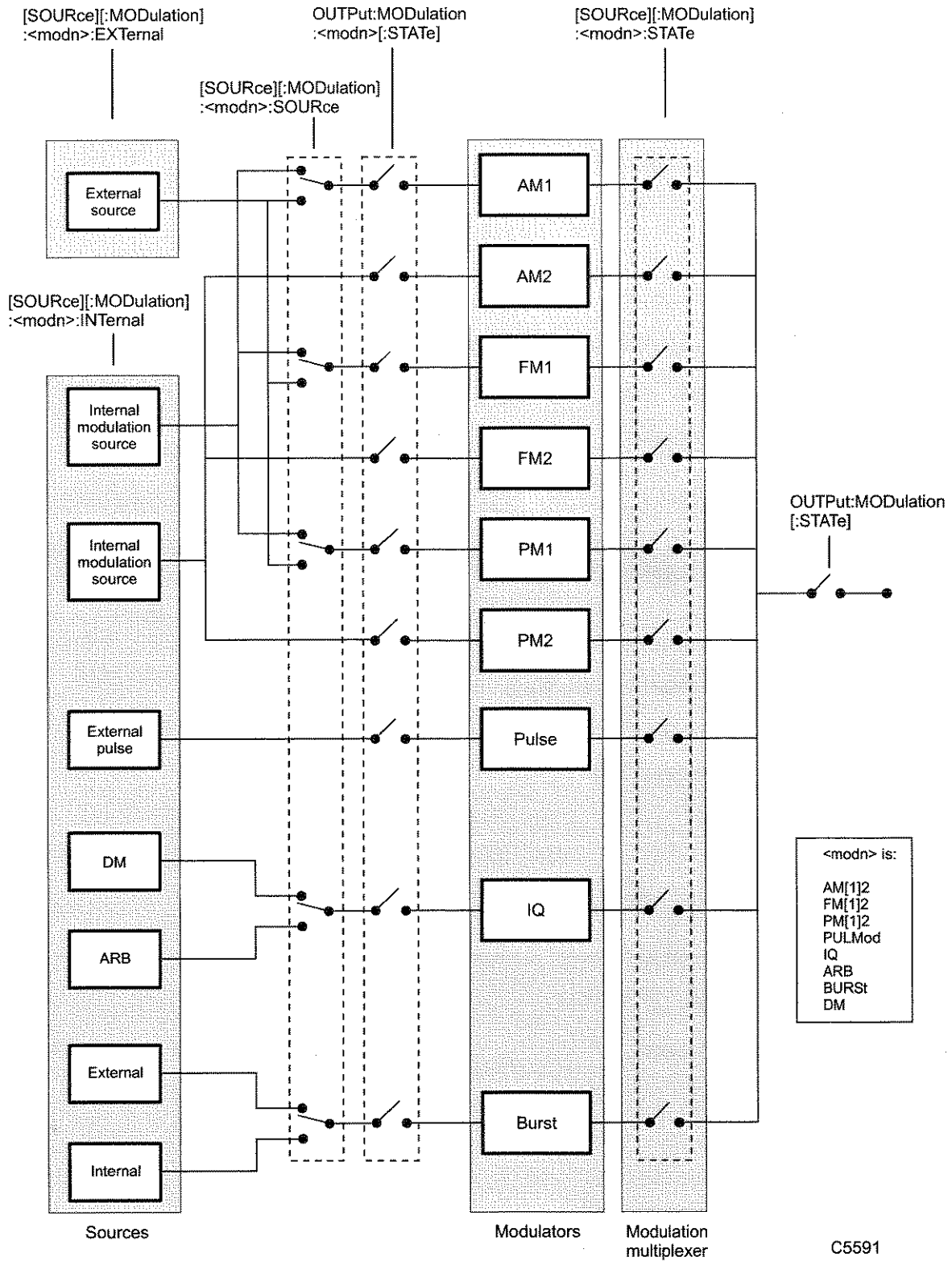

Fig. 4-1 Modulation generator switching

OUTPut:LVDS[:STATe]

Description: Turns the LVDS input on or off.

Parameters: <Boolean>

Valid values: OFF | ON | 0 | 1

*RST sets: ON

OUTPut:LVDS[:STATe]?

Description: Queries the state of the LVDS source.

Parameters: None

Response: <Boolean>

Returned values: 0 | 1

OUTPut:MODulation:AM[1]|2[:STATe]

Description: Turns the source feeding the AM1 or AM2 modulator on or off; other active modulators are not affected. See Fig. 4-1 on page 4-19.

Corresponds to the SOURCE ON/OFF key.

Parameters: <Boolean>

Valid values: OFF | ON | 0 | 1

*RST sets: ON

OUTPut:MODulation:AM[1]|2[:STATe]?

Description: Queries the state of the amplitude modulation source.

Parameters: None

Response: <Boolean>

Returned values: 0 | 1

OUTPut:MODulation:BURst[:STATe]

Description: Turns the source feeding the burst modulator on or off; other active modulators are not affected. See Fig. 4-1 on page 4-19.

Corresponds to the SOURCE ON/OFF key.

Parameters: <Boolean>

Valid values: OFF | ON | 0 | 1

*RST sets: ON

OUTPut:MODulation:BURst[:STATe]?

Description: Queries the state of the burst modulation source.

Parameters: None

Response: <Boolean>

Returned values: 0 | 1

OUTPut:MODulation:FHOPping[:STATe]

Description: Turns the source feeding the frequency hopping modulator on or off; other active modulators are not affected. See Fig. 4-1 on page 4-19.

Corresponds to the SOURCE ON/OFF key.

Parameters: <Boolean>

Valid values: OFF | ON | 0 | 1

*RST sets: ON

OUTPut:MODulation:FHOPping[:STATe]?

Description: Queries the state of the frequency hopping source.

Parameters: None

Response: <Boolean>

Returned values: 0 | 1

OUTPut:MODulation:FM[1]|2[:STATe]

Description: Turns the source feeding the FM1 or FM2 modulator on or off; other active modulators are not affected. See Fig. 4-1 on page 4-19.

Corresponds to the SOURCE ON/OFF key.

Parameters: <Boolean>

Valid values: OFF | ON | 0 | 1

*RST sets: ON

OUTPut:MODulation:FM[1]|2[:STATe]?

Description: Queries the state of the frequency modulation source.

Parameters: None

Response: <Boolean>

Returned values: 0 | 1

OUTPut:MODulation:IQ[:STATe]

Description: Turns the source feeding the IQ modulator on or off; other active modulators are not affected. See Fig. 4-1 on page 4-19.

Corresponds to the SOURCE ON/OFF key.

Parameters: <Boolean>

Valid values: OFF | ON | 0 | 1

*RST sets: ON

OUTPut:MODulation:IQ[:STATe]?

Description: Queries the state of the IQ modulation source.

Parameters: None

Response: <Boolean>

Returned values: 0 | 1

OUTPut:MODulation:PM[1]|2[:STATe]

Description: Turns the source feeding the PM1 or PM2 modulator on or off; other active modulators are not affected. See Fig. 4-1 on page 4-19.

Corresponds to the SOURCE ON/OFF key.

Parameters: <Boolean>

Valid values: OFF | ON | 0 | 1

*RST sets: ON

OUTPut:MODulation:PM[1]|2[:STATe]?

Description: Queries the state of the phase modulation source.

Parameters: None

Response: <Boolean>

Returned values: 0 | 1

OUTPut:MODulation:PULM[:STATe]

Description: Turns the source feeding the pulse modulator on or off; other active modulators are not affected. See Fig. 4-1 on page 4-19.

Corresponds to the SOURCE ON/OFF key.

Parameters: <Boolean>

Valid values: OFF | ON | 0 | 1

*RST sets: ON

OUTPut:MODulation:PULM[:STATe]?

Description: Queries the state of the pulse modulation source.

Parameters: None

Response: <Boolean>

Returned values: 0 | 1

OUTPut:MODulation:RESet

Description: Equivalent to *RST (page 4-14) for all modulation parameters.

OUTPut:MODulation[:STATe]

Description: Enables or disables all the active modulation outputs. See Fig. 4-1 on page 4-19.

When ON, this command causes each modulation output to adopt the state set by its relevant [SOURce][:MODulation]:<modn>:STATe command (page 4-49 onwards).

The carrier (controlled by the OUTPut[:POWer][:STATe] command, page 4-25) is not affected.

Corresponds to the MOD ON/OFF key.

Parameters: <Boolean>

Valid values: OFF | ON | 0 | 1

*RST sets: ON

OUTPut:MODulation[:STATe]?

Description: Queries the state of the active modulation outputs.

Parameters: None

Response: <Boolean>

Returned values: 0 | 1

OUTPut[:POWer]:PROTEction:CLEar

Description: Resets the reverse power protection circuit.

Parameters: None

OUTPut[:POWer]:PROTEction:TRIPped?

Description: Queries the state of the reverse power protection circuit: reset (0) or tripped (1).

Parameters: None

Response: <Boolean>

Returned values: 0 | 1

OUTPut[:POWer][:STATe]

Description: Turns the RF output on or off. This is the 'final' switch before the RF OUTPUT socket, and has no effect on the configuration of modulation paths within the instrument.

Corresponds to the RF ON/OFF key.

Parameters: <Boolean>

Valid values: OFF | ON | 0 | 1

*RST sets: OFF

OUTPut[:POWer][:STATe]?

Description: Queries whether the RF output is on (1) or off (0).

Parameters: None

Response: <Boolean>

Returned values: 0 | 1

C

C

C

D

Reference oscillator commands

(ROSCillator subsystem)

Internal/external reference frequency

Commands for:

- choosing the source of the instrument's reference oscillator
- outputting the internal reference signal.

ROSCillator

:INTernal

:ADJust

:SAVE

[:VALue]?

:SOURce\?

ROSCillator:INTernal:ADJJust:SAVE

Description: Saves the manually-entered offset from the reference oscillator's tuning value.

Parameters: None

*RST sets: No effect

ROSCillator:INTernal:ADJJust[:VALue]

Description: Sets an offset from the reference oscillator's tuning value, which is established during calibration.

Parameters: <numeric_value>

Valid values: <NRf> | MAXimum | MINimum

*RST sets: No effect

ROSCillator:INTernal:ADJJust[:VALue]?

Description: Queries the offset from the reference oscillator's tuning value.

Parameters: None

Response: <NR2>

Returned values: Offset frequency in Hz

ROSCillator:SOURCE

Description: Selects an internal or external frequency standard.

Parameters: <CPD>

Valid values: INT | EXT10DIR | EXT1IND | EXT10IND | INT10OUT

Internal | External 10 MHz direct | External 1 MHz indirect | External 10 MHz indirect | Internal 10 MHz out

Internal: the instrument's own internal 10 MHz standard.

External: a 1 or 10 MHz external standard.

Direct: the internal standard for the instrument's RF section is provided directly from the external standard.

Indirect: the internal standard is provided from the OCXO, locked to the external standard.

*RST sets: No effect

ROSCillator:SOURCE?

Description: Queries which frequency standard is selected.

Parameters: None

Response: <CRD>

Returned values: INT | EXT10DIR | EXT1IND | EXT10IND | INT10OUT

The [SOURce] subsystem — an introduction

The SOURce subsystem contains commands that cover all aspects of frequency, modulation, power and sweeping

The [SOURce] subsystem consists of:

- The [FREQuency] subsystem, which controls frequency parameters of the carrier and sweep signals
- The [LIST] subsystem, which controls list mode sweeping
- The [MODulation]:AM subsystem, which controls all aspects of AM modulation
- The [MODulation]:BURst subsystem, which controls external and internal burst control, attenuation and profiles
- The [MODulation]:FM subsystem, which controls all aspects of FM modulation
- The [MODulation]:IQ subsystem, which controls all aspects of internal and external IQ generation, including RTBB (digital modulation, DM) and ARB
- The [MODulation]:PM subsystem, which controls all aspects of pulse modulation
- The [MODulation]:PULM subsystem, which turns pulse modulation on or off
- The [POWer] subsystem, which sets all aspects of carrier and sweep levels
- The [SWEep] subsystem, which controls the generation of frequency and power sweep signals

Each of these subsystems is dealt with separately in the following sections.

The [SOURce] subsystem effectively controls the switching and configuration of internal and external signal sources and modulation paths within the instrument. Fig. 4-1 on page 4-19 is a representation of the OUTput and [SOURce] commands and their relationship to the sources.

You can see from this that the [SOURce] commands control:

the configuration of signal sources: [SOURce][:MODulation]:<modn>:EXTernal
[SOURce][:MODulation]:<modn>:INTernal;

the selection of signal sources: [SOURce][:MODulation]:<modn>:SOURce;

and switching modulation paths: [SOURce][:MODulation]:<modn>:STATe.

Note that Fig. 4-1 does not necessarily represent the actual hardware in the instrument.

The menu structure of the [SOURce] subsystem is as follows:

[SOURce]	
:FREQuency	Carrier frequency
:LIST	List mode sweep
[:MODulation]	Carrier modulation...
:AM[1] 2	...AM
:BURst	...burst
:FHOPping	...frequency hopping
:FM[1] 2	...FM
:IQ	...IQ, ARB, RTBB
:PM[1] 2	...phase
:PULM	...pulse
:POWer	RF level
:SWEep	Carrier/power sweep

C

C

C

D

RF output frequency commands

([SOURce]:FREQuency subsystem)

Carrier frequency, phase, sweep

Commands for:

- Setting carrier frequency, phase, phase reference, phase noise optimization and sensitivity
- Setting carrier frequency mode
- Setting carrier frequency step size
- Setting carrier sweep mode operating frequency
- Setting carrier sweep step size, spacing and mode
- Setting carrier sweep stop and start frequencies.

[SOURce]
:FREQuency
[:CW|:FIXed]\?
:STEP
[:INCRement]\?
:MODE\?
:PHASe
[:ADJust]\?
:OPTimisation\?
:REFerence\?
:SENSitivity\?
:SWEep
:DWELl\?
:MANual
:SPACing\?
:STARt\?
:STEP
[:LINear]\?
:LOGarithmic\?
:STOP\?

[SOURce]:FREQuency[:CWI:FIXed]

Description: Sets the carrier frequency by value, to maximum or minimum, stepping up or down, returning to the last full setting, or setting the current value to be the new setting.

Parameters: <numeric_value>

Valid values: <NRf>(Hz) | MAXimum | MINimum | UP | DOWN | RETurn | REFerence

*RST sets: MAX

[SOURce]:FREQuency[:CWI:FIXed]?

Description: Queries the carrier frequency by value.

Parameters: None

Response: <NR2>

Returned values: Carrier frequency in Hz

[SOURce]:FREQuency[:CWI:FIXed]:STEP[::INCRement]

Description: Sets the carrier frequency step size.

Parameters: <numeric_value>

Valid values: <NRf>(Hz) | MAXimum | MINimum

*RST sets: 1 kHz

[SOURce]:FREQuency[:CWI:FIXed]:STEP[::INCRement]?

Description: Queries the carrier frequency step size by value.

Parameters: None

Response: <NR2>

Returned values: Carrier frequency step size in Hz

[SOURce]:FREQuency:MODE

Description: Sets the mode of operation of the carrier frequency.

Parameters: <CPD>

Valid values: CW | FIXed | SWEEp | LIST

CW and FIXed are aliases; both are implemented here, as required by SCPI.

*RST sets: CW

[SOURce]:FREQuency:MODE?

Description: Queries the mode of operation of the carrier frequency.

Parameters: None

Response: <CRD>

Returned values: CW | FIX | SWE | LIST

[SOURce]:FREQuency:PHASe[:ADJust]

Description: Sets the carrier frequency phase.

Parameters: <NR1>

Valid values: -360° to 0° to +360°

*RST sets: 0°

[SOURce]:FREQuency:PHASe[:ADJust]?

Description: Queries the carrier frequency phase.

Parameters: None

Response: <NR2>

Returned values: Degrees

[SOURCE]:FREQUENCY:PHASE:OPTImisation

Description: Sets the phase noise performance.

Parameters: <CPD>

Valid values: LTEN less than 10 kHz: optimizes phase noise less than 10 kHz away from carrier (gives faster synthesizer settling)

GTEN greater than 10 kHz: optimizes phase noise more than 10 kHz away from carrier (gives slower synthesizer settling)

*RST sets: GTEN

[SOURCE]:FREQUENCY:PHASE:OPTImisation?

Description: Queries the phase noise setting.

Parameters: None

Response: <CRD>

Returned values: LTEN | GTEN

[SOURCE]:FREQUENCY:PHASE:REFerence

Description: Sets the current carrier frequency phase as a zero reference.

Parameters: None

[SOURCE]:FREQUENCY:PHASE:REFerence?

Description: Queries the carrier frequency's phase relative to the zero reference.

Parameters: None

Response: <NR2>

Returned values: Degrees

[SOURce]:FREQuency:PHASe:SENSitivity

Description: Sets the sensitivity of the rotary control when setting up carrier phase shift.

Parameters: <CPD>

Valid values: FINE (0.036°)
MEDIum (0.360°)
COARse (1.44°)

*RST sets: FIN

[SOURce]:FREQuency:PHASe:SENSitivity?

Description: Queries the sensitivity of the rotary control.

Parameters: None

Response: <CRD>

Returned values: FIN | MED | COAR

[SOURce]:FREQuency:SWEep:DWEL

Description: Sets the time per sweep step for the carrier frequency.

Parameters: <NRf>

*RST sets: 50 ms

[SOURce]:FREQuency:SWEep:DWELI?

Description: Queries the time per sweep step for the carrier frequency.

Parameters: None

Response: <NR2>

Returned values: Time in s.

[SOURce]:FREQ:SWEEP:MANual

Description: Sets a new carrier frequency whilst a sweep is paused.

Parameters: <numeric_value>

Valid values: <NRf>(Hz) | MAXimum | MINimum | UP | DOWN

Set by value, to maximum or minimum, or stepping up or down.

This command is available only when FREQ:MODE SWEEP is selected, and sweep operation is not in progress (PAUSED or WAITING FOR TRIGGER). The frequency value should be limited to the range determined by FREQ:SWEEP:START and FREQ:SWEEP:STOP.

[SOURce]:FREQ:SWEEP:MANual?

Description: Queries the carrier frequency set during a paused sweep.

Parameters: None

Response: <NR2>

Returned values: Carrier frequency in Hz

[SOURce]:FREQ:SWEEP:SPACing

Description: Sets the carrier sweep step points to either linear or logarithmic spacing.

Parameters: <CPD>

Valid values: LINear | LOGarithmic

*RST sets: LIN

[SOURce]:FREQ:SWEEP:SPACing?

Description: Queries whether carrier sweep step points have linear or logarithmic spacing.

Parameters: None

Response: <CRD>

Returned values: LIN | LOG

[SOURce]:FREQuency:SWEep:START

Description: Sets the start frequency for a carrier sweep.

Parameters: <numeric_value>

Valid values: <NRf>(Hz) | MAXimum | MINimum

*RST sets: MIN

[SOURce]:FREQuency:SWEep:START?

Description: Queries the start frequency for a carrier sweep.

Parameters: None

Response: <NR2>

Returned values: Start frequency in Hz

[SOURce]:FREQuency:SWEep:STEP[:LINear]

Description: Sets the size of linear carrier sweep steps.

Parameters: <numeric_value>

Valid values: <NRf>(Hz) | MAXimum | MINimum

*RST sets: 1 kHz

[SOURce]:FREQuency:SWEep:STEP[:LINear]?

Description: Queries the size of linear carrier sweep steps.

Parameters: None

Response: <NR2>

Returned values: Sweep step size in Hz

[SOURce]:FREQuency:SWEep:STEP:LOGarithmic

Description: Sets the size of logarithmic carrier sweep steps.

Parameters: <numeric_value>

Valid values: <NRf>(PCT) | MAXimum | MINimum

*RST sets: 1 PCT

[SOURce]:FREQuency:SWEep:STEP[:LOGarithmic]?

Description: Queries the size of logarithmic carrier sweep steps.

Parameters: None

Response: <NR2>

Returned values: Sweep step size as a percentage

[SOURce]:FREQuency:SWEep:STOP

Description: Sets the stop frequency for the carrier sweep.

Parameters: <numeric_value>

Valid values: <NRf>(Hz) | MAXimum | MINimum

*RST sets: MAX

[SOURce]:FREQuency:SWEep:STOP?

Description: Queries the carrier sweep's stop frequency.

Parameters: None

Response: <NR2>

Returned values: Sweep stop frequency in Hz

List commands

([SOURce]:LIST subsystem)

List mode sweep handling and triggering

Commands for:

- Controlling operation of a list mode frequency or power sweep
- Setting the sweep trigger mode.

[SOURce]

:LIST

:ABORt

:CALCulate

:CLEAr

:ALL

:TEND

:CONTInue

:DELeTe

:DWELI?

:FREQuency\?

:INITiate

:INSert

:OPERation\?

:PAUSE

:POWER\?

:RESet

:STARt\?

:STOP\?

:TRIGger\?

:SLOPe\?

:VALue\?

[SOURce]:LIST

Description: Inserts a sequence of frequency and power values into the list in sequence, starting at the address given.

Parameters: <NRf>,<NRf>,<NRf>[,<NRf>,<NRf>...]

Valid values: <addr>,<freq>,<power>[,<freq>,<power>...] <addr> is an integer within the address range of the list

[SOURce]:LIST:ABORt

Description: Stops the list sweep immediately.

Parameters: None

[SOURce]:LIST:CALCulate

Description: Calculate hardware settings for list frequencies and powers.

Parameters: None

[SOURce]:LIST:CLEAr

Description: Clears the entry at this address.

Parameters: <NRf>

Valid values: <addr>, an integer within the address range of the list

[SOURce]:LIST:CLEAr:ALL

Description: Clears all entries in the list.

Parameters: None

Valid values: None

[SOURce]:LIST:CLEAr:TEND

Description: Clears all entries from this address to the end of the list.

Parameters: <NRf>

Valid values: <addr>, an integer within the address range of the list

[SOURce]:LIST:CONTInue

Description: Continues a paused list sweep.

Parameters: None

[SOURce]:LIST:DELeTe

Description: Deletes the list entry at this address, shifting all following entries up.

Parameters: <NRf>

Valid values: <addr>, an integer within the address range of the list

[SOURce]:LIST:DWELl

Description: Sets the dwell time, the time spent at each address in the list.

Parameters: <NRf>

Valid values: <time (s)>

[SOURce]:LIST:DWELl?

Description: Returns the dwell time.

Parameters: None

Response: <NR2>

Returned values: Dwell time in s

[SOURce]:LIST:FREQUency

Description: Inserts a sequence of frequencies into the list, starting at the address given.

If there is already a list entry starting at this address, the command overwrites the frequency value(s) but does not modify the power value(s). If entries are not yet defined, the current power (specified by :SOURce:POWer?) is set as the power value.

Parameters: <NRf>,<NRf>[,<NRf>...]

Valid values: <addr>,<freq>[,<freq>...] <addr> is an integer within the address range of the list

[SOURce]:LIST:FREQUency?

Description: Returns the frequency at a specified list address.

Parameters: <addr>

Response: <NR1>

Returned values: Frequency in Hz

[SOURce]:LIST:INITiate

Description: Starts a list sweep.

Parameters: None

[SOURCE]:LIST:INSert

Description: Inserts frequency and power values into the list at this address, shifting all following entries down.

Parameters: <NRf>,<NRf>,<NRf>

Valid values: <addr>,<frequency>,<power> <addr> is an integer within the address range of the list

[SOURCE]:LIST:OPERation

Description: Sets whether the list sweep mode is single or continuous.

Parameters: <CPD>

Valid values: SINGLE | CONTInuous

*RST sets: SING

[SOURCE]:LIST:OPERation?

Description: Returns whether the list sweep mode is single or continuous.

Parameters: None

Response: <CRD>

Returned values: SING | CONT

[SOURCE]:LIST:PAUSE

Description: Pauses the list sweep.

Parameters: None

[SOURce]:LIST:POWER

Description: Inserts a sequence of powers into the list, starting at the address given.

If there is already a list entry starting at this address, the command overwrites the power value(s) but does not modify the frequency value(s). If entries are not yet defined, the current frequency (specified by :SOURce:FREQuency?) is set as the frequency value.

Parameters: <NRf>,<NRf>[,<NRf>...]

Valid values: <addr>,<power>[,<power>...] <addr> is an integer within the address range of the list

[SOURce]:LIST:POWER?

Description: Returns the power at a specified list address.

Parameters: <addr>

Response: <NR1>

Returned values: Power in dBm

[SOURce]:LIST:RESEt

Description: Returns the list sweep to its start address.

Parameters: None

[SOURce]:LIST:STARt

Description: Defines the start address, from which the list sweep is executed.

Parameters: <NRf>

Valid values: <addr>, an integer within the address range of the list

*RST sets: 0

[SOURce]:LIST:STARt?

Description: Returns the start address, from which the list sweep is executed.

Parameters: None

Response: <addr>

Returned values: Start address

[SOURce]:LIST:STOP

Description: Defines the stop address, at which the list sweep halts.

Parameters: <NRf>

Valid values: <addr>, an integer within the address range of the list

*RST sets: Maximum list address

[SOURce]:LIST:STOP?

Description: Returns the stop address, at which the list sweep halts.

Parameters: None

Response: <addr>

Returned values: Stop address

[SOURce]:LIST:TRIGger

Description: Sets the trigger mode to off, start, start then stop, or step.

Parameters: <CPD>

Valid values: OFF | START | SSTOP | STEP

*RST sets: OFF

[SOURce]:LIST:TRIGger?

Description: Queries the trigger mode for the list sweep.

Parameters: None

Response: <CRD>

Returned values: OFF | STAR | SSTOP | STEP

[SOURce]:LIST:TRIGger:SLOPe

Description: Sets the polarity of the external trigger.

Parameters: <CPD>

Valid values: POSitive | NEGative

*RST sets: POS

[SOURce]:LIST:TRIGger:SLOPe?

Description: Queries the polarity of the external trigger.

Parameters: None

Response: <CRD>

Returned values: POS | NEG

[SOURce]:LIST:VALue

Description: Modifies the frequency and power values at the specified address.

Parameters: <NRf>,<NRf>,<NRf>

Valid values: <addr>,<freq>,<power>

[SOURce]:LIST:VALue?

Description: Returns the frequency and power values at the specified address.

Parameters: None

Response: <NR1>,<NR2>,<NR2>

Returned values: Address and the associated frequency and power values

C

C

C

D

AM commands

([SOURce][:MODulation]:AM subsystem)

AM depth, source, frequency, waveshape, mod. sweep, phase, input parameters

Commands for:

- Setting AM frequency and frequency step size
- Setting AM depth and depth step size
- Setting AM coupling, impedance and sensitivity
- Setting AM mode (fixed or sweep)
- Setting AM waveshape and time per sweep
- Setting AM sweep parameters
- Setting internal/external source on/off
- Setting phase relationship of AM2 with respect to AM1.

[SOURce]
 [:MODulation]
 :AM[1]|2
 [:DEPTH]\?
 :STEP
 [:INCRement]\?
 :EXTernal
 :COUPLing\
 :IMPedance\
 :SENSitivity\
 :INTernal
 :FREQUency\
 [:FIXed]
 :STEP
 [:INCRement]\?
 :MODE\
 :SWEep
 :DWELI\
 :MANual\
 :SPACing\
 :STARt\
 :STEP
 [:LINear]\?
 :LOGarithmic\
 :STOP\
 :SHAPE\
 :SOURcel\
 :STATel\
 :AM2
 :INTernal
 :PHASel\
 :SENSitivity\

[SOURCE][:MODulation]:AM[1]|2[:DEPTH]

Description: Sets the AM depth as a percentage.

Parameters: <numeric_value>

Valid values: <NRf>(PCT) | MAXimum | MINimum | UP | DOWN | RETURN | REFERENCE

Set by value, to maximum or minimum, stepping up or down, returning to the last full setting, or setting the current value to the last full setting.

*RST sets: MIN

[SOURCE][:MODulation]:AM[1]|2[:DEPTH]?

Description: Queries the AM depth.

Parameters: None

Response: <NR2>

Returned values: AM depth as a percentage

[SOURCE][:MODulation]:AM[1]|2[:DEPTH]:STEP[:INCRement]

Description: Sets the AM depth step size as a percentage.

Parameters: <numeric_value>

Valid values: <NRf>(PCT) | MAXimum | MINimum

*RST sets: 1 PCT

[SOURCE][:MODulation]:AM[1]|2[:DEPTH]:STEP[:INCRement]?

Description: Queries the AM depth step size.

Parameters: None

Response: <NR2>

Returned values: AM depth step size as a percentage

[SOURCE]:MODulation:AM[1]2:EXTernal:COUPling

Description: Selects AC or DC coupling for the external source.

Parameters: <CPD>

Valid values: AC | DC

*RST sets: AC

[SOURCE]:MODulation:AM[1]2:EXTernal:COUPling?

Description: Queries whether the external source is AC- or DC-coupled.

Parameters: None

Response: <CRD>

Returned values: AC | DC

[SOURCE]:MODulation:AM[1]2:EXTernal:IMPedance

Description: Selects the impedance of the external source input — 50 Ω or 100 k Ω .

Parameters: <CPD>

Valid values: Z50 | K100

*RST sets: Z50 (in SCPI mode) or K100 (in 202x emulation).

[SOURCE]:MODulation:AM[1]2:EXTernal:IMPedance?

Description: Queries the impedance of the external source input.

Parameters: None

Response: <CRD>

Returned values: Z50 | K100

[SOURce][:MODulation]:AM[1]|2:EXTernal:SENSitivity

Description: Selects the sensitivity of the external source input for AM — 1 V RMS or 1 V peak.

Parameters: <CPD>

Valid values: VRMS | VPK

*RST sets: VRMS

[SOURce][:MODulation]:AM[1]|2:EXTernal:SENSitivity?

Description: Queries the sensitivity of the external source input for AM.

Parameters: None

Response: <CRD>

Returned values: VRMS | VPK

[SOURce][:MODulation]:AM[1]|2:INTernal:FREQuency[:FIXed]

Description: Sets the internal AM frequency.

Parameters: <numeric_value>

Valid values: <NRf>(Hz) | MAXimum | MINimum | UP | DOWN | RETurn | REFerence

Set by value, to maximum or minimum, stepping up or down, returning to the last full setting, or setting the current value to the last full setting.

*RST sets: AM1 = 1 kHz, AM2 = 400 Hz

[SOURce][:MODulation]:AM[1]|2:INTernal:FREQuency[:FIXed]?

Description: Queries the internal AM frequency.

Parameters: None

Response: <NR2>

Returned values: AM frequency in Hz

**[SOURce][:MODulation]:AM[1]|2:INTernal:FREQUENCY[:FIXed]
:STEP[:INCRement]**

Description: Sets the internal AM frequency step.

Parameters: <numeric_value>

Valid values: <NRf>(Hz) | MAXimum | MINimum

*RST sets: 10 Hz

**[SOURce][:MODulation]:AM[1]|2:INTernal:FREQUENCY[:FIXed]
:STEP[:INCRement]?**

Description: Queries the internal AM frequency step size.

Parameters: None

Response: <NR2>

Returned values: AM frequency step size in Hz

[SOURce][:MODulation]:AM[1]|2:INTernal:FREQUENCY:MODE

Description: Sets the mode of the AM frequency operation.

Parameters: <CPD>

Valid values: FIXed | SWEEp

*RST sets: FIXed

[SOURce][:MODulation]:AM[1]|2:INTernal:FREQUENCY:MODE?

Description: Queries the mode of the AM frequency operation (fixed or sweep).

Parameters: None

Response: <CRD>

Returned values: FIX | SWE

[SOURce][:MODulation]:AM[1]2:INTernal:FREQuency:SWEep :DWELI

Description: Sets the time per sweep step for AM.

Parameters: <numeric_value>

Valid values: <NRf>(ms) | MAXimum | MINimum

*RST sets: 50 ms

[SOURce][:MODulation]:AM[1]2:INTernal:FREQuency:SWEep :DWELI?

Description: Queries the time per sweep step for AM.

Parameters: None

Response: <NR2>

Returned values: Dwell time in ms

[SOURce][:MODulation]:AM[1]2:INTernal:FREQuency:SWEep :MANual

Description: Sets a new AM frequency whilst a sweep is paused.

Parameters: <numeric_value>

Valid values: <NRf>(Hz) | MAXimum | MINimum | UP | DOWN

Set by value, to maximum or minimum, or stepping up or down.

This command is available only when AM[1]2:INTernal:MODE SWEep is selected, and sweep operation is not in progress (PAUSED or WAITING FOR TRIGGER). The frequency value should be limited to the range determined by AM[1]2:INTernal:SWEep:STARt and AM[1]2:INTernal:SWEep:STOP.

[SOURce][:MODulation]:AM[1]2:INTernal:FREQuency:SWEep :MANual?

Description: Queries the AM frequency set during a paused sweep.

Parameters: None

Response: <NR2>

Returned values: AM frequency in Hz

**[SOURCE]:MODulation:AM[1]|2:INTERNAL:FREQUENCY:SWEEP
:SPACING**

Description: Sets the mode of sweep spacing for AM.

Parameters: <CPD>

Valid values: LINear | LOGarithmic

*RST sets: LIN

**[SOURCE]:MODulation:AM[1]|2:INTERNAL:FREQUENCY:SWEEP
:SPACING?**

Description: Queries the mode of sweep spacing for AM.

Parameters: None

Response: <CRD>

Returned values: LIN | LOG

**[SOURCE]:MODulation:AM[1]|2:INTERNAL:FREQUENCY:SWEEP
:START**

Description: Sets the start frequency for the AM sweep.

Parameters: <numeric_value>

Valid values: <freq>(Hz) | MAXimum | MINimum

*RST sets: MIN

**[SOURCE]:MODulation:AM[1]|2:INTERNAL:FREQUENCY:SWEEP
:START?**

Description: Queries the start frequency for the AM sweep.

Parameters: None

Response: <NR2>

Returned values: AM sweep start frequency in Hz

**[SOURce][:MODulation]:AM[1]|2:INTernal:FREQuency:SWEep
:STEP[:LINear]**

Description: Sets the size of the step for linear AM sweeps.

Parameters: <numeric_value>

Valid values: <freq>(Hz) | MAXimum | MINimum

*RST sets: 1 kHz

**[SOURce][:MODulation]:AM[1]|2:INTernal:FREQuency:SWEep
:STEP[:LINear]?**

Description: Queries the size of the step for linear AM sweeps.

Parameters: None

Response: <NR2>

Returned values: Linear sweep step size in Hz

**[SOURce][:MODulation]:AM[1]|2:INTernal:FREQuency:SWEep
:STEP:LOGarithmic**

Description: Sets the size of the step for logarithmic AM sweeps as a percentage.

Parameters: <numeric_value>

Valid values: <NRf>(PCT) | MAXimum | MINimum

*RST sets: 1 PCT

**[SOURce][:MODulation]:AM[1]|2:INTernal:FREQuency:SWEep
:STEP:LOGarithmic?**

Description: Queries the size of the step for logarithmic AM sweeps.

Parameters: None

Response: <NR2>

Returned values: Logarithmic sweep step size as a percentage

[SOURce][:MODulation]:AM[1]|2:INTernal:FREQuency:SWEep:STOP

Description: Sets the stop frequency for the AM sweep.

Parameters: <numeric_value>

Valid values: <NRf>(Hz) | MAXimum | MINimum

*RST sets: MAX

[SOURce][:MODulation]:AM[1]|2:INTernal:FREQuency:SWEep:STOP?

Description: Queries the stop frequency for the AM sweep.

Parameters: None

Response: <NR2>

Returned values: AM sweep stop frequency in Hz

[SOURce][:MODulation]:AM[1]|2:INTernal:SHAPe

Description: Selects the shape of the internally-generated AM waveform.

Parameters: <CPD>

Valid values: SINE | SQUare | TRIangle | RAMP

*RST sets: SINE

[SOURce][:MODulation]:AM[1]|2:INTernal:SHAPe?

Description: Queries the shape of the internally generated AM.

Parameters: None

Response: <CRD>

Returned values: SINE | SQU | TRI | RAMP

[SOURCE][:MODulation]:AM[1]|2:SOURCE

Description: Selects either an internal or external source to generate AM.

Parameters: <CPD>

Valid values: INTernal | EXTernal

*RST sets: INT

[SOURCE][:MODulation]:AM[1]|2:SOURCE?

Description: Queries whether the source for AM is internal or external.

Parameters: None

Response: <CRD>

Returned values: INT | EXT

[SOURCE][:MODulation]:AM[1]|2:STATE

Description: Adds AM1 or AM2 to the set of active modulations, or removes AM1 or AM2 from it: see Fig. 4-1 on page 4-19.

Parameters: <Boolean>

Valid values: OFF | ON | 0 | 1

*RST sets: OFF

[SOURCE][:MODulation]:AM[1]|2:STATE?

Description: Queries whether the AM path is on (1) or off (0).

Parameters: None

Response: <Boolean>

Returned values: 0 | 1

[SOURce][:MODulation]:AM2:INTernal:PHASe

Description: Sets the phase offset of AM2 relative to AM1.

Parameters: <numeric_value>

Valid values: <NRf> | UP | DOWN

*RST sets: 0

[SOURce][:MODulation]:AM2:INTernal:PHASe?

Description: Queries the phase offset of AM2 relative to AM1.

Parameters: None

Response: <NR2>

Returned values: Phase angle (degrees)

[SOURce][:MODulation]:AM2:INTernal:PHASe:SENSitivity

Description: Selects the sensitivity of the rotary control or $\left(\begin{smallmatrix} \times 10 \\ \downarrow \end{smallmatrix}\right)$ and $\left(\begin{smallmatrix} \div 10 \\ \uparrow \end{smallmatrix}\right)$ keys when setting up the phase offset of AM2 relative to AM1.

Parameters: <CPD>

Valid values: FINE (0.01° resolution)
MEDIum (0.1° resolution)
COARse (1.0° resolution)

*RST sets: FINE

[SOURce][:MODulation]:AM2:INTernal:PHASe:SENSitivity?

Description: Queries the sensitivity of the rotary control or $\left(\begin{smallmatrix} \times 10 \\ \downarrow \end{smallmatrix}\right)$ and $\left(\begin{smallmatrix} \div 10 \\ \uparrow \end{smallmatrix}\right)$ keys when setting up the phase offset of AM2 relative to AM1.

Parameters: None

Response: <CRD>

Returned values: FIN | MED | COAR

Burst commands

([SOURce][:MODulation]:BURst subsystem)

Burst source, rise and fall times, attenuation, position

Commands for:

- Setting burst control parameters.

[SOURce]	
[:MODulation]	
:BURSt	
:EXTeRnal	
:ALTeRnate	Set burst...
:ATTenuation\?	...attenuation
:STATe\?	...control bit
[:DEFine]	
:DDELta\?	...'on' time
:FTIMe\?	...fall time
:OFFSet\?	...positioning
:PROFile\?	...profile
:RTIMe\?	...rise time
:TINTerval\?	...trigger interval
:INTeRnal	
:ALTeRnate	
:ATTenuation\?	
:STATe\?	
:TRANsition	
:CLEar	
[:TEND]	Clear transition points
:LIST\?	List transition points
:REPeat\?	Burst marker repeat length
[:DEFine]	
:DDELta\?	
:FTIMe\?	
:OFFSet\?	
:PROFile\?	
:RTIMe\?	
:TINTerval\?	
:TRANsition	
:CLEar	
[:TEND]	
:LIST\?	
:REPeat\?	
:SOURce\?	Source for burst control
:STATe\?	Burst source on/off

[SOURce][:MODulation]:BURSt:EXTErnal:ALTErnate:ATTenuation

Description: Sets attenuation to decrease the RF level from the nominal value.

Parameters: <numeric_value>

Valid values: <NRf>(dB) | MAXimum | MINimum

*RST sets: MINimum

[SOURce][:MODulation]:BURSt:EXTErnal:ALTErnate:ATTenuation?

Description: Queries the attenuation setting.

Parameters: None

Response: <NR2>

Returned values: Level in dB

[SOURce][:MODulation]:BURSt:EXTErnal:ALTErnate:STATE

Description: Sets the state of the attenuation control bit for dual burst control.

Parameters: <Boolean>

Valid values: OFF | ON | 0 | 1

*RST sets: OFF

[SOURce][:MODulation]:BURSt:EXTErnal:ALTErnate:STATE?

Description: Queries the state of the attenuation control bit for dual burst control.

Parameters: None

Response: <NR1>

Returned values: 0 | 1

[SOURCE][:MODulation]:BURSt:EXTErnal[:DEFine]:DDELta

Description: Sets the burst duration delta, which modifies the burst length ('on' time).

Parameters: <numeric_value>

Valid values: <NRf>(s) | MAXimum | MINimum

*RST sets: 0.0 μ s

[SOURCE][:MODulation]:BURSt:EXTErnal[:DEFine]:DDELta?

Description: Queries the burst length.

Parameters: None

Response: <NR2>

Returned values: Time in seconds

[SOURCE][:MODulation]:BURSt:EXTErnal[:DEFine]:FTIME

Description: Sets the burst fall time

Parameters: <numeric_value>

Valid values: <NRf>(s) | MAXimum | MINimum

*RST sets: MINimum

[SOURCE][:MODulation]:BURSt:EXTErnal[:DEFine]:FTIME?

Description: Queries the burst fall time.

Parameters: None

Response: <NR2>

Returned values: Time in seconds

[SOURce][:MODulation]:BURSt:EXTernal[:DEFine]:OFFSet

Description: Sets the burst offset, which positions the burst with respect to the Marker 1 or external trigger input.

Parameters: <numeric_value>

Valid values: <NRf>(s) | MAXimum | MINimum

*RST sets: 0.0 μ s

[SOURce][:MODulation]:BURSt:EXTernal[:DEFine]:OFFSet?

Description: Queries the burst offset.

Parameters: None

Response: <NR2>

Returned values: Time in seconds

[SOURce][:MODulation]:BURSt:EXTernal[:DEFine]:PROFFile

Description: Sets the burst profile.

Parameters: <CPD>

Valid values: <NONE> | COSine | GAUSSian

*RST sets: COSine

[SOURce][:MODulation]:BURSt:EXTernal[:DEFine]:PROFFile?

Description: Queries the burst profile.

Parameters: None

Response: <CRD>

Returned values: NONE | COS | GAUS

[SOURce][:MODulation]:BURSt:EXTernal[:DEFine]:RTIME

Description: Sets the burst rise time.

Parameters: <numeric_value>

Valid values: <NRf>(s) | MAXimum | MINimum

*RST sets: MINimum

[SOURce][:MODulation]:BURSt:EXTernal[:DEFine]:RTIME?

Description: Queries the burst rise time.

Parameters: None

Response: <NR2>

Returned values: Time in seconds.

[SOURce][:MODulation]:BURSt:EXTernal[:DEFine]:TINTerval

Description: Sets the burst trigger interval, the time taken for the output power to settle at the user-defined level after the Marker 1/external trigger input.

Parameters: <numeric_value>

Valid values: <NRf>(s) | MAXimum | MINimum

*RST sets: 1.5 x rise time, minimum

[SOURce][:MODulation]:BURSt:EXTernal[:DEFine]:TINTerval?

Description: Queries the burst trigger interval.

Parameters: None

Response: <NR2>

Returned values: Time in seconds.

[SOURCE][:MODulation]:BURSt:INTernal:ALTernate:ATTenuation

Description: Sets attenuation to decrease the RF level from the nominal value.

Parameters: <numeric_value>

Valid values: <NRf>(dB) | MAXimum | MINimum

*RST sets: MINimum

[SOURCE][:MODulation]:BURSt:INTernal:ALTernate:ATTenuation?

Description: Queries the attenuation setting.

Parameters: None

Response: <NR2>

Returned values: Level in dB

[SOURCE][:MODulation]:BURSt:INTernal:ALTernate:STATE

Description: Sets the state of the attenuation control bit.

Parameters: <Boolean>

Valid values: OFF | ON | 0 | 1

*RST sets: OFF

[SOURCE][:MODulation]:BURSt:INTernal:ALTernate:STATE?

Description: Queries the state of the attenuation control bit.

Parameters: None

Response: <NR1>

Returned values: 0 | 1

**[SOURCE][:MODulation]:BURSt:INTernal:ALTernate:TRANSition
:CLEar[:TEND]**

Description: Clears the alternate level marker transition points from this point to the end of the list.
If no value is entered, 0 is assumed, which clears all.

Applies only to instruments fitted with RTBB, Option 008.

Parameters: <numeric_value>

Valid values: <NRf> | MAXimum | MINimum

[SOURce][:MODulation]:BURSt:INTernal:ALTErnate:TRANSition:LIST

Description: Transition points are measured in symbols (the 'offset') from the preceding point. The status of the alternate level marker changes at each transition point, starting at LOW level. Setting any offset except the first to 0 causes remaining arguments to be set to 0 and ignored. Setting the first transition point to 0 causes a transition to HIGH level on the first symbol. See Fig. 4-2 for an example.

This command applies only to instruments fitted with RTBB, Option 008.

Parameters: <NRf>,<NRf>[<NRf>...]

Valid values: StartTransitionPoint,tp1[,tp2...,tp16]

*RST sets: All 0s

Example: :BURS:INT:ALT:TRAN:LIST 1,5,5,990,10,10,5,975,2,0

[SOURce][:MODulation]:BURSt:INTernal:ALTErnate:TRANSition:LIST?

Description: Queries the alternate level transition points.

Parameters: None

Response: <NR1>,<NR1>[,<NR1...<NR1>]

Returned values: Offsets in symbols

Example: :BURS:INT:ALT:TRAN:LIST? 1,5,5,990,10,10,5,975,2,0

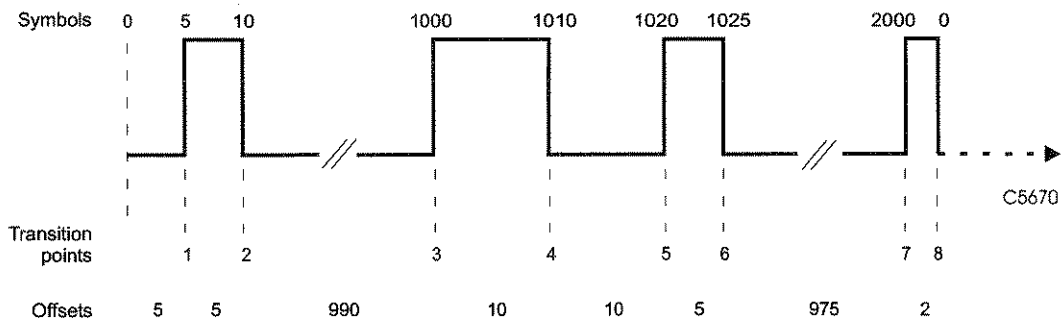

Fig. 4-2 Transition points and offsets

[SOURCE][:MODulation]:BURSt:INTernal:ALTErnate:TRANsition:REPeat

Description: Sets the repeat length of the alternate level burst marker. See Fig. 4-3 for an example.

Parameters: <numeric_value>

Valid values: <NRf>(transitions) | MAXimum | MINimum

*RST sets: 0

Example: :BURS:INT:ALT:TRAN:REP 4

[SOURCE][:MODulation]:BURSt:INTernal:ALTErnate:TRANsition:REPeat?

Description: Queries the repeat length of the alternate level burst marker.

Parameters: None

Response: <NR1>

Returned values: Repeat length in transitions

Example: :BURS:INT:ALT:TRAN:REP? 4

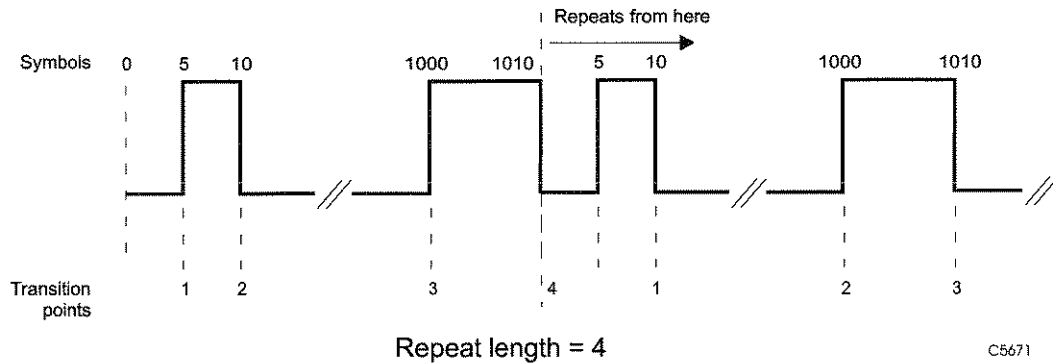

Fig. 4-3 Repeat length

[SOURCE][:MODulation]:BURSt:INTernal[:DEFine]:DDELta

Description: Sets the burst duration delta, which modifies the burst length ('on' time).

Parameters: <numeric_value>

Valid values: <NRf>(s) | MAXimum | MINimum

*RST sets: 0.0 μ s

[SOURCE][:MODulation]:BURSt:INTernal[:DEFine]:DDELta?

Description: Queries the burst length.

Parameters: None

Response: <NR2>

Returned values: Time in seconds

[SOURCE][:MODulation]:BURSt:INTernal[:DEFine]:FTIME

Description: Sets the burst fall time

Parameters: <numeric_value>

Valid values: <NRf>(s) | MAXimum | MINimum

*RST sets: MINimum

[SOURCE][:MODulation]:BURSt:INTernal[:DEFine]:FTIME?

Description: Queries the burst fall time.

Parameters: None

Response: <NR2>

Returned values: Time in seconds

[SOURce][:MODulation]:BURSt:INTernal[:DEFine]:OFFSet

Description: Sets the burst offset, which positions the burst with respect to the Marker 1 or external trigger input.

Parameters: <numeric_value>

Valid values: <NRf>(s) | MAXimum | MINimum

*RST sets: 0.0 μ s

[SOURce][:MODulation]:BURSt:INTernal[:DEFine]:OFFSet?

Description: Queries the burst offset.

Parameters: None

Response: <NR2>

Returned values: Time in seconds

[SOURce][:MODulation]:BURSt:INTernal[:DEFine]:PROFile

Description: Sets the burst profile.

Parameters: <CPD>

Valid values: <NONE> | COSine | GAUSSian

*RST sets: COSine

[SOURce][:MODulation]:BURSt:INTernal[:DEFine]:PROFile?

Description: Queries the burst profile.

Parameters: None

Response: <CRD>

Returned values: NONE | COS | GAUS

[SOURCE][:MODulation]:BURSt:INTernal[:DEFine]:RTIME

Description: Sets the burst rise time.

Parameters: <numeric_value>

Valid values: <NRf>(s) | MAXimum | MINimum

*RST sets: MINimum

[SOURCE][:MODulation]:BURSt:INTernal[:DEFine]:RTIME?

Description: Queries the burst rise time.

Parameters: None

Response: <NR2>

Returned values: Time in seconds

[SOURCE][:MODulation]:BURSt:INTernal[:DEFine]:TINTerval?

Description: Queries the burst trigger interval, the time taken for the output power to settle at the user-defined level after the Marker 1/burst gate line is asserted.

Parameters: None

Response: <NR1>

Returned values: Time in seconds

[SOURCE][:MODulation]:BURSt:INTernal:TRANSition:CLEar[:TEND]

Description: Clears the burst marker transition points from this point up to the end of the list. If no value is entered, 0 is assumed, which clears all.

Applies only to instruments fitted with RTBB, Option 008.

Parameters: <numeric_value>

Valid values: <NRf>

[SOURce][:MODulation]:BURSt:INTernal:TRANSition :LIST

Description: Transition points are measured in symbols (the 'offset') from the preceding point. The status of the burst marker changes at each transition point, starting at LOW level. Setting any offset except the first to 0 causes remaining arguments to be set to 0 and ignored. Setting the first transition point to 0 causes a transition to HIGH level on the first symbol. See Fig. 4-2 on page 4-68 for an example.

Applies only to instruments fitted with RTBB, Option 008.

Parameters: <NRf>,<NRf>[<NRf>...]

Valid values: StartTransitionPoint,tp1[,tp2,...,tp16]

*RST sets: All 0s

Example: :BURS:INT:TRAN:LIST 1,5,5,990,10,10,5,975,2,0

[SOURce][:MODulation]:BURSt:INTernal:TRANSition :LIST?

Description: Queries the burst transition points.

Parameters: None

Response: <NR1>,<NR1>[,<NR1...<NR1>]

Returned values: Offsets in symbols

Example: :BURS:INT:TRAN:LIST? 1,5,5,990,10,10,5,975,2,0

[SOURce][:MODulation]:BURSt:INTernal:TRANSition:REPeat

Description: Sets the repeat length of the burst marker. See Fig. 4-3 on page 4-69 for an example.

Parameters: <numeric_value>

Valid values: <NRf>(transitions) | MAXimum | MINimum

*RST sets: 0

Example: :BURS:INT:TRAN:REP 4

[SOURce][:MODulation]:BURSt:INTernal:TRANSition:REPeat?

Description: Queries the repeat length of the burst marker.

Parameters: None

Response: <NR1>

Returned values: Repeat length in transitions

Example: :BURS:INT:TRAN:REP? 4

[SOURce][:MODulation]:BURSt:SOURce

Description: Selects the source for burst control.

Parameters: <CPD>

Valid values: EXTernal | INTernal

EXT is the rear-panel BURST GATE IN connector.

INT is the Marker 1 control bit from the ARB.

*RST sets: EXTernal

[SOURce][:MODulation]:BURSt:SOURce?

Description: Queries the source for burst control.

Parameters: None

Response: <CRD>

Returned values: EXT | INT

[SOURce][:MODulation]:BURSt:STATe

Description: Adds Burst to the set of active modulations, or removes Burst from it: see Fig. 4-1 on page 4-19.

Parameters: <Boolean>

Valid values: OFF | ON | 0 | 1

*RST sets: OFF

[SOURce][:MODulation]:BURSt:STATe?

Description: Queries whether the Burst path is on (1) or off (0).

Parameters: None

Response: <Boolean>

Returned values: 0 | 1

Frequency hopping commands

([SOURce][:MODulation]:FHOPping subsystem)

List handling, operating modes, marker setup, source settings

Commands for:

- Setting frequency hopping points
- Setting operating mode
- Setting marker transition points and repeat length
- Setting and enabling the frequency hopping source

```
[SOURce]
  [:MODulation]
    :FHOPping
      :FLIST
        :CLEAr
          :ALL
            [:TEND]
              Clear transition points
        :DELeTe
        :INSert
        [:VALue]?
      :INTernal
        :LINear
          :ADDRes\?
          :LENGTh\?
        :OPERation\?
        :RANDom
        :TRANSition
          :CLEAr
            [:TEND]
          :LIST\?
          :REPeat\?
      :SOURce\?
      :STATe\?
        Source for f'hop control
        F'hop source on/off
```

[SOURce][:MODulation]:FHOPping:FLIS:CLEar:ALL

Description: Clears the frequency hopping list.

Parameters: None

Valid values: None

[SOURce][:MODulation]:FHOPping:FLIS:CLEar[:TEND]

Description: Clears the hopping frequency list points from this address to the end of the list.

Parameters: <numeric_value>

Valid values: <NRf>

[SOURce][:MODulation]:FHOPping:FLIS:DELEte

Description: Deletes the hopping frequency point at this address.

Parameters: <NRf>

Valid values: <addr>

[SOURce][:MODulation]:FHOPping:FLIS:INSert

Description: Inserts a hopping frequency point into the list at this address.

Parameters: <NRf>,<NRf>

Valid values: <addr>,<offset>

[SOURce][:MODulation]:FHOPping:FLIS[:VALue]

Description: Inserts a sequence of frequencies starting at the address given.

Parameters: <NRf>,<NRf>[,<NRf>...]

Valid values: <addr>,<offset>[,<offset>...]

[SOURce][:MODulation]:FHOPping:FLIS[:VALue]?

Description: Returns the addresses and values in the frequency hopping list.

Parameters: None

Response: <NR1>,<NR2>[,<NR1>,<NR2>...]

Returned values: Addresses and their associated offsets

[SOURce][:MODulation]:FHOPping:INTernal:LINEar:ADDRESS

Description: Start address for linear hopping in the hop table.

Parameters: <NRf>

Valid values: <NRf> | MAXimum | MINimum

*RST sets: 0

[SOURce][:MODulation]:FHOPping:INTernal:LINEar:ADDRESS?

Description: Returns the start address for linear hopping in the hop table.

Parameters: None

Response: <addr>

Returned values: <NR1> | MAX | MIN

[SOURce][:MODulation]:FHOPping:INTernal:LINEar:LENGTH

Description: Length of the linear hopping sequence in the hop table.

Parameters: <NRf>

Valid values: <NRf> | MAXimum | MINimum

*RST sets: MAX

[SOURce][:MODulation]:FHOPping:INTernal:LINEar:LENGTH?

Description: Returns the length of the linear hopping sequence in the hop table.

Parameters: None

Response: <addr>

Returned values: <NR1> | MAX | MIN

[SOURCE][:MODulation]:FHOPping:INTernal:OPERation

Description: Sets whether the frequency hopping mode is linear or random.

Parameters: <CPD>

Valid values: LINear | RANDom

*RST sets: LINear

[SOURCE][:MODulation]:FHOPping:INTernal:OPERation?

Description: Returns whether the frequency hopping mode is linear or random.

Parameters: None

Response: <CRD>

Returned values: LIN | RAND

[SOURCE][:MODulation]:FHOPping:INTernal:RANDom[:PNCcode]

Description: Sets the PN code for frequency hopping.

Parameters: <CPD>

Valid values: PN9 | PN11 | PN15 | PN16 | PN20 | PN21 | PN23

*RST sets:

[SOURCE][:MODulation]:FHOPping:INTernal:TRANSition:CLEar[:TEND]

Description: Clears the frequency hopping marker transition points from this point up to the end of the list. If no value is entered, 0 is assumed, which clears all.

Applies only to instruments fitted with RTBB, Option 008.

Parameters: <numeric_value>

Valid values: <NRf>

[SOURce][:MODulation]:FHOPping:INTernal:TRANSition:LIST

Description: Transition points are measured in symbols (the 'offset') from the preceding point. The status of the frequency hopping marker changes at each transition point, starting at LOW level. Setting any offset except the first to 0 causes remaining arguments to be set to 0 and ignored. Setting the first transition point to 0 causes a transition to HIGH level on the first symbol. See Fig. 4-2 on page 4-68 for an example.

Applies only to instruments fitted with RTBB, Option 008.

Parameters: <NRf>,<NRf>[<NRf>...]

Valid values: StartTransitionPoint,tp1[,tp2...,tp16]

*RST sets: All 0s

Example: :FHOP:INT:TRAN:LIST 1,5,5,990,10,10,5,975,2,0

[SOURce][:MODulation]:FHOPping:INTernal:TRANSition:LIST?

Description: Queries the frequency hopping transition points.

Parameters: None

Response: <NR1>,<NR1>[,<NR1>...<NR1>]

Returned values: Offsets in symbols

Example: :FHOP:INT:TRAN:LIST? 1,5,5,990,10,10,5,975,2,0

[SOURce][:MODulation]:FHOPping:INTernal:TRANSition:REPeat

Description: Sets the repeat length of the frequency hopping marker. See Fig. 4-3 on page 4-69 for an example.

Parameters: <numeric_value>

Valid values: <NRf>(transitions) | MAXimum | MINimum

*RST sets: 0

Example: :FHOP:INT:TRAN:REP 4

[SOURce][:MODulation]:FHOPping:INTernal:TRANSition:REPeat?

Description: Queries the repeat length of the frequency hopping marker.

Parameters: None

Response: <NR1>

Returned values: Repeat length in transitions

Example: :FHOP:INT:TRAN:REP? 4

[SOURce][:MODulation]:FHOPping:SOURce

Description: Selects the source for frequency hopping control.

Parameters: <CPD>

Valid values: EXTERNAL | INTERNAL

*RST sets: INTERNAL

[SOURce][:MODulation]:FHOPping:SOURce?

Description: Queries the source for frequency hopping control.

Parameters: None

Response: <CRD>

Returned values: EXT | INT

[SOURce][:MODulation]:FHOPping:STATE

Description: Adds frequency hopping to the set of active modulations, or removes frequency hopping from it: see Fig. 4-1 on page 4-19.

Parameters: <Boolean>

Valid values: OFF | ON | 0 | 1

*RST sets: OFF

[SOURce][:MODulation]:FHOPping:STATE?

Description: Queries whether the frequency hopping path is on (1) or off (0).

Parameters: None

Response: <Boolean>

Returned values: 0 | 1

FM commands

([SOURce][:MODulation]:FM subsystem)

FM deviation, source, frequency, waveshape, mod. sweep, phase, input parameters, DC null

Commands for:

- Setting FM frequency and frequency step size
- Setting FM depth and depth step size
- Setting FM coupling, impedance and sensitivity
- Setting DC null
- Setting FM mode (fixed or sweep)
- Setting FM waveshape and time per sweep
- Setting FM sweep parameters
- Setting internal/external source on/off
- Setting phase relationship of FM2 with respect to FM1.

```
[SOURce]
  [:MODulation]
    :FM[1]|2
      [:DEViation]\?
        :STEP
          [:INCRement]\?
        :EXTernal
          :COUPling\?
          :DNULI
          :IMPedance\?
          :SENSitivity\?
        :INTernal
          :FREQuency\?
            [:FIXed]
              :STEP
                [:INCRement]\?
            :MODE\?
            :SWEep
              :DWELI\?
              :MANual\?
              :SPACing\?
              :STARt\?
              :STEP
                [:LINear]\?
                :LOGarithmic\?
            :STOP\?
          :SHAPe\?
        :SOURce\?
        :STATe\?
  :FM2
    :INTernal
      :PHASe\?
      :SENSitivity\?
```

[SOURce][:MODulation]:FM[1]|2[:DEViation]

Description: Sets the FM deviation.

Parameters: <numeric_value>

Valid values: <NRf>(Hz) | MAXimum | MINimum | UP | DOWN | RETurn | REFerence

Set by value, to maximum or minimum, stepping up or down, returning to the last full setting, or setting the current value to the last full setting.

*RST sets: MIN

[SOURce][:MODulation]:FM[1]|2[:DEViation]?

Description: Queries the FM deviation.

Parameters: None

Response: <NR2>

Returned values: FM deviation in Hz

[SOURce][:MODulation]:FM[1]|2[:DEViation]:STEP[:INCRement]

Description: Sets the FM deviation step size.

Parameters: <numeric_value>

Valid values: <NRf>(Hz) | MAXimum | MINimum

*RST sets: 1 kHz

[SOURce][:MODulation]:FM[1]|2[:DEViation]:STEP[:INCRement]?

Description: Queries the FM deviation step size.

Parameters: None

Response: <NR2>

Returned values: FM deviation step size in Hz

[SOURce][:MODulation]:FM[1]|2:EXTernal:COUPling

Description: Selects AC or DC coupling for the external source.

Parameters: <CPD>

Valid values: AC | DC

*RST sets: AC

[SOURce][:MODulation]:FM[1]|2:EXTernal:COUPling?

Description: Queries whether the external source is AC- or DC-coupled.

Parameters: None

Response: <CRD>

Returned values: AC | DC

[SOURce][:MODulation]:FM[1]|2:EXTernal:DNUL

Description: Performs a DC FM null.

Reminder: you need to apply a ground reference to the external modulation input.

Parameters: None

[SOURce][:MODulation]:FM[1]|2:EXTernal:IMPedance

Description: Selects the impedance of the external source input — 50 Ω or 100 k Ω .

Parameters: <CPD>

Valid values: Z50 | K100

*RST sets: Z50 (in SCPI mode) or K100 (in 202x emulation).

[SOURce][:MODulation]:FM[1]|2:EXTernal:IMPedance?

Description: Queries the impedance of the external source input.

Parameters: None

Response: <CRD>

Returned values: Z50 | K100

[SOURce][:MODulation]:FM[1]2:EXTernal:SENSitivity

Description: Selects the sensitivity of the external source input for FM — 1 V RMS or 1 V peak.

Parameters: <CPD>

Valid values: VRMS | VPK

*RST sets: VRMS

[SOURce][:MODulation]:FM[1]2:EXTernal:SENSitivity?

Description: Queries the sensitivity of the external source input for FM.

Parameters: None

Response: <CRD>

Returned values: VRMS | VPK

[SOURce][:MODulation]:FM[1]2:INTernal:FREQuency[:FIXed]

Description: Sets the internal FM frequency.

Parameters: <numeric_value>

Valid values: <NRf>(Hz) | MAXimum | MINimum | UP | DOWN | RETurn | REFerence

Set by value, to maximum or minimum, stepping up or down, returning to the last full setting, or setting the current value to the last full setting.

*RST sets: FM1 = 1 kHz, FM2 = 400 Hz

[SOURce][:MODulation]:FM[1]2:INTernal:FREQuency[:FIXed]?

Description: Queries the internal FM frequency.

Parameters: None

Response: <NR2>

Returned values: FM frequency in Hz

**[SOURce][:MODulation]FM[1]|2:INTernal:FREQuency[:FIXed]
:STEP[:INCRement]**

Description: Sets the internal FM frequency step.

Parameters: <numeric_value>

Valid values: <NRf>(Hz) | MAXimum | MINimum

*RST sets: 10 Hz

**[SOURce][:MODulation]:FM[1]|2:INTernal:FREQuency[:FIXed]
:STEP[:INCRement]?**

Description: Queries the internal FM frequency step size.

Parameters: None

Response: <NR2>

Returned values: FM frequency step size in Hz

[SOURce][:MODulation]:FM[1]|2:INTernal:FREQuency:MODE

Description: Sets the mode of the FM frequency operation.

Parameters: <CPD>

Valid values: FIXed | SWEep

*RST sets: FIXed

[SOURce][:MODulation]:FM[1]|2:INTernal:FREQuency:MODE?

Description: Queries the mode of the FM frequency operation (fixed or sweep).

Parameters: None

Response: <CRD>

Returned values: FIX | SWE

[SOURce][:MODulation]:FM[1]|2:INTernal:FREQuency:SWEep:DWEL

Description: Sets the time per sweep step for FM.

Parameters: <numeric_value>

Valid values: <NRf>(ms) | MAXimum | MINimum

*RST sets: 50 ms

[SOURce][:MODulation]:FM[1]|2:INTernal:FREQuency:SWEep:DWEL?

Description: Queries the time per sweep step for FM.

Parameters: None

Response: <NR2>

Returned values: Dwell time in ms

[SOURce][:MODulation]:FM[1]|2:INTernal:FREQuency:SWEep:MANual

Description: Sets a new FM frequency whilst a sweep is paused.

Parameters: <numeric_value>

Valid values: <NRf>(Hz) | MAXimum | MINimum | UP | DOWN

Set by value, to maximum or minimum, or stepping up or down.

This command is available only when FM[1]|2:INTernal:MODE SWEep is selected, and sweep operation is not in progress (PAUSED or WAITING FOR TRIGGER). The frequency value should be limited to the range determined by FM[1]|2:INTernal:SWEep:START and FM[1]|2:INTernal:SWEep:STOP.

[SOURce][:MODulation]:FM[1]|2:INTernal:FREQuency:SWEep:MANual?

Description: Queries the FM frequency set during a paused sweep.

Parameters: None

Response: <NR2>

Returned values: AM frequency in Hz

[SOURce][:MODulation]:FM[1]|2:INTernal:FREQuency:SWEep:SPACing

Description: Sets the mode of sweep spacing for FM.

Parameters: <CPD>

Valid values: LINear | LOGarithmic

*RST sets: LIN

[SOURce][:MODulation]:FM[1]|2:INTernal:FREQuency:SWEep:SPACing?

Description: Queries the mode of sweep spacing for FM.

Parameters: None

Response: <CRD>

Returned values: LIN | LOG

[SOURce][:MODulation]:FM[1]|2:INTernal:FREQuency:SWEep:START

Description: Sets the start frequency for the FM sweep.

Parameters: <numeric_value>

Valid values: <NRf>(Hz) | MAXimum | MINimum

*RST sets: MIN

[SOURce][:MODulation]:FM[1]|2:INTernal:FREQuency:SWEep:START?

Description: Queries the start frequency for the FM sweep.

Parameters: None

Response: <NR2>

Returned values: AM sweep start frequency in Hz

**[SOURce][:MODulation]:FM[1]|2:INTernal:FREQuency:SWEep
:STEP[:LINear]**

Description: Sets the size of the step for linear FM sweeps.

Parameters: <numeric_value>

Valid values: <NRf>(Hz) | MAXimum | MINimum

*RST sets: 1 kHz

**[SOURce][:MODulation]:FM[1]|2:INTernal:FREQuency:SWEep
:STEP[:LINear]?**

Description: Queries the size of the step for linear FM sweeps.

Parameters: None

Response: <NR2>

Returned values: Linear sweep step size in Hz

**[SOURce][:MODulation]:FM[1]|2:INTernal:FREQuency:SWEep
:STEP:LOGarithmic**

Description: Sets the size of the step for logarithmic FM sweeps as a percentage.

Parameters: <numeric_value>

Valid values: <NRf>(PCT) | MAXimum | MINimum

*RST sets: 1 PCT

**[SOURce][:MODulation]:FM[1]|2:INTernal:FREQuency:SWEep
:STEP:LOGarithmic?**

Description: Queries the size of the step for logarithmic FM sweeps.

Parameters: None

Response: <NR2>

Returned values: Logarithmic sweep step size as a percentage

[SOURce][:MODulation]:FM[1]|2:INTernal:FREQuency:SWEep:STOP

Description: Sets the stop frequency for the FM sweep.

Parameters: <numeric_value>

Valid values: <NRf>(Hz) | MAXimum | MINimum

*RST sets: MAX

[SOURce][:MODulation]:FM[1]|2:INTernal:FREQuency:SWEep:STOP?

Description: Queries the stop frequency for the FM sweep.

Parameters: None

Response: <NR2>

Returned values: FM sweep stop frequency in Hz

[SOURce][:MODulation]:FM[1]|2:INTernal:SHAPe

Description: Selects the shape of the internally generated FM.

Parameters: <CPD>

Valid values: SINE | SQUare | TRIangle | RAMP

*RST sets: SINE

[SOURce][:MODulation]:FM[1]|2:INTernal:SHAPe?

Description: Queries the shape of the internally generated FM.

Parameters: None

Response: <CRD>

Returned values: SINE | SQU | TRI | RAMP

[SOURCE][:MODulation]:FM[1]|2:SOURCE

Description: Selects either an internal or external source to generate FM.

Parameters: <CPD>

Valid values: INTernal | EXTernal

*RST sets: INT

[SOURCE][:MODulation]:FM[1]|2:SOURCE?

Description: Queries whether the source for FM is internal or external.

Parameters: None

Response: <CRD>

Returned values: INT | EXT

[SOURCE][:MODulation]:FM[1]|2:STATE

Description: Adds FM1 or FM2 to the set of active modulations, or removes FM1 or FM2 from it: see Fig. 4-1 on page 4-19.

Parameters: <Boolean>

Valid values: OFF | ON | 0 | 1

*RST sets: OFF

[SOURCE][:MODulation]:FM[1]|2:STATE?

Description: Queries whether the FM path is on (1) or off (0).

Parameters: None

Response: <Boolean>

Returned values: 0 | 1

[SOURCE][:MODulation]:FM2:INTernal:PHASE

Description: Sets the phase offset of FM2 relative to FM1.

Parameters: <numeric_value>

Valid values: <NRf> | UP | DOWN

*RST sets: 0

[SOURCE][:MODulation]:FM2:INTernal:PHASe?

Description: Queries the phase offset of FM2 relative to FM1.

Parameters: None

Response: <NR2>

Returned values: Phase angle (degrees)

[SOURCE][:MODulation]:FM2:INTernal:PHASe:SENSitivity

Description: Selects the sensitivity of the rotary control or $\left(\begin{smallmatrix} \times 10 \\ \downarrow \end{smallmatrix}\right)$ and $\left(\begin{smallmatrix} +10 \\ \uparrow \end{smallmatrix}\right)$ keys when setting up the phase offset of FM2 relative to FM1.

Parameters: <CPD>

Valid values: FINE (0.01° resolution)
 MEDIUM (0.1° resolution)
 COARSE (1.0° resolution)

*RST sets: FINE

[SOURCE][:MODulation]:FM2:INTernal:PHASe:SENSitivity?

Description: Queries the sensitivity of the rotary control or $\left(\begin{smallmatrix} \times 10 \\ \downarrow \end{smallmatrix}\right)$ and $\left(\begin{smallmatrix} +10 \\ \uparrow \end{smallmatrix}\right)$ keys when setting up the phase offset of FM2 relative to FM1.

Parameters: None

Response: <CRD>

Returned values: FIN | MED | COAR

IQ commands

([SOURce][:MODulation]:IQ subsystem)

IQ source parameters, digital filters, RTBB, differential IQ and ARB handling

Commands for:

- Setting external source impedance
- Setting digital filter parameters
- Controlling ARB generation
- Controlling RTBB generation
- Setting up differential IQ outputs
- Setting IQ internal/external source on/off
- Setting internal baseband source on/off

[SOURce]	
[:MODulation]	
:IQ	
:ARB	ARB subsystem, page 4-105
:DIFFerential	Differential IQ outputs
:GAIN\?	
:ICHannel	
:BIAS\?	
:OFFSet\?	
:IQBias\?	
:LEVe\?	
:QCHAnnel	
:BIAS\?	
:OFFSet\?	
:DM	Digital modulation subsystem, page 4-113
:EANalog	External analog...
:IMPedance\?	...impedance
:BBGen	
[:STATE]\?	...baseband generator output
:EDIGital	External digital
:FILTer	
:EDGE	
[:BT]\?	
:GAUSSian	
[:BT]\?	
:NYQuist	
[:ALPHa]\?	
:RNYQuist	Root Nyquist
[:ALPHa]\?	
:STATe\?	
[:TYPE]\?	
:RMS	
[:VALue]	
:SRATe\?	Symbol rate
:SOURcel\?	
:STATe\?	

[SOURce][:MODulation]:IQ:DIFFerential:GAIN

Description: Sets the relative amplitudes of the I and Q signals.

Add gain (+ve dB) to decrease the magnitude of the Q component whilst leaving the I component unchanged. Remove gain (-ve dB) to decrease the magnitude of the I component whilst leaving the Q component unchanged.

Parameters: <numeric_value>

Valid values: <NRf> | MAXimum | MINimum

*RST sets: 0 dB

[SOURce][:MODulation]:IQ:DIFFerential:GAIN?

Description: Queries the gain value for relative amplitudes of the I and Q signals.

Parameters: None

Response: <NR2>

Returned values: dB

[SOURce][:MODulation]:IQ:DIFFerential:ICHannel:BIAS

Description: Sets the bias voltage of the I signal.

Parameters: <numeric_value>

Valid values: <NRf>Volts | MAXimum | MINimum

*RST sets: 0 V

[SOURce][:MODulation]:IQ:DIFFerential:ICHannel:BIAS?

Description: Queries the bias voltage of the I signal.

Parameters: None

Response: <NR2>

Returned values: Volts

[SOURce][:MODulation]:IQ:DIFFerential:ICHannel:OFFSet

Description: Sets the differential voltage between I and \bar{I} .

Parameters: <numeric_value>

Valid values: <NRf>Volts | MAXimum | MINimum

*RST sets: 0 V

[SOURce][:MODulation]:IQ:DIFFerential:ICHannel:OFFSet?

Description: Queries the differential voltage between I and \bar{I} .

Parameters: None

Response: <NR2>

Returned values: Volts

[SOURce][:MODulation]:IQ:DIFFerential:IQBias

Description: Sets the bias mode of the I and Q signals.

Parameters: <CPD>

Valid values: COUPled | INDEpendent

Coupled: I and Q bias voltages are varied simultaneously.

Independent: Allows independent setting of I and Q bias voltages.

*RST sets: COUPled

[SOURce][:MODulation]:IQ:DIFFerential:IQBias?

Description: Queries the bias mode of the I and Q signals.

Parameters: None

Response: <CRD>

Returned values: COUP | IND

[SOURce][:MODulation]:IQ:DIFFerential:LEVEL

Description: Sets the voltage level of the IQ signal.

Parameters: <numeric_value>

Valid values: <NRf> | MAXimum | MINimum

*RST sets: 2 V p-p

[SOURce][:MODulation]:IQ:DIFFerential:Level?

Description: Queries the voltage level of the IQ signal.

Parameters: None

Response: <NR2>

Returned values: V p-p

[SOURce][:MODulation]:IQ:DIFFerential:QCHannel:BIAS

Description: Sets the bias voltage of the Q signal.

Parameters: <numeric_value>

Valid values: <NRf> | MAXimum | MINimum

*RST sets: 0 V

[SOURce][:MODulation]:IQ:DIFFerential:QCHannel:BIAS?

Description: Queries the bias voltage of the Q signal.

Parameters: None

Response: <NR2>

Returned values: Volts

[SOURce][:MODulation]:IQ:DIFFerential:QCHannel:OFFSet

Description: Sets the differential voltage between Q and \bar{Q} .

Parameters: <numeric_value>

Valid values: <NRf> | MAXimum | MINimum

*RST sets: 0 V

[SOURce][:MODulation]:IQ:DIFFerential:QCHannel:OFFSet?

Description: Queries the differential voltage between Q and \bar{Q} .

Parameters: None

Response: <NR2>

Returned values: Volts

[SOURce][:MODulation]:IQ:EANalog:IMPedance

Description: Selects the impedance of the external analog source input — 50 Ω or 100 k Ω .

Parameters: <CPD>

Valid values: Z50 | K100

*RST sets: Z50 (in SCPI mode) or K100 (in 202x emulation).

[SOURce][:MODulation]:IQ:EANalog:IMPedance?

Description: Queries the impedance of the external source input — 50 Ω or 100 k Ω .

Parameters: None

Response: <CRD>

Returned values: Z50 | K100

[SOURCE][:MODulation]:IQ:EANalog:BBGen[:STATE]

Description: Turns the baseband generator on or off.

Parameters: <Boolean>

Valid values: OFF | ON | 0 | 1

*RST sets: OFF

[SOURCE][:MODulation]:IQ:EANalog:BBGen[:STATE]?

Description: Queries whether the baseband generator is on (1) or off (0).

Parameters: None

Response: <Boolean>

Returned values: 0 | 1

[SOURCE][:MODulation]:IQ:EDIGital:FILTer:GAUSSian[:BT]

Description: Sets the BT for the Gaussian filter.

Parameters: <numeric_value>

Valid values: <NRf> | MAXimum | MINimum

*RST sets: 0.3

[SOURCE][:MODulation]:IQ:EDIGital:FILTer:GAUSSian[:BT]?

Description: Returns the BT for the Gaussian filter.

Parameters: None

Response: <NR2>

Returned values: Bandwidth-time product

[SOURCE][:MODulation]:IQ:EDIGital:FILTer:NYQuist[:ALPHa]

Description: Sets the alpha for the Nyquist filter.

Parameters: <numeric_value>

Valid values: <NRf> | MAXimum | MINimum

*RST sets: 0.35

[SOURCE][:MODulation]:IQ:EDIGital:FILTer:NYQuist[:ALPHa]?

Description: Returns the alpha for the Nyquist filter.

Parameters: None

Response: <NR2>

Returned values: Alpha value

[SOURCE][:MODulation]:IQ:EDIGital:FILTer:RNYQuist[:ALPHa]

Description: Sets the alpha for the root Nyquist (raised cosine) filter.

Parameters: <numeric_value>

Valid values: <NRf> | MAXimum | MINimum

*RST sets: 0.35

[SOURCE][:MODulation]:IQ:EDIGital:FILTer:RNYQuist[:ALPHa]?

Description: Returns the alpha for the root Nyquist filter.

Parameters: None

Response: <NR2>

Returned values: Alpha value

[SOURCE][:MODulation]:IQ:EDIGital:FILTer[:TYPE]

Description: Sets the filter type.

Parameters: <CPD>

Valid values: EDGE | GAUSSian | NYQuist | RNYQuist

*RST sets: RNYQuist

[SOURCE][:MODulation]:IQ:EDIGital:FILTer[:TYPE]?

Description: Returns the filter type.

Parameters: None

Response: <CRD>

Returned values: EDGE | GAUS | NYQ | RNYQ

[SOURCE][:MODulation]:IQ:EDIGital:FILTer:STATe

Description: Turns the filter on or off.

Parameters: <Boolean>

Valid values: OFF | ON | 0 | 1

*RST sets: OFF

[SOURCE][:MODulation]:IQ:EDIGital:FILTer:STATe?

Description: Queries whether the filter is on or off.

Parameters: None

Response: <Boolean>

Returned values: 0 | 1

[SOURce][:MODulation]:IQ:EDIGital:RMS[:VALue]

Description: Sets the RMS value for the incoming signal.

Parameters: <numeric_value>

Valid values: <NRf> | MAXimum | MINimum

[SOURce][:MODulation]:IQ:EDIGital:RMS[:VALue]?

Description: Returns the RMS value set for the incoming signal.

Parameters: None

Response: <NR2>

[SOURce][:MODulation]:IQ:EDIGital:SRATE

Description: Sets the data rate.

Parameters: <numeric_value>

Valid values: <NRf> | MAXimum | MINimum

*RST sets: 100000.0

[SOURce][:MODulation]:IQ:EDIGital:SRATE?

Description: Returns the data rate.

Parameters: None

Response: <NR2>

Returned values: Data rate measured in Hz

[SOURce][:MODulation]:IQ:SOURce

Description: Sets the IQ modulation source.

Parameters: <CPD>

Valid values: ARB | DIFFerential | DM | EANalog | EDIGital

*RST sets: EANalog

[SOURce][:MODulation]:IQ:SOURce?

Description: Returns the IQ modulation source.

Parameters: None

Response: <CRD>

Returned values: ARB | DIFF | DM | EAN | EDIG

[SOURce][:MODulation]:IQ:STATe

Description: Turns the IQ path on or off.

Parameters: <Boolean>

Valid values: OFF | ON | 0 | 1

*RST sets: OFF

[SOURce][:MODulation]:IQ:STATe?

Description: Queries whether the IQ path is on (1) or off (0).

Parameters: None

Response: <Boolean>

Returned values: 0 | 1

IQ commands — ARB subsystem

([SOURce][:MODulation]:IQ:ARB subsystem)

ARB waveform generation, handling and parameter set-up

Commands for:

- Controlling ARB generation
- Formatting ARB memory
- File handling

[SOURce]

[:MODulation]

:IQ

:ARB

:ABORt

:INITiate

:MEMORy

:FORMat\?

:MODE\?

:MULTiple

:REPEat?

:REStart?

:RMSoffset\?

:TOFFset\?

:TRIGger\?

:HOLDoff\?

:WAVEform

:BURSt

:PRESet

:CATalog?

:CHECKsum?

:DELeTe

:ALL

[:FILE]

:DLOad

:HEADer?

:SELeCt\?

:SUMMARy?

ARB tuning offset

[SOURce][:MODulation]:IQ:ARB:ABORT

Description: Stops ARB generation.

Parameters: None

[SOURce][:MODulation]:IQ:ARB:INITiate

Description: Starts ARB generation.

Parameters: None

[SOURce][:MODulation]:IQ:ARB:MEMory:FORMat

Description: Formats the ARB memory with the requested number of wide sectors, reserved as narrow sectors. Each reserved wide sector will give three narrow ones.

Parameters: <numeric_value>

Valid values: <NRf> | MAXimum | MINimum

[SOURce][:MODulation]:IQ:ARB:MEMory:FORMat?

Description: Returns the ARB memory's formatting information.

Parameters: None

Response: <NR1>,<NR1>,<NR1>

Returned values: Memory size in wide sectors, number of formatted narrow sectors, number of formatted wide sectors.

[SOURce][:MODulation]:IQ:ARB:MODE

Description: Controls ARB generation. CONTinuous generates the selected waveform continuously. A SINGle command generates one cycle of the selected waveform. MULTiple outputs a set number of cycles.

Parameters: <CPD>

Valid values: SINGle | CONTinuous | MULTiple

*RST sets: CONT

[SOURce][:MODulation]:IQ:ARB:MODE?

Description: Returns the ARB generation mode.

Parameters: None

Response: <CRD>

Returned values: SING | CONT | MULT

[SOURce][:MODulation]:IQ:ARB:MULTiple:REPeat

Description: Only used when IQ:ARB:MODE is set to MULTiple. Defines the number of repeats of the waveform. The waveform outputs once, then repeats for the number of times defined.

Parameters: <NRf>

Valid values: 000 to 255

*RST sets: 000

[SOURce][:MODulation]:IQ:ARB:MULTiple:REPeat?

Description: Returns the number of repeats requested.

Parameters: None

Response: <NR1>

Returned values: Number of repeats

[SOURce][:MODulation]:IQ:ARB:REStart

Description: Defines whether a waveform already playing can be restarted by the trigger input.

Parameters: <CPD>

Valid values: ENABLE | DISable

*RST sets: DIS

[SOURce][:MODulation]:IQ:ARB:REStart?

Description: Returns whether a waveform already playing can be restarted by the trigger input.

Parameters: <CPD>

Response: <CRD>

Returned values: ENAB | DIS

[SOURce][:MODulation]:IQ:ARB:RMSoffset

Description: Adjusts the RMS offset level of the ARB waveform.

Parameters: <numeric_value>

Valid values: <NRf> | MAXimum | MINimum

*RST sets: 0 dB

[SOURce][:MODulation]:IQ:ARB:RMSoffset?

Description: Returns the modulation level's RMS offset.

Parameters: None

Response: <NR2>

Returned values: Modulation RMS offset value in dB

[SOURce][:MODulation]:IQ:ARB:TOFFset

Description: Adjusts the sample clock's tuning offset in parts per million.

Parameters: <numeric_value>

Valid values: <NRf> | MAXimum | MINimum

*RST sets: 0

[SOURce][:MODulation]:IQ:ARB:TOFFset?

Description: Returns the sample clock's tuning offset.

Parameters: None

Response: <NR2>

Returned values: Tuning offset in parts per million

[SOURce][:MODulation]:IQ:ARB:TRIGger

Description: Sets the trigger mode to immediate; start; start then stop; gated.

Parameters: <CPD>

Valid values: IMMEDIATE | START | SSTOP | GATED

*RST sets: IMM

[SOURce][:MODulation]:IQ:ARB:TRIGger?

Description: Returns the trigger mode.

Parameters: None

Response: <CRD>

Returned values: IMM | STAR | SSTOP | GAT

[SOURce][:MODulation]:IQ:ARB:TRIGger:HOLDoff

Description: Sets a delay before the ARB starts to run, following a trigger event.

Parameters: <NRf>

Valid values: s, ms, μ s, up to 60 s

*RST sets: 0 s

[SOURce][:MODulation]:IQ:ARB:TRIGger:HOLDoff?

Description: Returns the trigger holdoff time.

Parameters: None

Response: <NR2>

Returned values: Holdoff time

[SOURce][:MODulation]:IQ:ARB:WAVEform:BURSt:PRESet

Description: Sets the burst parameters to the default values for the currently selected waveform. If no waveform is selected, the instrument defaults are loaded.

Parameters: None

[SOURCE]:MODulation:IQ:ARB:WAVeform:CATalog?

Description: Returns memory available and a list of files.

Parameters: None

Response: <numeric_value>,<numeric_value>,<numeric_value>{,<string>}
<Free narrow sectors>,<Free wide sectors>,<Memory available>,{File list}

The string for each file is <name> (in character data)

Returned values: Free narrow sectors: the number of sectors (and therefore the number of low sample-rate files) that can be stored.

Free wide sectors: the space left for larger high sample-rate files.

Memory available: number of samples that can be stored in the largest contiguous block.

File list: list of filenames, separated by commas.

Example: :IQ:ARB:WAV:CAT? 5111808,"is95_1.aiq","is95_2.aiq"

[SOURCE]:MODulation:IQ:ARB:WAVeform:CHECKsum?

Description: Returns information on whether the checksum on the file has verified.

Parameters: <string response data>
<name>

Response: <NR1>

Returned values: 1 checksum has verified correctly
0 checksum failure.

Example: :IQ:ARB:WAV:CHEC? "is95.aiq" 1

[SOURCE]:MODulation:IQ:ARB:WAVeform:DELEte:ALL

Description: Deletes all the user files in the ARB, without removing calibration files.

Parameters: None

[SOURCE]:MODulation:IQ:ARB:WAVeform:DELEte[FILE]

Description: Deletes the named file.

Parameters: <string program data>

Valid values: ARB filename

Example: :IQ:ARB:WAV:DEL "is95.aiq"

[SOURce][:MODulation]:IQ:ARB:WAVeform:DLOad

Description: Copies data in block format to the ARB memory, with name.

Parameters: <string program data>,<arbitrary block program data>
<name>,<data>

Valid values: ARB filename, 256 characters max; block of packaged data

Example: :IQ:ARB:WAV:DL "is95.aiq",#3848<848 8-bit blocks of data>

See page 4-7 for an explanation of the structure of the command parameters.

*Note: Large amounts of ARB data may need to be sent in blocks.
For example, using a National Instruments GPIB board:*

SendSetup sets the 341x to receive data

SendDataBytes with Nullend sends data in blocks

Final block: SendDataBytes with Nlend asserts EOI.

[SOURce][:MODulation]:IQ:ARB:WAVeform:HEADer?

Description: Returns the file header in ASCII format, with lines separated by carriage return/line feed. Can consist of up to 1000 characters.

Parameters: <string response data>
<name>

Response: <arbitrary block response data>

Returned values: File header text

Example: :IQ:ARB:WAV:HEAD? "is95.aiq" <file header text>

[SOURce][:MODulation]:IQ:ARB:WAVeform:SELEct

Description: Selects the named file to generate the waveform and starts ARB generation in single or continuous mode, according to the MODE selected.

Parameters: <string program data>

Valid values:
ARB filename

Example: :IQ:ARB:WAV:SEL "is95.aiq"

[SOURce][:MODulation]:IQ:ARB:WAVeform:SELEct?

Description: Returns the name of the selected ARB file.

Parameters: None

Response: <string response data>

Returned values: ARB filename

Example: :IQ:ARB:WAV:SEL? "is95.aiq"

[SOURce][:MODulation]:IQ:ARB:WAVeform:SUMMary?

Description: Returns the number of samples and the IQ sample rate of the selected ARB file.

Parameters: <string response data>
<name>

Response: <NR1>,<NR1>

Returned values: Number of samples, sample rate.

Example: :IQ:ARB:WAV:SUMM? "is95.aiq" 12800,12400000

IQ commands — DM subsystem

([SOURce][:MODulation]:IQ:DM subsystem)

Digital waveform generation, file handling and clock set-up

Commands for:

- Configuring the clock source
- Handling user configuration and data pattern files
- Setting modulation format

```
[SOURce]
  [:MODulation]
    :IQ
      :DM
        :CLOCK
          :EXternal
            :SYNChronize
          :SOURce\?
        :CONFIguration
          :CATalog?
          :CHECKsum?
          :DELeTe
            :ALL
            [:FILE]
          :DLOad
          :SELeT\?
          :SUMMery?
        :FORMat\?
        :GENeric
        :TONes
        :USER
          :DATA
            :CATalog?
            :CHECKsum?
            :DELeTe
              :ALL
              [:FILE]
            :DLOad
```

Generic subsystem, page 4-123

Tones subsystem, page 4-119

[SOURCE][:MODulation]:IQ:DM:CLOCK:EXTERNAL:SYNChronise

Description: Synchronizes the internal and external clocks.

Parameters: None

Valid values: None

[SOURCE][:MODulation]:IQ:DM:CLOCK:SOURce

Description: Sets the clock source.

Parameters: <CPD>

Valid values: EXTERNAL | INTERNAL

*RST sets: INTERNAL

[SOURCE][:MODulation]:IQ:DM:CLOCK:SOURce?

Description: Returns the clock source.

Parameters: None

Response: <CRD>

Returned values: EXT | INT

[SOURCE][:MODulation]:IQ:DM:CONFiguration:CATalog?

Description: Returns number of files and a list of all configuration files.

Parameters: None

Response: <numeric_value>,<numeric_value>,{<string>}

<Number of files>,<Free space>,{File list}

The string for each file is <name> (in character data).

Returned values: Number of files in the catalog.

Free space available, in bytes.

File list: list of filenames, separated by commas.

[SOURCE][:MODulation]:IQ:DM:CONFIguration:CHECKsum?

Description: Returns information on whether the checksum on the file has verified.

Parameters: <string program data>
<name>

Response: <NR1>

Returned values: 1 checksum has verified correctly
0 checksum failure.

[SOURCE][:MODulation]:IQ:DM:CONFIguration:DELeTe:ALL

Description: Deletes all the user configuration files.

Parameters: None

[SOURCE][:MODulation]:IQ:DM:CONFIguration:DELeTe:FILE

Description: Deletes the named user configuration file.

Parameters: <string program data>

Valid values: User filename

[SOURCE][:MODulation]:IQ:DM:CONFIguration:DLOad

Description: Downloads the named user configuration file.

Parameters: <string program data>,<arbitrary block program data>
<name>,<data>

Valid values: User filename (40 characters max.), the data

[SOURCE][:MODulation]:IQ:DM:CONFIguration:SELeCt

Description: Selects the named user configuration file.

Parameters: <string program data>

Valid values: ARB filename

[SOURCE][:MODulation]:IQ:DM:CONFIguration:SELeCt?

Description: Returns the name of the selected user configuration file.

Parameters: None

Response: <string response data>

Returned values: User configuration filename

[SOURce][:MODulation]:IQ:DM:CONFIguration:SUMMary?

Description: Returns a summary of the selected user configuration file.

Parameters: <string response data>
<name>

Response: <CRD>

Returned values: Format, modulation, symbol rate, filter, bandwidth

[SOURce][:MODulation]:IQ:DM:FORMat

Description: Sets the digital modulation format.

Parameters: <CPD>

Valid values: GENeric | TONes

*RST sets: GENeric

[SOURce][:MODulation]:IQ:DM:FORMat?

Description: Returns the selected digital modulation format.

Parameters: None

Response: <CRD>

Returned values: GEN | TON

[SOURce][:MODulation]:IQ:DM:USER:DATA:CATalog?

Description: Returns memory available and a list of data pattern files.

Parameters: None

Response: <numeric_value>,<numeric_value>{,<string>}

<Number of files>,<Free space>,{File list}

The string for each file is <name> (in character data).

Returned values: Number of files in the catalog.

Free space in bytes.

File list: list of filenames, separated by commas.

[SOURCE][:MODulation]:IQ:DM:USER:DATA:CHECKsum?

Description: Returns information on whether the checksum on the files has verified.

Parameters: <string response data>
<name>

Response: <NR1>

Returned values: 1 checksum has verified correctly
0 checksum failure

[SOURCE][:MODulation]:IQ:DM:USER:DATA:DELEte:ALL

Description: Deletes all the user data pattern files.

Parameters: None

[SOURCE][:MODulation]:IQ:DM:USER:DATA:DELEte[:FILE]

Description: Deletes the named user data pattern file.

Parameters: <string program data>

Valid values: User filename

[SOURCE][:MODulation]:IQ:DM:USER:DATA:DLOad

Description: Downloads the named user data pattern file.

Parameters: <string program data>,<NRf>,<arbitrary block program data>

Valid values: User filename, 40 characters max.

IQ commands — DM:Tones subsystem

([SOURce][:MODulation]:IQ:DM:TONE subsystem)

Tones set-up

Commands for setting tone frequency, level and state.

```
[SOURce]
  [:MODulation]
    :IQ
      :DM
        :TONes
          :A
            :FREQuency?
            :STATe?
          :B
            :FREQuency?
            :LEVeL?
            :STATe?
```

[SOURce][:MODulation]:IQ:DM:TONes:A:FREQuency

Description: Sets the frequency of Tone A.

Parameters: <numeric_value>

Valid values: <Nrf>(Hz) | MAXimum | MINimum

*RST sets: 5000.0

[SOURce][:MODulation]:IQ:DM:TONes:A:FREQuency?

Description: Returns the frequency of Tone A.

Parameters: None

Response: <NR2>

Returned values: Hz

[SOURce][:MODulation]:IQ:DM:TONes:A:STATe

Description: Turns Tone A on and off.

Parameters: <Boolean>

Valid values: OFF | ON | 0 | 1

*RST sets: OFF

[SOURce][:MODulation]:IQ:DM:TONes:A:STATe?

Description: Returns whether Tone A is on or off.

Parameters: None

Response: <Boolean>

Returned values: 0 | 1

[SOURCE][:MODulation]:IQ:DM:TONes:B:FREQuency

Description: Sets the frequency of Tone B.

Parameters: <numeric_value>

Valid values: <NRf>(Hz) | MAXimum | MINimum

*RST sets: 10000.0

[SOURCE][:MODulation]:IQ:DM:TONes:B:FREQuency?

Description: Returns the frequency of Tone B.

Parameters: None

Response: <NR2>

Returned values: Hz

[SOURCE][:MODulation]:IQ:DM:TONes:B:LEVel

Description: Sets the level of Tone B relative to Tone A.

Parameters: <numeric_value>

Valid values: <NRf>(dB) | MAXimum | MINimum

*RST sets: 0.0

[SOURCE][:MODulation]:IQ:DM:TONes:B:LEVel?

Description: Returns the level of Tone B relative to Tone A.

Parameters: None

Response: <NR2>

Returned values: dB

[SOURce][:MODulation]:IQ:DM:TONes:B:STATE

Description: Turns Tone B on and off.

Parameters: <Boolean>

Valid values: OFF | ON | 0 | 1

*RST sets: OFF

[SOURce][:MODulation]:IQ:DM:TONes:B:STATE?

Description: Returns whether Tone B is on or off.

Parameters: None

Response: <Boolean>

Returned values: 0 | 1

IQ commands — DM:Generic subsystem

([SOURce][:MODulation]:IQ:DM:Generic subsystem)

Generic modulation set-up

Commands for:

- Setting data encoding
- Setting data source
- Setting filter characteristics
- Setting modulation type
- Setting FSK2 deviation
- Setting symbol rate
- Handling markers: on/off, transition points, repeat lengths

```
[SOURce]
  [:MODulation]
    :IQ
      :DM
        :GENeric
          :DATA
            : ENCoding\?
            [:SOURce]\?
            :USER
            [:FILename]\?
          :FILTer
            :GAUSSian
            [:BT]\?
            :NYQuist
            [:ALPHa]\?
            :RNYQuist
            [:ALPHa]\?
            [:TYPE]\?
          :MARKer<1to3>
          :TRANSition
            :CLEar
            [:TEND]
            :LIST\?
            :REPeat\?
          :MODulation
            :FSK2
            :DEViation\?
            :FSK4
            :DEViation\?
            [:TYPE]\?
          :SRATE\?
          :STATE\?
```

[SOURCE]:MODulation:IQ:DM:GENERIC:DATA:ENCoding

Description: Sets the type of data encoding.

Parameters: <CPD>

Valid values: OFF | INVerted | DIFFerential | GDIFerential

*RST sets: OFF

[SOURCE]:MODulation:IQ:DM:GENERIC:DATA:ENCoding?

Description: Returns the type of data encoding.

Parameters: None

Response: <CRD>

Returned values: OFF | INV | DIFF | GDIF

[SOURCE]:MODulation:IQ:DM:GENERIC:DATA[:SOURCE]

Description: Sets the generated data to be a predefined format, or external input, or as defined in the file defined by the :USER command.

Parameters: <CPD>

Valid values: PN9 | PN11 | PN15 | PN16 | PN20 | PN21 | PN23 | ONES | ZERos
| A01Pattern | A10Pattern | ESERial | EPARallel | USER

*RST sets: PN9

[SOURCE]:MODulation:IQ:DM:GENERIC:DATA[:SOURCE]?

Description: Returns the source used for the generated file.

Parameters: None

Response: <CRD>

Returned values: PN9 | PN11 | PN15 | PN16 | PN20 | PN21 | PN23 | ONES | ZER | ALT01 | ALT10 |
ESER | EPAR | USER

[SOURCE][:MODulation]:IQ:DM:GENeric:DATA:USER[:FILEname]

Description: Specifies the file containing the data format.

Parameters: <string program data>

Valid values: <filename>

[SOURCE][:MODulation]:IQ:DM:GENeric:DATA:USER[:FILEname]?

Description: Returns the file that contains the data format.

Parameters: None

Response: <string response data>

Returned values: <filename>

[SOURCE][:MODulation]:IQ:DM:GENeric:FILTer:GAUSSian[:BT]

Description: Sets the BT for the Gaussian filter.

Parameters: <numeric_value>

Valid values: <NRf> | MAXimum | MINimum

*RST sets: 0.3

[SOURCE][:MODulation]:IQ:DM:GENeric:FILTer:GAUSSian[:BT]?

Description: Returns the BT for the Gaussian filter.

Parameters: None

Response: <NR2>

Returned values: Bandwidth-time product

[SOURCE][:MODulation]:IQ:DM:GENERIC:FILTER:NYQUIST[:ALPHA]

Description: Sets the alpha for the Nyquist filter.

Parameters: <numeric_value>

Valid values: <NRf> | MAXimum | MINimum

*RST sets: 0.35

[SOURCE][:MODulation]:IQ:DM:GENERIC:FILTER:NYQUIST[:ALPHA]?

Description: Returns the alpha for the Nyquist filter.

Parameters: None

Response: <NR2>

Returned values: Alpha value

[SOURCE][:MODulation]:IQ:DM:GENERIC:FILTER:RNYQUIST[:ALPHA]

Description: Sets the alpha for the root Nyquist (raised cosine) filter.

Parameters: <numeric_value>

Valid values: <NRf> | MAXimum | MINimum

*RST sets: 0.35

[SOURCE][:MODulation]:IQ:DM:GENERIC:FILTER:RNYQUIST[:ALPHA]?

Description: Returns the alpha for the root Nyquist filter.

Parameters: None

Response: <NR2>

Returned values: Alpha value

[SOURCE][:MODulation]:IQ:DM:GENeric:FILTer[:TYPE]

Description: Sets the filter type.

Parameters: <CPD>

Valid values: EDGE | GAUSSian | NYQuist | RNYQuist

*RST sets: RNYQuist

[SOURCE][:MODulation]:IQ:DM:GENeric:FILTer[:TYPE]?

Description: Returns the filter type.

Parameters: None

Response: <CRD>

Returned values: EDGE | GAUS | NYQ | RNYQ

[SOURCE][:MODulation]:IQ:DM:GENeric:MARKer<1to3>:STATe

Description: Turns the selected marker on or off.

Parameters: <Boolean>

Valid values: OFF | ON | 0 | 1

*RST sets: OFF

[SOURCE][:MODulation]:IQ:DM:GENeric:MARKer<1to3>:STATe?

Description: Queries whether the selected marker is on or off.

Parameters: None

Response: <Boolean>

Returned values: 0 | 1

**[SOURCE][:MODulation]:IQ:DM:GENeric:MARKer<1to3>:TRANSition
CLEar[:TEND]**

Description: Clears the general purpose marker transition points from this point up to the end of the list. If no value is entered, 0 is assumed, which clears all.

Parameters: <numeric_value>

Valid values: NRf

**[SOURce][:MODulation]:IQ:DM:GENeric:MARKer<1to3>:TRANSition
:LIST**

Description: Transition points are measured in symbols (the 'offset') from the preceding point. The status of the burst marker changes at each transition point, starting at LOW level. Setting any offset except the first to 0 causes remaining arguments to be set to 0 and ignored. Setting the first transition point to 0 causes a transition to HIGH level on the first symbol. See Fig. 4-2 on page 4-68 for an example.

Parameters: <NRf>,<NRf>[<NRf>...]

Valid values: StartTransitionPoint,tp1[,tp2....tp16]

*RST sets: All 0s

Example: :IQ:DM:GEN:MARK3:TRAN:LIST 1,5,5,990,10,10,5,975,2,0

**[SOURce][:MODulation]:IQ:DM:GENeric:MARKer<1to3>:TRANSition
:LIST?**

Description: Queries the generic modulation marker transition points.

Parameters: None

Response: <NR1>,<NR1>[,<NR1...<NR1>]

Returned values: Offsets in symbols

Example: :IQ:DM:GEN:MARK3:TRAN:LIST?
1,5,5,990,10,10,5,975,2,0

[SOURce][:MODulation]:IQ:DM:GENeric:MARKer<1to3>:TRANsition :REPeat

Description: Sets the repeat length of the general purpose marker. See Fig. 4-3 on page 4-69 for an example.

Parameters: <numeric_value>

Valid values: <NRf>(transitions) | MAXimum | MINimum

*RST sets: 0

Example: :IQ:DM:GEN:MARK3:TRAN:REP 4

[SOURce][:MODulation]:IQ:DM:GENeric:MARKer<1to3>:TRANsition :REPeat?

Description: Queries the repeat length of the burst marker.

Parameters: None

Response: <NR1>

Returned values: Repeat length in transitions

Example: :IQ:DM:GEN:MARK3:TRAN:REP? 4

[SOURce][:MODulation]:IQ:DM:GENeric:MODulation[:TYPE]

Description: Sets the modulation type.

Parameters: <CPD>

Valid values: FSK2 | FSK4 | MSK | BPSK | QPSK | PSK8 | PSK16 | EPSK8 |
PI2Dbpsk | PI4Dqpsk | PI8Dpsk8 | DBPSk | DQPSk | DPSK8 | OQPSk |
QAM16 | QAM32 | QAM64 | QAM128 | QAM256

*RST sets: PSK8

[SOURce][:MODulation]:IQ:DM:GENeric:MODulation[:TYPE]?

Description: Queries the modulation type.

Parameters: None

Response: <CRD>

Returned values: FSK2 | FSK4 | MSK | BPSK | QPSK | PSK8 | PSK16 | EPSK8 |
PI2D | PI4D | PI8D | DBPS | DQPS | DPSK8 | OQPS |
QAM16 | QAM32 | QAM64 | QAM128 | QAM256

[SOURce][:MODulation]:IQ:DM:GENeric:MODulation:FSK2:DEViation

Description: Sets the deviation for FSK2 modulation.

Parameters: <numeric_value>

Valid values: <NRf> | MAXimum | MINimum

*RST sets: 600.0 Hz

[SOURce][:MODulation]:IQ:DM:GENeric:MODulation:FSK2:DEViation?

Description: Returns the deviation set for FSK2 modulation.

Parameters: None

Response: <NR2>

Returned values: Hz

[SOURce][:MODulation]:IQ:DM:GENeric:MODulation:FSK4:DEViation

Description: Sets the modulation deviation for FSK4 modulation.

Parameters: <numeric_value>

Valid values: <NRf> | MAXimum | MINimum

*RST sets: 600.0 Hz

[SOURce][:MODulation]:IQ:DM:GENeric:MODulation:FSK4:DEViation?

Description: Returns the modulation deviation set for FSK4 modulation.

Parameters: None

Response: <NR2>

Returned values: Hz

[SOURCE][:MODulation]:IQ:DM:GENeric:SRATe

Description: Sets the symbol rate.

Parameters: <numeric_value>

Valid values: <NRf> | MAXimum | MINimum

*RST sets: 100000.0

[SOURCE][:MODulation]:IQ:DM:GENeric:SRATe?

Description: Returns the symbol rate.

Parameters: None

Response: <NR2>

Returned values:

Phase modulation commands

([SOURce][:MODulation]:PM subsystem)

Phase modulation deviation, source, frequency, waveshape, mod. sweep, phase, input parameters

Commands for:

- Setting phase modulation frequency and frequency step size
- Setting phase modulation deviation and deviation step size
- Setting phase modulation impedance and sensitivity
- Setting phase modulation mode (fixed or sweep)
- Setting phase modulation waveshape and time per sweep
- Setting phase modulation sweep parameters
- Setting internal/external source on/off
- Setting phase relationship of PM2 with respect to PM1.

```
[SOURce]
  [:MODulation]
    :PM[1]|2
      [:DEViation]?
        :STEP
          [:INCRement]\?
      :EXTernal
        :IMPedance\?
        :SENSitivity\?
      :INTernal
        :FREQUency\?
          [:FIXed]
            :STEP
              [:INCRement]\?
        :MODE\?
        :SWEep
          :DWELI\?
          :MANual
          :SPACing\?
          :START\?
          :STEP
            [:LINear]\?
            :LOGarithmic\?
          :STOP\?
        :SHAPE\?
      :SOURce\?
      :STATe\?
:PM2
  :INTernal
    :PHASe\?
    :SENSitivity\?
```

[SOURce][:MODulation]:PM[1]|2[:DEViation]

Description: Sets the phase modulation deviation.

Parameters: <numeric_value>

Valid values: <NRf>(rad) | MAXimum | MINimum | UP | DOWN | RETurn | REFerence

Set by value, to maximum or minimum, stepping up or down, returning to the last full setting, or setting the current value to the last full setting.

*RST sets: MIN

[SOURce][:MODulation]:PM[1]|2[:DEViation]?

Description: Queries the phase modulation deviation.

Parameters: None

Response: <NR2>

Returned values: Phase modulation deviation in radians

[SOURce][:MODulation]:PM[1]|2[:DEViation]:STEP[:INCRement]

Description: Sets the phase modulation deviation step size.

Parameters: <numeric_value>

Valid values: <NRf>(rad) | MAXimum | MINimum

*RST sets: 0.1 rad

[SOURce][:MODulation]:PM[1]|2[:DEViation]:STEP[:INCRement]?

Description: Queries the phase modulation deviation step size.

Parameters: None

Response: <NR2>

Returned values: Phase modulation step size in radians

[SOURCE][:MODulation]:PM[1]|2:EXTernal:IMPedance

Description: Selects the impedance of the external source input — 50 Ω or 100 k Ω .

Parameters: <CPD>

Valid values: Z50 | K100

*RST sets: Z50 (in SCPI mode) or K100 (in 202x emulation).

[SOURCE][:MODulation]:PM[1]|2:EXTernal:IMPedance?

Description: Queries the impedance of the external source input — 50 Ω or 100 k Ω .

Parameters: None

Response: <CRD>

Returned values: Z50 | K100

[SOURCE][:MODulation]:PM[1]|2:EXTernal:SENSitivity

Description: Selects the sensitivity of the external source input for phase modulation — 1 V RMS or 1 V peak

Parameters: <CPD>

Valid values: VRMS | VPK

*RST sets: VRMS

[SOURCE][:MODulation]:PM[1]|2:EXTernal:SENSitivity?

Description: Queries the sensitivity of the external source input for phase modulation.

Parameters: None

Response: <CRD>

Returned values: VRMS | VPK

[SOURce][:MODulation]:PM[1]|2:INTernal:FREQUency[:FIXed]

Description: Sets the internal phase modulation frequency.

Parameters: <numeric_value>

Valid values: <NRf>(Hz) | MAXimum | MINimum | UP | DOWN | RETurn | REFerence

Set by value, to maximum or minimum, stepping up or down, returning to the last full setting, or setting the current value to the last full setting.

*RST sets: PM1 = 1 kHz, PM2 = 400 Hz

[SOURce][:MODulation]:PM[1]|2:INTernal:FREQUency[:FIXed]?

Description: Queries the internal phase modulation frequency.

Parameters: None

Response: <NR2>

Returned values: Phase modulation frequency in Hz

[SOURce][:MODulation]:PM[1]|2:INTernal:FREQUency[:FIXed]:STEP[:INCRement]

Description: Set the internal phase modulation frequency step.

Parameters: <numeric_value>

Valid values: <NRf>(Hz) | MAXimum | MINimum

*RST sets: 10 Hz

[SOURce][:MODulation]:PM[1]|2:INTernal:FREQUency[:FIXed]:STEP[:INCRement]?

Description: Queries the internal phase modulation frequency step size.

Parameters: None

Response: <NR2>

Returned values: Phase modulation frequency step size in Hz

[SOURce][:MODulation]:PM[1]|2:INTernal:FREQuency:MODE

Description: Sets the mode of the phase modulation frequency operation.

Parameters: <CPD>

Valid values: FIXed | SWEEp

*RST sets: FIXed

[SOURce][:MODulation]:PM[1]|2:INTernal:FREQuency:MODE?

Description: Queries the mode of the phase modulation frequency operation (fixed or sweep).

Parameters: None

Response: <CRD>

Returned values: FIX | SWE

**[SOURce][:MODulation]:PM[1]|2:INTernal:FREQuency:SWEEp
:DWELI**

Description: Sets the time per sweep step for phase modulation.

Parameters: <numeric_value>

Valid values: <NRf>(ms) | MAXimum | MINimum

*RST sets: 50 ms

**[SOURce][:MODulation]:PM[1]|2:INTernal:FREQuency:SWEEp
:DWELI?**

Description: Queries the time per sweep step for phase modulation.

Parameters: None

Response: <NR2>

Returned values: Dwell time in ms

[SOURce][:MODulation]:PM[1]|2:INTernal:FREQuency:SWEep :MANual

Description: Sets a new phase modulation frequency whilst a sweep is paused.

Parameters: <numeric_value>

Valid values: <Nrf>(Hz) | MAXimum | MINimum | UP | DOWN

Set by value, to maximum or minimum, or stepping up or down.

This command is available only when PM[1]|2:INTernal:MODE SWEep is selected, and sweep operation is not in progress (PAUSED or WAITING FOR TRIGGER). The frequency value should be limited to the range determined by PM[1]|2:INTernal:SWEep:START and PM[1]|2:INTernal:SWEep:STOP.

[SOURce][:MODulation]:PM[1]|2:INTernal:FREQuency:SWEep :MANual?

Description: Queries the phase modulation frequency set during a paused sweep.

Parameters: None

Response: <NR2>

Returned values: Phase modulation frequency in Hz

[SOURce][:MODulation]:PM[1]|2:INTernal:FREQuency:SWEep :SPACing

Description: Sets the mode of sweep spacing for phase modulation.

Parameters: <CPD>

Valid values: LINear | LOGarithmic

*RST sets: LIN

[SOURce][:MODulation]:PM[1]|2:INTernal:FREQuency:SWEep :SPACing?

Description: Queries the mode of sweep spacing for phase modulation.

Parameters: None

Response: <CRD>

Returned values: LIN | LOG

**[SOURce][:MODulation]:PM[1]|2:INTernal:FREQuency:SWEep
:STARt**

Description: Sets the start frequency for the phase modulation sweep.

Parameters: <numeric_value>

Valid values: <NRf>(Hz) | MAXimum | MINimum

*RST sets: MIN

**[SOURce][:MODulation]:PM[1]|2:INTernal:FREQuency:SWEep
:STARt?**

Description: Queries the start frequency for the phase modulation sweep.

Parameters: None

Response: <NR2>

Returned values: Phase modulation start frequency in Hz

**[SOURce][:MODulation]:PM[1]|2:INTernal:FREQuency:SWEep
:STEP[:LINear]**

Description: Sets the size of the step for linear phase modulation sweeps.

Parameters: <numeric_value>

Valid values: <NRf>(Hz) | MAXimum | MINimum

*RST sets: 1 kHz

**[SOURce][:MODulation]:PM[1]|2:INTernal:FREQuency:SWEep
:STEP[:LINear]?**

Description: Queries the size of the step for linear phase modulation sweeps.

Parameters: None

Response: <NR2>

Returned values: Linear sweep step size in Hz

**[SOURce][:MODulation]:PM[1]|2:INTernal:FREQuency:SWEep
:STEP:LOGarithmic**

Description: Sets the size of the step for logarithmic phase modulation sweeps as a percentage.

Parameters: <numeric_value>

Valid values: <NRf>(PCT) | MAXimum | MINimum

*RST sets: 1 PCT

**[SOURce][:MODulation]:PM[1]|2:INTernal:FREQuency:SWEep
:STEP:LOGarithmic?**

Description: Queries the size of the step for logarithmic phase modulation sweeps.

Parameters: None

Response: <NR2>

Returned values: Logarithmic sweep step size as a percentage

**[SOURce][:MODulation]:PM[1]|2:INTernal:FREQuency:SWEep
:STOP**

Description: Sets the stop frequency for the phase modulation sweep.

Parameters: <numeric_value>

Valid values: <NRf>(Hz) | MAXimum | MINimum

*RST sets: MAX

**[SOURce][:MODulation]:PM[1]|2:INTernal:FREQuency:SWEep
:STOP?**

Description: Queries the stop frequency for the phase modulation sweep.

Parameters: None

Response: <NR2>

Returned values: Phase modulation sweep stop frequency in Hz

[SOURce][:MODulation]:PM[1]|2:INTernal:SHAPE

Description: Selects the shape of the internally generated phase modulation.

Parameters: <CPD>

Valid values: SINE | SQUare | TRIangle | RAMP

*RST sets: SINE

[SOURce][:MODulation]:PM[1]|2:INTernal:SHAPE?

Description: Queries the shape of the internally generated phase modulation.

Parameters: None

Response: <CRD>

Returned values: SINE | SQU | TRI | RAMP

[SOURce][:MODulation]:PM[1]|2:SOURce

Description: Selects either an internal or external source to generate phase modulation.

Parameters: <CPD>

Valid values: INTernal | EXTernal

*RST sets: INT

[SOURce][:MODulation]:PM[1]|2:SOURce?

Description: Queries whether the source for phase modulation is internal or external.

Parameters: None

Response: <CRD>

Returned values: INT | EXT

[SOURce][:MODulation]:PM[1]|2:STATe

Description: Adds PM1 or PM2 to the set of active modulations, or removes PM1 or PM2 from it: see Fig. 4-1 on page 4-19.

Parameters: <Boolean>

Valid values: OFF | ON | 0 | 1

*RST sets: OFF

[SOURce][:MODulation]:PM[1]|2:STATe?

Description: Queries whether the phase modulation path is on (1) or off (0).

Parameters: None

Response: <Boolean>

Returned values: 0 | 1

[SOURce][:MODulation]:PM2:INTernal:PHASe

Description: Sets the phase offset of PM2 relative to PM1.

Parameters: <numeric_value>

Valid values: <NRf> | UP | DOWN

*RST sets: 0

[SOURce][:MODulation]:PM2:INTernal:PHASe?

Description: Queries the phase offset of PM2 relative to PM1.

Parameters: None

Response: <NR2>

Returned values: Phase angle (degrees)

[SOURce][:MODulation]:PM2:INTernal:PHASe:SENSitivity

Description: Selects the sensitivity of the rotary control or $\left(\begin{smallmatrix} \times 10 \\ \downarrow \end{smallmatrix}\right)$ and $\left(\begin{smallmatrix} +10 \\ \uparrow \end{smallmatrix}\right)$ keys when setting up the phase offset of PM2 relative to PM1.

Parameters: <CPD>

Valid values: FINE (0.01° resolution)
MEDIum (0.1° resolution)
COARse (1.0° resolution)

*RST sets: FINE

[SOURce][:MODulation]:PM2:INTernal:PHASe:SENSitivity?

Description: Queries the sensitivity of the rotary control or $\left(\begin{smallmatrix} \times 10 \\ \downarrow \end{smallmatrix}\right)$ and $\left(\begin{smallmatrix} +10 \\ \uparrow \end{smallmatrix}\right)$ keys when setting up the phase offset of PM2 relative to PM1.

Parameters: None

Response: <CRD>

Returned values: FIN | MED | COAR

Pulse modulation commands

([SOURce][:MODulation]:PULM subsystem)

Pulse modulation source, control

Commands for:

- Confirming pulse modulation source
- Turning pulse modulation on/off.

[SOURce]
[:MODulation]
:PULM
:SOURce\
:STATE\
?

[SOURCE][:MODulation]:PULM:SOURce

Description: Sets the source that is to generate pulse modulation: this source can only be external.

Parameters: <CPD>

Valid values: EXTernal

*RST sets: EXT

[SOURCE][:MODulation]:PULM:SOURce?

Description: Returns that the source for pulse modulation is external.

Parameters: None

Response: <CRD>

Returned values: EXT

[SOURCE][:MODulation]:PULM:STATE

Description: Adds Pulse to the set of active modulations, or removes Pulse from it: see Fig. 4-1 on page 4-19.

Parameters: <Boolean>

Valid values: OFF | ON | 0 | 1

*RST sets: OFF

[SOURCE][:MODulation]:PULM:STATE?

Description: Queries whether the Pulse path is off (0) or on (1).

Parameters: None

Response: <Boolean>

Returned values: 0 | 1

Power commands

([SOURce]:POWER subsystem)

ALC, carrier level, carrier level sweeping, level steps, offsets, max. RF level

Commands for:

- Configuring the ALC's bandwidth and state
- Setting carrier level and step size
- Setting compensation for external losses (offsets)
- Setting an RF output limit
- Setting sweep parameters.

```
[SOURce]
:POWER
:ALC
:BW\?
:FROZen
:[MODE]\?
:SEARCh
[:STATE]\?
[:LEVel]
[:IMMediate]
[:AMPLitude]\?
:OFFSet
:ATTenuation\?
[:GAIN]\?
:LOSS\?
:STATE\?
:STEP
[:INCRement]\?
:LIMit
[:AMPLitude]\?
:MODE\?
:OPTimisation\?
:QRFNull
:SWEep
:DWEL\?
:MANual\?
:START\?
:STEP\?
:STOP\?
```

[SOURCE]:POWER:ALC:BW

Description: Sets the ALC bandwidth for optimum performance.

Parameters: <CPD>

Valid values: AUTO | MODerate | NARRow | BROad

*RST sets: AUTO

[SOURCE]:POWER:ALC:BW?

Description: Returns the ALC bandwidth setting.

Parameters: None

Response: <CRD>

Returned values: AUTO | MODerate | NARR | BRO

[SOURCE]:POWER:ALC:FROZEN[:MODE]

Description: Sets the power search method in ALC frozen mode.

Parameters: <CPD>

Valid values: AUTO | MANual

*RST sets: AUTO

[SOURCE]:POWER:ALC:FROZEN[:MODE]?

Description: Returns the power search method in ALC frozen mode.

Parameters: None

Response: <CRD>

Returned values: AUTO | MAN

[SOURCE]:POWER:ALC:FROZEN:SEARCH

Description: Triggers a power search in ALC manual frozen mode.

[SOURce]:POWER:ALC[:STATE]

Description: Sets the ALC state for optimum performance.

Parameters: <CPD>

Valid values: AUTO | NORMal | AM | FROZen | SCALed

*RST sets: NORMal

[SOURce]:POWER:ALC[:STATE]?

Description: Returns the ALC state.

Parameters: None

Response: <CRD>

Returned values: AUTO | NORM | AM | FROZ | SCAL

[SOURce]:POWER[:LEVEl][:IMMediate][:AMPLitude]

Description: Sets the carrier level.

Parameters: <numeric_value>

Valid values: <NRf> | MAXimum | MINimum | UP | DOWN | RETurn | REFerence

Set by value, to maximum or minimum, stepping up or down, returning to the last full setting, or setting the current value to the last full setting.

<NRf> is in units set by :UNIT:POW or :UNIT:VTYP on page 4-172.

*RST sets: MIN

[SOURce]:POWER[:LEVEl][:IMMediate][:AMPLitude]?

Description: Queries the carrier level by value.

Parameters: None

Response: <NR2>

Returned values:

[SOURce]:POWER[:LEVel][:IMMediate][:AMPLitude]:OFFSet :ATTenuation

Description: Sets the external attenuation value for power offset.

Note that gain, attenuation and system loss are added together to give the overall offset.

Actual RF output power = displayed RF level – gain value + attenuation value + system loss value.

Parameters: <numeric_value>

Valid values: <NRf>(dB) | MINimum | MAXimum

*RST sets: 0 dB

[SOURce]:POWER[:LEVel][:IMMediate][:AMPLitude]:OFFSet :ATTenuation?

Description: Returns the external attenuation value for power offset.

Parameters: None

Response: <NR2>

Returned values: Attenuation level (dB)

[SOURce]:POWER[:LEVel][:IMMediate][:AMPLitude]:OFFSet[:GAIN]

Description: Sets the external gain value for power offset.

Note that gain, attenuation and system loss are added together to give the overall offset.

Actual RF output power = displayed RF level – gain value + attenuation value + system loss value.

Parameters: <numeric_value>

Valid values: <NRf>(dB) | MINimum | MAXimum

*RST sets: 0 dB

[SOURce]:POWER[:LEVel][:IMMediate][:AMPLitude]:OFFSet[:GAIN]?

Description: Returns the external gain value for power offset.

Parameters: None

Response: <NR2>

Returned values: Gain level (dB)

[SOURce]:POWER[:LEVel][:IMMediate][:AMPLitude]:OFFSet:LOSS

Description: Sets the external system loss value for power offset.

Note that gain, attenuation and system loss are added together to give the overall offset.

Actual RF output power = displayed RF level – gain value + attenuation value + system loss value.

Parameters: <numeric_value>

Valid values: <NRf>(dB) | MINimum | MAXimum

*RST sets: 0 dB

[SOURce]:POWER[:LEVel][:IMMediate][:AMPLitude]:OFFSet:LOSS?

Description: Returns the external system loss value for power offset.

Parameters: None

Response: <NR2>

Returned values: Loss level (dB)

[SOURce]:POWER[:LEVel][:IMMediate][:AMPLitude]:OFFSet:STATE

Description: Sets the carrier level offset on or off.

Parameters: <Boolean>

Valid values: OFF | ON | 0 | 1

*RST sets: OFF

[SOURce]:POWER[:LEVel][:IMMediate][:AMPLitude]:OFFSet:STATE?

Description: Queries whether the carrier level offset is off (0) or on (1).

Parameters: None

Response: <Boolean>

Returned values: 0 | 1

[SOURCE]:POWER[:LEVEL][:IMMEDIATE][:AMPLITUDE]:STEP[:INCREMENT]

Description: Sets the step size for carrier level.

Parameters: <numeric_value>

Valid values: <NRf>(dB) | MAXimum | MINimum

*RST sets: 1 dB

[SOURCE]:POWER[:LEVEL][:IMMEDIATE][:AMPLITUDE]:STEP[:INCREMENT]?

Description: Queries the step size for carrier level.

Parameters: None

Response: <NR2>

Returned values: Carrier level step size in dB

[SOURCE]:POWER:LIMIT[:AMPLITUDE]

Description: Sets the maximum RF level limit.

Parameters: <numeric_value>

Valid values: <NRf>(dB) | MAXimum | MINimum

*RST sets: MAX

[SOURCE]:POWER:LIMIT[:AMPLITUDE]?

Description: Queries the maximum RF level limit.

Parameters: None

Response: <NR2>

Returned values: Power level limit, in the units set on page 4-172

[SOURCE]:POWER:MODE

Description: Sets the mode of the carrier level operation.

Parameters: <CPD>

Valid values: FIXed | SWEep | LIST

*RST sets: FIX

[SOURCE]:POWER:MODE?

Description: Returns the mode of carrier level operation.

Parameters: None

Response: <CRD>

Returned values: FIX | SWE | LIST

[SOURCE]:POWER:OPTimisation

Description: Sets RF power optimization by selecting the appropriate noise mode.

Parameters: <CPD>

Valid values: AUTO | POWer | NOise | ACP

AUTO sets the optimum mode automatically, depending on RF level.

POW sets the maximum possible output power.

NO optimizes the output level for low noise.

ACP optimizes the output level for low ACP.

*RST sets: AUTO

[SOURCE]:POWER:OPTimisation?

Description: Queries the RF power optimization.

Parameters: None

Response: <CRD>

Returned values: AUTO | POW | NO | ACP

[SOURce]:POWER:QRFNull

Description: Optimizes RF level accuracy performance.

Parameters: none

Valid values: none

[SOURce]:POWER:SWEep:DWELI

Description: Sets the time per sweep step for carrier level.

Parameters: <numeric_value>

Valid values: <NRf>(s) | MAXimum | MINimum

*RST sets: 50 ms

[SOURce]:POWER:SWEep:DWELI?

Description: Queries the time per sweep step for carrier level.

Parameters: None

Response: <NR2>

Returned values: Time per sweep step in s

[SOURce]:POWER:SWEep:MANual

Description: Sets the output power sweep level.

Parameters: <numeric_value>

Valid values: <NRf>(dB) | MAXimum | MINimum | UP | DOWN

Set by value, to maximum or minimum, or stepping up or down.

<level> is in units set by :UNIT:POW or :UNIT:VTYP on page 4-172.

[SOURce]:POWER:SWEep:MANual?

Description: Queries the value of the output power sweep level.

Parameters: None

Response: <NR2>

Returned values: Power level, in the units set on page 4-172

[SOURce]:POWER:SWEEp:START

Description: Sets the start level for a power sweep.

Parameters: <numeric_value>

Valid values: <NRf>(dB) | MAXimum | MINimum

*RST sets: MIN

[SOURce]:POWER:SWEEp:START?

Description: Queries the start level for a power sweep.

Parameters: None

Response: <NR2>

Returned values: Start level, in the units set on page 4-172

[SOURce]:POWER:SWEEp:STEP

Description: Sets the step level for a power sweep.

Parameters: <numeric_value>

Valid values: <NRf>(dB) | MAXimum | MINimum

*RST sets: MAX

[SOURce]:POWER:SWEEp:STEP?

Description: Queries the step level for a power sweep.

Parameters: None

Response: <NR2>

Returned values: Step level, in the units set on page 4-172

[SOURce]:POWER:SWEEP:STOP

Description: Sets the stop level for a power sweep.

Parameters: <numeric_value>

Valid values: <NRf>(dB) | MAXimum | MINimum

*RST sets: MAX

[SOURce]:POWER:SWEEP:STOP?

Description: Queries the final level for a power sweep.

Parameters: None

Response: <NR2>

Returned values: Stop level, in the units set on page 4-172

Sweep commands

([SOURce]:SWEep subsystem)

Sweep handling and triggering

Commands for:

- Controlling operation of a frequency or power sweep
- Setting the sweep trigger mode and slope.

[SOURce]
:SWEep
:ABORt
:CONTInue
:INITiate
:OPERation\?
:PAUSe
:RESet
:TRIGger
[:MODE]\?
:SLOPe\?

[SOURce]:SWEep:ABORt

Description: Stops the sweep immediately.

Parameters: None

[SOURce]:SWEep:CONTInue

Description: Continues a paused sweep.

Parameters: None

[SOURce]:SWEep:INITiate

Description: Starts a sweep.

Parameters: None

[SOURce]:SWEep:OPERation

Description: Sets whether the sweep mode is single or continuous.

Parameters: <CPD>

Valid values: SINGle | CONTInuous

*RST sets: SING

[SOURce]:SWEep:OPERation?

Description: Returns whether the sweep mode is single or continuous.

Parameters: None

Response: <CRD>

Returned values: SING | CONT

[SOURce]:SWEep:PAUSE

Description: Pauses the sweep.

Parameters: None

[SOURce]:SWEep:RESet

Description: Resets the sweep to its starting value of power or frequency.

Parameters: None

[SOURce]:SWEep:TRIGger[:MODE]

Description: Sets the trigger mode to off, start, start then stop, or step.

Parameters: <CPD>

Valid values: OFF | START | SSTOP | STEP

*RST sets: OFF

[SOURce]:SWEep:TRIGger[:MODE]?

Description: Queries the trigger mode for the sweep.

Parameters: None

Response: <CRD>

Returned values: OFF | STAR | SSTOP | STEP

[SOURce]:SWEep:TRIGger:SLOPe

Description: Sets the polarity of the sweep trigger.

Parameters: <CPD>

Valid values: POSitive | NEGative

*RST sets: POS

[SOURce]:SWEep:TRIGger:SLOPe?

Description: Queries the polarity of the sweep trigger.

Parameters: None

Response: <CRD>

Returned values: POS | NEG

1

2

3

4

Instrument system-level commands

(SYSTEM subsystem)

Ethernet setup, GPIB address, RS-232 setup, error queue, keyboard locking, SCPI/2023 commands, power-up and memory handling, touch screen on/off, SCPI version

Commands for:

- Setting the instrument's Ethernet address, DHCP and hostname
- Setting the instrument's GPIB address, baud rate and serial interface parameters
- Setting keyboard locking
- Setting the default command set
- Setting power-on memory location parameters
- Setting the default store locations for save/recall operations

SYSTem

- :COMMunicate**
- :ETHernet**
- :ADDRess\?** Ethernet address
- :AUTO\?** Enable DHCP
- :HNAME\?** Hostname
- :GPIB**
- [:SELF]**
- :ADDRess\?** GPIB address
- :REMote\?**
- :SERial** RS-232 setup
- :BAUD\?**
- :CONTRol**
- :HANDshake\?**
- :PARity**
- :[TYPE]\?**
- :SBITs\?**
- :ERRor**
- :ALL?**
- :CODE**
- :ALL?**
- [:NEXT]?**
- :COUNT?**
- [:NEXT]?**
- :HELP**
- HEADers?**
- :KLOCK\?** Keyboard locking
- :LANGuage\?** SCPI or 2023 commands
- :PON**
- :MEMory\?** Power-on memory store
- :TYPE\?** Power-on memory location
- :PRESet**
- :SETTings**
- :FULL**
- :CLEar**
- :ALL**
- :RECALL**
- :SAVE**

SYSTem:COMMunicate:ETHernet:ADDRESS

Description: Sets the instrument's Ethernet address.

This command is rejected with a 'settings conflict' if DHCP is enabled.

Parameters: <string parameter data>,<string parameter data>

Valid values: NetMask and IP address, both in dotted quad format (for example, 255.255.255.0)

*RST sets: No effect

SYSTem:COMMunicate:ETHernet:ADDRESS?

Description: Returns the current NetMask and IP address in use, even if DHCP is enabled.

Parameters: None

Response: <string>,<string>

Returned values: Current NetMask and IP addresses

SYSTem:COMMunicate:ETHernet:AUTO

Description: Enables or disables the use of DHCP to set network parameters.

Parameters: <Boolean>

Valid values: ON | OFF | 1 | 0

*RST sets: No effect

SYSTem:COMMunicate:ETHernet:AUTO?

Description: Returns the DHCP state.

Parameters: None

Response: <Boolean>

Returned values: 1 | 0

SYSTEM:COMMunicate:ETHernet:HNAME

Description: Sets the host name that appears in DHCP server logs.

Parameters: <string parameter data>

Valid values: Host name

*RST sets: No effect

SYSTEM:COMMunicate:ETHernet:HNAME?

Description: Returns the instrument's host name.

Parameters: None

Response: <string>

Returned values: Host name

SYSTEM:COMMunicate:ETHernet:MADDRESS?

Description: Returns the Ethernet MAC address.

Parameters: None

Response: <string>

Returned values: For example, "00:50:31:04:01:02"

SYSTEM:COMMunicate:GPIB[:SELF]:ADDRESS

Description: Sets the instrument's GPIB address.

This command is only actioned once the EOM at the end of the message has been received and all outstanding query responses have been read.

Parameters: <numeric_value>

Valid values: Valid GPIB address

*RST sets: No effect on the GPIB address set

SYSTEM:COMMunicate:GPIB[:SELF]:ADDRESS?

Description: Returns the instrument's GPIB address.

Parameters: None

Response: <NR1>

Returned values: Integer

SYSTEM:COMMunicate:REMOte

Description: Selects the remote operation interface.

This command is only actioned once the EOM at the end of the message has been received and all outstanding query responses have been read.

Parameters: <CPD>

Valid values: GPIB | RS232 | Ethernet

*RST sets: No effect

SYSTEM:COMMunicate:REMOte?

Description: Returns the remote operation interface that the instrument uses.

Parameters: None

Response: <CRD>

Returned values: GPIB | RS232 | ETH

SYSTEM:COMMunicate:SERial:BAUD

Description: Sets the baud rate of the serial interface.

This command is only actioned once the EOM at the end of the message has been received and all outstanding query responses have been read.

Parameters: <numeric_value>

Valid values: 300 | 600 | 1200 | 2400 | 4800 | 9600

*RST sets: No effect on the set baud rate.

SYSTEM:COMMunicate:SERial:BAUD?

Description: Returns the baud rate of the serial interface.

Parameters: None

Response: <NR1>

Returned values: 300 | 600 | 1200 | 2400 | 4800 | 9600

SYSTEM:COMMunicate:SERial:CONTrol:HANDshake

Description: Sets the serial interface's handshake protocol.

This command is only actioned once the EOM at the end of the message has been received and all outstanding query responses have been read.

Parameters: <CPD>

Valid values: OFF | HW | SW | BOTH

*RST sets: No effect on the handshake set.

SYSTEM:COMMunicate:SERial:CONTrol:HANDshake?

Description: Returns the serial interface's hardware handshake.

Parameters: None

Response: <CRD>

Returned values: OFF | HW | SW | BOTH

SYSTEM:COMMunicate:SERial:PARity:[TYPE]

Description: Sets the serial interface's parity type.

This command is only actioned once the EOM at the end of the message has been received and all outstanding query responses have been read.

Parameters: <CPD>

Valid values: EVEN | ODD | NONE

*RST sets: No effect on the parity type set.

SYSTEM:COMMunicate:SERial:PARity:[TYPE]?

Description: Returns the serial interface's parity type.

Parameters: None

Response: <CRD>

Returned values: EVEN | ODD | NONE

SYSTEM:COMMunicate:SERial:SBITs

Description: Sets the number of stop bits that the serial interface uses.

This command is only actioned once the EOM at the end of the message has been received and all outstanding query responses have been read.

Parameters: <numeric_value>

Valid values: 1 | 2

*RST sets: No effect on the number of stop bits set.

SYSTEM:COMMunicate:SERial:SBITs?

Description: Returns the number of stop bits that the serial interface uses.

Parameters: None

Response: <NR1>

Returned values: 1 | 2

SYSTEM:ERROR:ALL?

Description: Queries the error queue for all unread items, and removes them from the queue.

Parameters: None

Response: <NR1>,<CRD>

Returns a comma-separated list of number, string pairs in FIFO order. If the queue is empty, the response is 0, 'No error'.

SYSTEM:ERROR:CODE[:ALL]?

Description: Queries the error queue for all unread items, and removes them from the queue.

Parameters: None

Response: <NR1>,...,<NR1>

Returns a comma-separated list of only the error/event code numbers in FIFO order. If the queue is empty, the response is 0.

SYSTEM:ERROR:CODE[:NEXT]?

Description: Queries the error queue for the next item, and removes it from the queue.

Parameters: None

Response: <NR1>

Returns the error code only, as an integer. If the queue is empty, the response is 0.

SYSTem:ERRor:COUNT?

Description: Queries the error queue for the number of unread items.

Parameters: None

Response: <NR1>

If the queue is empty, the response is 0.

SYSTem:ERRor[:NEXT]?

Description: Queries the error queue for the next unread item, and removes it from the queue.

Parameters: None

Response: <NR1>,<CRD>

Returns a number and string. If the queue is empty, the response is 0, 'No error'.

SYSTem:HELP:HEADers?

Description: Returns a list of the instrument command headers.

Parameters: None

Response: <arbitrary block response data>

SYSTem:KLOCK

Description: Locks and unlocks the keyboard. When the keyboard is locked, the  soft box and the [LOCAL] key still function.

Parameters: <Boolean>

Valid values: ON | OFF | 1 | 0

*RST sets: OFF

SYSTem:KLOCK?

Description: Queries whether the keyboard is locked (1) or unlocked (0).

Parameters: None

Response: <Boolean>

Returned values: 0 | 1

SYSTEM:LANGUage

Description: Configures the instrument to function with either the SCPI-like command set or the 2023 command set and status reporting.

This command is only actioned once the EOM at the end of the message has been received and all outstanding query responses have been read.

Follow any change of language with *RST to clear status registers.

Parameters: <CPD>

Valid values: SCPI | IFR2023

*RST sets: No effect on the language set.

SYSTEM:LANGUage?

Description: Returns the command set that the instrument is to work with.

Parameters: None

Response: <CRD>

Returned values: SCPI | IFR2023

SYSTEM:PON:MEMory

Description: Specifies a user-defined power-on memory store number.

Parameters: <numeric_value>

Valid values: Valid store number.

*RST sets: No effect on the store number set.

SYSTEM:PON:MEMory?

Description: Returns the power-on memory number.

Parameters: None

Response: <NR1>

Returned values: Store number.

SYSTem:PON:TYPE

Description: Selects power-on either from the default memory location (factory-preset) or one specified by :SYSTem:PON:MEMory above.

Parameters: <CPD>

Valid values: DEFault | MEMory

*RST sets: No effect on the language set.

SYSTem:PON:TYPE?

Description: Queries whether the instrument powers up from the default memory location or one specified by :SYSTem:PON:MEMory above.

Parameters: None

Response: <CRD>

Returned values: DEF | MEM

SYSTem:PRESet

Description: Returns the instrument to its default state (page 3-156).

Parameters: None

SYSTem:SETTings:FULL:CLEAr:ALL

Description: Clears all user-defined memory locations.

Parameters: none

SYSTem:SETTings:FULL:RECall

Description: Recalls the contents of the specified memory location.

Parameters: <numeric_value>

Valid values: Valid store number | UP | DOWN

SYSTem:SETTings:FULL:SAVE

Description: Save the current configuration to the memory location.

Parameters: <numeric_value>

Valid values: Valid store number.

Measurement unit commands

(UNIT subsystem)

Output level/voltage units

Commands for:

- Setting the units for output level
- Setting the voltage type for absolute/relative units.

:UNIT

:POWer\?

:VOLTTYPE\?

UNIT:POWer

Description: Sets the units for the output level, for the remote interface only. Local measurement units remain as set on the instrument's front panel.

Parameters: <CPD>

Valid values: DBM | DBV | DBMV | DBUV | V | MV | UV |

*RST sets: DBM

UNIT:POWer?

Description: Queries the units used for output level.

Parameters: None

Response: <CRD>

Returned values: DBM | DBV | DBMV | DBUV | V | MV | UV |

UNIT:VOLTYPe

Description: Sets the voltage type to be used for absolute and relative voltage units: DBV, DBMV, DBUV, V, MV, UV.

Parameters: <CPD>

Valid values: PD | EMF

*RST sets: Has no effect.

UNIT:VOLTYPe?

Description: Queries the voltage type used for voltage units.

Parameters: None

Response: <CRD>

Returned values: PD | EMF

Calibration commands

(CALibration subsystem)

Most calibration commands are included in the Maintenance Manual, as they are likely to be used only at routine calibration intervals or after servicing. The following commands may however be useful during everyday operation.

CALibration

:IQUser

:ADJust

:MODE\?

:MULTi

:BAND

:START\?

:STOP\?

:CLEar

:OPERation\?

:SPAN\?

CALibration:IQUSer:ADJust

Description: Performs a user IQ calibration at the current settings.

CALibration:IQUSer:MODE

Description: Sets whether user IQ calibration is done at a spot frequency; over a band; over up to four bands; or at the frequencies set up for list mode operation.

Parameters: <CPD>

Valid values: SPOTfreq | SPANfreq | MULTiband | LISTfreq

CALibration:IQUSer:MODE?

Description: Queries whether user IQ calibration is done at a spot frequency; over a band; over up to four bands; or at the frequencies set up for list mode operation.

Parameters: None

Response <CRD>

Returned values: SPOT | SPAN | MULT | LIST

CALibration:IQUSer:MULTi:BAND:START

Description: Sets the band number and start frequency for the user IQ calibration.

Parameters: <NRf>,<NRf>
<band number>,<frequency>

Valid values: <0, 1, 2, 3>,<NRf> (Hz)

CALibration:IQUSer: MULTi:BAND:START?

Description: Queries the start frequency for a particular band used for user IQ calibration.

Parameters: <band number>

Response <NR2>

Returned values: Start frequency in Hz

CALibration:IQUSer:MULTi:BAND:STOP

Description: Sets the band number and stop frequency for the user IQ calibration.

Parameters: <NRf>,<NRf>
<band number>,<frequency>

Valid values: <0, 1, 2, 3>,<NRf> (Hz)

CALibration:IQUSer: MULTi:BAND:STOP?

Description: Queries the stop frequency for a particular band used for user IQ calibration.

Parameters: <band number>

Response <NR2>

Returned values: Stop frequency in Hz

CALibration:IQUSer:MULTi:BAND:CLEar

Description: Clears the start and stop frequencies in the specified band for user IQ calibration.

Parameters: <NRf>
<band number>

Valid values: <0, 1, 2, 3>

CALibration:IQUSer:OPERation

Description: Sets whether user IQ calibration starts automatically or manually.

Parameters: <CPD>

Valid values: AUTOMatic | MANual

CALibration:IQUSer:OPERation?

Description: Queries whether user IQ calibration starts automatically or manually.

Parameters: None

Response <CRD>

Returned values: AUTO | MAN

CALibration:IQUSer:SPAN

Description: Sets the span over which the user IQ calibration is done if SPANfreq mode above is selected.

Parameters: <CPD>

Valid values: SPAN20 | SPAN40 | SPAN80 | SPAN120

These values represent spans of ± 10 , 20, 40 or 60 MHz with respect to the carrier frequency.

CALibration:IQUSer:SPAN?

Description: Queries the span over which the user IQ calibration is done if SPANfreq mode above is selected.

Parameters: None

Response <CRD>

Returned values: SPAN20 | SPAN40 | SPAN80 | SPAN120

Diagnostic commands

(DIAGnostic subsystem)

Attenuator count, RPP trip count, elapsed operating time, hardware and system options, version and part numbers

Commands for:

- Counting the number of attenuator operations
- Counting the number of RPP operations
- Monitoring the total time of operation and elapsed time since a reset
- Checking the version and part number of the boot PROM
- Checking the versions of CPLD, control and data gate array for the ARB, driver and RF boards
- Reading the hardware and system options fitted.

DIAGnostic

:INFormation	
:BOOTrom	
:PNUMber?	Boot PROM part number
:VERSion?	Boot PROM version
:CCOunt	Cumulative count of...
:ATTenuator?	...number of attenuator operations
:PROTection?	...number of RPP trips
:EDEFinitions?	Define error messages
:ETIMe?	Operating time since last reset
:RESet	
:OTIMe?	Total operating time
:PLDevice	
:ARB	
:BOOT?	ARB boot CPLD version
:CONTRol?	ARB control gate array version
:DATA?	ARB data gate array version
:FGENERator?	ARB function generator fitted?
:CONTRol?	ARB function generator control gate array version
:DATA?	ARB function generator data gate array version
:DIQ	
:CPLD?	Differential IQ board CPLD version
:DRIVER	
:CPLD?	Driver board CPLD version
:FPGA?	Driver board gate array version
:RFBoard	
:CPLD?	RF board CPLD version
:FPGA?	RF board gate array version
:RTBB	
:CPLD?	Real-time baseband board CPLD version
:FPGA?	Real-time baseband board gate array version
:OPTions	
:SOURce?	Hardware options
:SYSTem?	System options

DIAGnostic:INFormation:BOOTrom:PNUMber?

Description: Queries the part number of the boot PROM.

Parameters: None

Response <CRD>

Returned values: Part number as a string.

DIAGnostic:INFormation:BOOTrom:VERSion?

Description: Queries the version number of the boot PROM.

Parameters: None

Response <CRD>

Returned values: Version number as a string.

DIAGnostic:INFormation:CCOunt:ATTenuator?

Description: Queries the cumulative total number of times that the mechanical attenuator has operated.

Parameters: None

Response <NR1>,<NR1>,<NR1>,<NR1>,<NR1>,<NR1>

Returned values: Number of operations of each attenuator pad.

DIAGnostic:INFormation:CCOunt:PROTection?

Description: Queries the number of times that the RPP has been activated since last reset.

Parameters: None

Response <NR1>

Returned values: Number of activations.

DIAGnostic:INFormation:EDEFinitions?

Description: Queries the error definitions, providing a listing of all possible current error messages.

Parameters: None

Response: <arbitrary block response data>

Returned values: List of errors in the format:
error type, error number, 'error description'
separated by line feeds.

DIAGnostic:INFormation:ETIMe?

Description: Queries how much time has passed since the last reset (see :RESet below).

Parameters: None

Response: <NR2>

Returned values: Number of hours (fractional part in 15 min intervals: 0.25, 0.50, 0.75).

DIAGnostic:INFormation:ETIMe:RESet

Description: Resets the elapsed time counter.

Parameters: None

DIAGnostic:INFormation:OTIMe?

Description: Queries the total number of operating hours.

Parameters: None

Response: <NR2>

Returned values: Number of hours (fractional part in 15 min intervals: 0.25, 0.50, 0.75)

DIAGnostic:INFormation:PLDevice:ARB:BOOT?

Description: Queries the version of the ARB's boot CPLD.

Parameters: None

Response: <NR1>

Returned values: Two hex. digits

DIAGnostic:INFormation:PLDevice:ARB:CONTROL?

Description: Queries the version of the ARB's control gate array.

Parameters: None

Response: <NR1>

Returned values: Four hex. digits

DIAGnostic:INFormation:PLDevice:ARB:DATA?

Description: Queries the version of the ARB's data gate arrays.

Parameters: None

Response: <NR1>

Returned values: Four hex. digits

DIAGnostic:INFormation:PLDevice:ARB:FGENERator?

Description: Queries whether the ARB function generator is present.

Parameters: None

Response: <boolean>

Returned values: 0 | 1

DIAGnostic:INFormation:PLDevice:ARB:FGENERator:CONTrol?

Description: Queries the version of the ARB function generator's control gate array.

Parameters: None

Response: <NR1>

Returned values: 0 to 65535, representing four hex. digits in decimal.

DIAGnostic:INFormation:PLDevice:ARB:FGENERator:DATA?

Description: Queries the version of the ARB function generator's data gate arrays.

Parameters: None

Response: <NR1>

Returned values: 0 to 65535, representing four hex. digits in decimal.

DIAGnostic:INFormation:PLDevice:DIQ:CPLD?

Description: Queries the version of the differential IQ board's CPLD.

Parameters: None

Response: <NR1>

Returned values: 0 to 255, representing two hex. digits in decimal.

DIAGnostic:INFormation:PLDevice:DRIVer:CPLD?

Description: Queries the version of the driver board's CPLD.

Parameters: None

Response: <NR1>

Returned values: Four hex. digits

DIAGnostic:INFormation:PLDevice:DRIVer:FPGA?

Description: Queries the version of the driver board's gate array.

Parameters: None

Response: <NR1>

Returned values: Four hex. digits

DIAGnostic:INFormation:PLDevice:RFBoard:CPLD?

Description: Queries the version of the RF board's CPLD.

Parameters: None

Response: <NR1>

Returned values: Two hex. digits

DIAGnostic:INFormation:PLDevice:RFBoard:FPGA?

Description: Queries the version of the RF board's gate array.

Parameters: None

Response: <NR1>

Returned values: Two hex. digits

DIAGnostic:INFormation:PLDevice:RTBB:CPLD?

Description: Queries the version of the RTBB board's CPLD.

Parameters: None

Response: <arbitrary ASCII response data>

Returned values: n.n (for example, 1.2)

DIAGnostic:INFormation:PLDevice:RTBB:FPGA?

Description: Queries the version of the RTBB board's gate arrays.

Parameters: <NRf>
 where 0 = phase program, 1 = frequency program, 2 = tones program

Response: < arbitrary ASCII response data >
 <part no.><date><version>

Returned values: "pppppp/ppp dd/dd/dd vn.nn"

DIAGnostic:OPTions:SOURCE?

Description: Reads the hardware options fitted. If no options are fitted, a '0' is returned. Otherwise, the response is up to six strings, separated by commas.

- Option 001 No attenuator
- Option 002 Mechanical attenuator
- Option 003 Electronic attenuator
- Option 005 Dual-channel ARB
- Option 008 Real-time baseband
- Option 009 Differential IQ outputs

Parameters: None

Response: <arbitrary ASCII response data>

Returned values: Options:string

DIAGnostic:OPTions:SYSTEM?

Description: Reads the system options fitted. If no options are fitted, a '0' is returned. Otherwise, the response is up to six strings, separated by commas.

- Option 006 Pulse modulation
- Option 007 Rear-panel outputs
- Option 020 2G CDMA license
- Option 021 2G and 3G CDMA license

Parameters: None

Response: <arbitrary ASCII response data>

Returned values: Options:string

Display commands

(DISPlay subsystem)

Screen blanking, contrast

Commands for:

- Blanking or unblanking different fields on the screen
- Setting display contrast.

DISPlay

:ANNOtation

Blanks all or selected (frequency/modulation/power) parts of display

[:ALL]?

:FREQUency\?

:MODUlation\?

:POWER\?

:CONTRast\?

DISPlay:ANNotation[:ALL]

Description: Blanks or unblanks all the display parameters together: Carrier Freq, RF Level, Mod Depth and Deviations, and Mod Freq.

Parameters: <Boolean>

Valid values: ON | OFF | 1 | 0

*RST sets: ON

DISPlay:ANNotation[:ALL]?

Description: Queries if all the display parameters are blanked (0) or unblanked (1).

Parameters: None

Response: <Boolean>

Returned values: 0 | 1

DISPlay:ANNotation:FREQuency

Description: Blanks or unblanks the Frequency display.

Parameters: <Boolean>

Valid values: ON | OFF | 1 | 0

*RST sets: ON

DISPlay:ANNotation:FREQuency?

Description: Queries if the Frequency display parameter is blanked (0) or unblanked (1).

Parameters: None

Response: <Boolean>

Returned values: 0 | 1

DISPlay:ANNotation:MODulation

Description: Blanks or unblanks the Modulation display.

Parameters: <Boolean>

Valid values: ON | OFF | 1 | 0

*RST sets: ON

DISPlay:ANNotation:MODulation?

Description: Queries if the Modulation display parameter is blanked (0) or unblanked (1).

Parameters: None

Response: <Boolean>

Returned values: 0 | 1

DISPlay:ANNotation:POWer

Description: Blanks or unblanks the RF Level display.

Parameters: <Boolean>

Valid values: ON | OFF | 1 | 0

*RST sets: ON

DISPlay:ANNotation:POWer?

Description: Queries if the RF Level display parameter is blanked (0) or unblanked (1).

Parameters: None

Response: <Boolean>

Returned values: 0 | 1

DISPlay:CONTRast

Description: Sets the contrast of the display.

Parameters: <numeric_value>

Valid values: 0 to 15 | MINimum | MAXimum

*RST sets: 8

DISPlay:CONTRast?

Description: Queries the contrast of the display.

Parameters: None

Response: <NR1>

Returned values: Display contrast setting, in the range 0 to 15

Virtual front panel commands

Virtual display and controls

Commands for:

- Controlling the virtual display
- Simulating keyboard and rotary control inputs.

VFPanel

:DATA
 :ALL\?
 [:PARTial?]
:KPRessed
:KRELeased
:PALette?
:PROTOcol?
:RCONtrol
[:STATE]
:TSPressed
:TSReleased

VFPanel:DATA:ALL?

Parameters: None

Response: <NR1>,<NR1>,<NR1>,<NR1>,<NR1>,<arbitrary block data>

Returned values: Left, top, length, height of the part of the display that has changed, the compression scheme selected and the display data for that part of the display.

Description: Returns the data for the whole display, unless the virtual display is not turned on.

Pixel data going from left to right and then top to bottom is packed into a byte array using a big endian packing scheme. This data can then be further compressed using a compression scheme previously selected.

VFPanel:DATA[:PARTial]?

Parameters: None

Response: <NR1>,<NR1>,<NR1>,<NR1>,<NR1>,<arbitrary block data>

Returned values: Left, top, length, height of the part of the display that has changed, the compression scheme selected and the display data for that part of the display.

Description: Returns the data for the part of the display that has changed since the last time this command was sent.

Pixel data going from left to right and then top to bottom is packed into a byte array using a big endian packing scheme (the most significant bit of the byte represents the leftmost pixel). This data can then be further compressed using a compression scheme previously selected by the :VFPanel:PROTocol? command.

VFPanel:KPRessed

Parameters: <CPD>

Valid values: PREV
NEXT
TAB
SUBMENU
SIGGEN
IQ
RECALL
UTIL
SWEEP
ANALOG
SAVE
DELTA
SEVEN
FOUR
ONE
ZERO
EIGHT
FIVE
TWO
POINT
NINE
SIX
THREE
MINUS
GHZ
MHZ
KHZ
HZ
UP
DOWN
KNOBSTEP
RFONOFF
MODONOFF
MODSRCONOFF
ERROR

Description: Simulates the depression of a key. The key is released when either a :VFPanel:KREleased command is sent or a 30-second timeout occurs. If the controller application wishes to keep the key pressed for longer than 30 seconds, then it should periodically repeat the :VFPanel:KPRessed command with the same key value.

VFPanel:KRELeased

Parameters: None

Description: Simulates the release of a key.

VFPPanel:PALette?

Parameters: None

Response: <NR1>,{<NR1>,<NR1>,<NR1>}

Returned values: Number of palette entries (2), followed by red, green and blue values for each entry.

Description: Returns the color palette employed by the instrument.

VFPPanel:PROTocol?

Parameters: <NRf>

Valid values: Bitfield — logical OR of all compression schemes supported by the soft front panel client.

Response: <NR1>,<NR1>,<NR1>,<NR1>

Returned values: Display length, display height, bits per pixel, preferred compression scheme.

The compression scheme is returned in this command solely in order to enable the controller to pre-load decompression handlers for optimization purposes.

Description: This command is used to read the details of the display type and determine a compression scheme that can be understood by both ends.

The parameter to the command indicates which compression schemes the controller is capable of handling. The fourth response value indicates which compression scheme the instrument has selected.

The compression scheme currently implemented is run length encoding (0x00000001). When this scheme is used, the first byte of the response data is the token. Thereafter, whenever a byte is read with the token value, the next two bytes represent the count and the repeated byte value respectively.

The soft front panel should always be able to handle a compression scheme of 0 (zero), meaning no compression.

VFPPanel:RCONtrol

Parameters: <NRf>

Valid values: -32768 to 32767

Description: Simulates the movement of the rotary control.

VFPanel[:STATe]

Parameters: <Boolean>

Valid values: OFF | ON | 0 | 1

Description: Enables or disables the generation of virtual display data.

If the display is already enabled when this command is sent with the ON state value, the bit in the status register indicating that the screen has changed is set and the next read of the display data returns the entire screen.

May be queried.

VFPanel:TSPressed

Parameters: <NRf>,<NRf>

Valid values: x and y co-ordinates — limited by size of display in pixels.

Description: Simulates the pressing of the touchscreen at the point on the display specified. This command is also sent when there is a need to simulate the movement of the pressed point.

The touchscreen is released when either a :VFPanel:TSReleased command is sent or a 30-second timeout occurs. If the controller application wishes to keep the touchscreen pressed for longer than 30 seconds, then it should periodically repeat the :VFPanel:TSPressed command with the same co-ordinate values.

VFPanel:TSReleased

Parameters: None

Description: Simulates the removal of pressure from the touch screen.

Status commands

(STATUS subsystem)

Commands for determining the state of the instrument

Because the status subsystem consists of many similar registers, it would be repetitive to list the commands for each here. Instead, common commands and queries are given, with the universal <StatReg> representing individual registers.

STATUS

<StatReg>
:CONDition?
:ENABle\
:EVENT?
:NTRansition\
:PTRansition\
:PRESet

where <StatReg> is:

:OPERation
:OPERation:TRIGger
:QUESTionable
:QUESTionable:CALibration
:QUESTionable:FREQuency
:QUESTionable:MODulation
:QUESTionable:MODulation:AM
:QUESTionable:MODulation:ARB
:QUESTionable:MODulation:DM
:QUESTionable:MODulation:FM
:QUESTionable:MODulation:IQ
:QUESTionable:MODulation:PM
:QUESTionable:MODulation:PULM
:QUESTionable:POWER
:QUESTionable:ROSCillator

STATUS:<StatReg>:CONDition?

Description: Reads the contents of the status register.

Parameters: None.

Response: <NR1>
Status register contents.

STATUS:<StatReg>:ENABle

Description: Sets the enable mask, which allows true conditions in the status event register to be reported in the summary bit. If a bit is '1' in the enable register and its associated event bit makes a transition to true, a positive transition will occur in the associated summary bit.

Parameters: <NRf>
Mask

Valid values: 0-7FFFH

STATUS:<StatReg>:ENABle?

Description: Reads the enable mask for the status register.

Parameters: [<NRf>]
[Mask]

Response: <NR1>
Mask

Returned values: 0-7FFFH

STATUS:<StatReg>:EVENT?

Description: Reads the contents of the event register associated with the operation status register.

Parameters: None.

Response: <NR1>
Event register contents.

Returned values: 0-7FFFH

STATUS:<StatReg>:NTRansition

Description: Sets the negative transition filter in the status register. Setting a bit in the negative transition filter causes a 1 to 0 transition in the corresponding bit of the associated condition register, causing a '1' to be written in the associated bit of the corresponding event register.

Parameters: <NRf>
Mask

Valid values: 0–7FFFH

STATUS:<StatReg>:NTRansition?

Description: Reads the negative transition mask for the status register.

Parameters: [<NRf>]
[Mask]

Response: <NR1>
Mask

Returned values: 0–7FFFH

STATUS:<StatReg>:PTRansition

Description: Sets the positive transition filter in the status register. Setting a bit in the positive transition filter causes a 0 to 1 transition in the corresponding bit of the associated condition register, causing a '1' to be written in the associated bit of the corresponding event register.

Parameters: <NRf>
Mask

Valid values: 0–7FFFH

STATUS:<StatReg>:PTRansition?

Description: Reads the positive transition mask for the status register.

Parameters: [<NRf>]
[Mask]

Response: <NR1>
Mask

Returned values: 0–7FFFH

STATUS:PRESet

Description: Sets the enable registers and transition filter registers to their preset conditions.

Parameters: None.

Status reporting

An instrument within a SCPI-based system contains a set of registers that reflect the current state of the instrument and whether a particular event has occurred. It is also sometimes necessary for an instrument to generate an alert if that condition exists or if that event has occurred.

The status registers contain information about the condition of the instrument. Using these registers, it is possible to find out, for example, whether an error has occurred with a command, if the local oscillator has locked, or if the external frequency standard is present. These registers can be used either by reading the contents directly when needed, or by configuring them to generate an interrupt signal (SRQ, service request) when the condition of interest occurs. The status system consists of readable ('questionable') registers, together with status, standard event and operation registers, as shown in Fig. 4-4. These registers are described below, and in greater detail on pages 4-203 onwards. Logic level '1' represents a set bit.

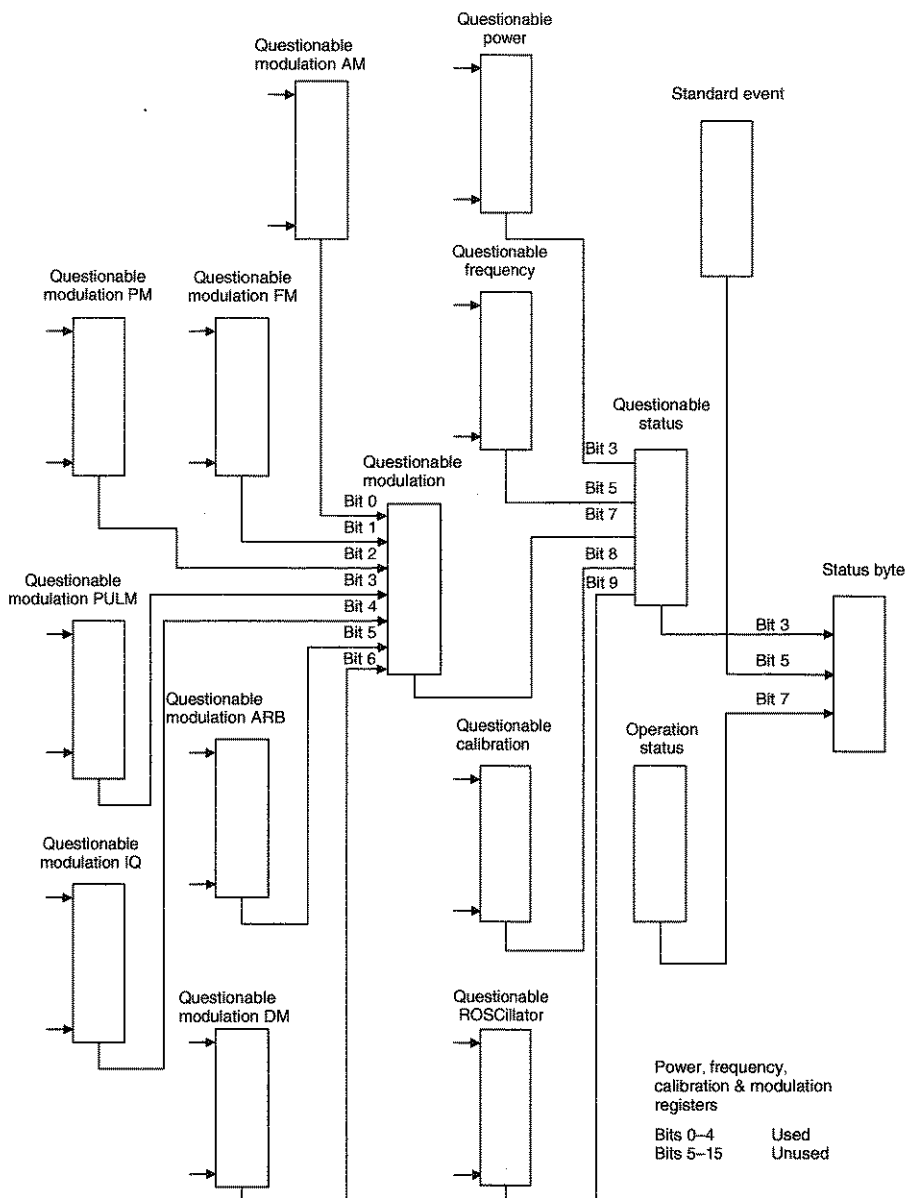

Fig. 4-4 Simplified status register structure

Status byte register. This 8-bit register (pages 4-203 and 4-204) is used to represent particular conditions or events in an instrument. The status byte register (defined by IEEE 488.1) is read by using the *STB? command or by serial poll. When read by serial poll, an SRQ (service request) is generated that alerts the controller. Associated with the status byte register is the service request enable register, which allows control over which bits of the status byte contribute towards the generation of the SRQ signal. When read by *STB?, bit 6 of the status byte is known as the *master summary status* function (MSS), and is the OR function of the other seven bits of the register.

Standard event register. This 8-bit register (page 4-207) extends the status reporting structure to cover various other events, defined by IEEE 488.2. The register is read by *ESR?. The standard event enable register allows control over which bits of the standard event register affect the summary bit output (ESB). The summary bit is recorded in bit 5 of the status byte.

Operation status register. This 16-bit register (page 4-209), defined in SCPI, further extends the status reporting structure by providing information about what the instrument is doing. It is read by the STATus:OPERation:CONDition? or STATus:OPERation[:EVENT]? command. The summary bit output of the register is recorded in bit 7 of the status byte.

Questionable status register. This 16-bit register (page 4-208), defined in SCPI, gives information about factors affecting the quality of signal generation. It is read by the STATus:QUESTionable:CONDition? or STATus:QUESTionable[:EVENT]? command. The summary bit output of the register is recorded in bit 3 of the status byte.

Questionable power status register. This 16-bit register (page 4-209) further extends the questionable status register by providing power condition information. It is read by the STATus:QUESTionable:POWer:CONDition? or STATus:QUESTionable:POWer[:EVENT]? command and recorded in bit 3 of the questionable status register.

Questionable frequency status register. This 16-bit register (page 4-210) further extends the questionable status register by providing frequency condition information. It is read by the STATus:QUESTionable:FREQuency:CONDition? or STATus:QUESTionable:FREQuency[:EVENT]? command and recorded in bit 5 of the questionable status register.

Questionable modulation status register. This 16-bit register (pages 4-210 to 4-213) further extends the questionable status register by providing modulation condition information from the AM, FM, PM, PULM, IQ and ARB and DM questionable modulation registers. It is read by the STATus:QUESTionable:MODulation:CONDition? or STATus:QUESTionable:MODulation[:EVENT]? command and recorded in bit 7 of the questionable status register.

Questionable calibration status register. This 16-bit register (page 4-214) further extends the questionable status register by providing calibration condition information. It is read by the STATus:QUESTionable:CALibration:CONDition? or STATus:QUESTionable:CALibration[:EVENT]? command and recorded in bit 8 of the questionable status register.

Questionable ROSCillator status register. This 16-bit register (page 4-214) further extends the questionable status register by providing reference oscillator condition information. It is read by the STATus:QUESTionable:ROSCillator:CONDition? or STATus:QUESTionable:ROSCillator[:EVENT]? command and recorded in bit 9 of the questionable status register.

The **output queue** (page 4-205) temporarily stores responses to query commands received by the instrument until they can be read by the controller. The **error queue** (page 4-205) temporarily stores up to 20 error messages. Each time the instrument detects an error, it places a message in the queue; each item contains an error number, defined in SCPI, and an error message. When the SYSTem:ERRor? query is sent, the message at the head of the error queue is moved to the output queue so it can be read by the controller.

Register structures

The operation and questionable register structures consist of condition, event, transition and enable registers.

The **condition registers** continuously monitor the instrument's hardware and firmware status. Bits in a condition register are not latched but are updated in real time (so that they represent the actual state of the instrument at all times) and are read by the above commands.

The bits of the **event registers** (read by `STATUS:OPERation:EVENT?` and `STATUS:QUEStionable:EVENT?`) are set on events. For example, the averaging bit in the operation register only indicates if the measurement is being performed with averaging enabled, while the associated event register shows that the averaging has completed.

A set of transition filters (**transition register**) control what type of change in a condition register will set the corresponding bit in the event register. The type of transition filter — negative, positive or both — is fixed for each bit. For example, the averaging bits in the operation register structure have negative transition filters so that the bits in the event register are set when averaging is complete. When the event register bits are set they remain set, even if the corresponding condition bits change. They are reset after being read by the query commands `STATUS:OPERation:EVENT?` and `STATUS:QUEStionable :EVENT?`, or when the `*CLS` (clear status) common command is issued. Transition registers are read-write, and are unaffected by query commands or `*CLS`.

The ability of each bit in the event registers to affect the summary bit in the status byte register can be enabled or disabled by corresponding bits in the event **enable registers**. These can be set and read by the commands/queries `STATUS:OPERation:ENABLE\?` and `STATUS:QUEStionable:ENABLE\?` The enabled bits are combined in a logical OR operation to produce the summary bit (summary bits are recorded in the instrument's status byte). Enable registers are cleared by `*CLS`.

The above status-reading commands return the decimal number equivalent of the register contents.

The events and conditions that are monitored by the instrument's status registers, and the commands for reading and writing to them, are described in more detail in 'Remote status reporting structure' on pages 4-203 and following.

Reading status information

As already stated, two techniques are used to interact with the status reporting structure:

Direct-read method. In many cases it is adequate and convenient for the controller simply to read the appropriate registers when necessary to determine the required status information. This technique does not involve the use of SRQ and therefore does not require any interrupt handling code in the application program. The following steps are used to monitor a condition:

Determine which register contains the bit that monitors the condition.

Send the query command that reads the register.

Examine the bit to see if the condition has changed.

The direct-read method works well when it is not necessary to know about changes the moment they occur. A program that uses this method to detect changes in a condition as soon as possible would need to continuously read the registers at very short intervals; the SRQ method is better suited to this type of need.

Service request (SRQ) method. In the SRQ method the instrument plays a more active role, in that it tells the controller when there has been a condition change without the controller asking. The following steps are required to monitor a condition:

Determine which register sets, and which of its bits monitors the condition.

Determine how that bit reports to the request service (RQS) bit of the status byte (some report directly while others may report indirectly through other register sets:).

Send remote commands to enable the bit that monitors the condition and to enable the summary bits that report the condition to the RQS bit.

Enable the controller to respond to service requests.

When the condition changes, the instrument sets its RQS bit (bit 6) and the GPIB's SRQ line; the controller is informed of the change as soon as it occurs. Setting the SRQ line informs the controller that a device on the bus requires service. The program then instructs the controller to perform a serial poll; each device on the bus returns the contents of its status byte register in response to this poll. The device whose RQS bit is set to '1' is the device that requested service. After the status byte is read the RQS bit is reset to '0'; the other bits are not affected.

Another reason for using SRQ is the need to detect errors in the various devices within the instrument. Since the timing of errors may not be known in advance, and it is not practical for the program to check the status of every device frequently, an interrupt handling routine can be used to detect and investigate any SRQ generated.

Remote status reporting structure

Status byte when read by *STB?

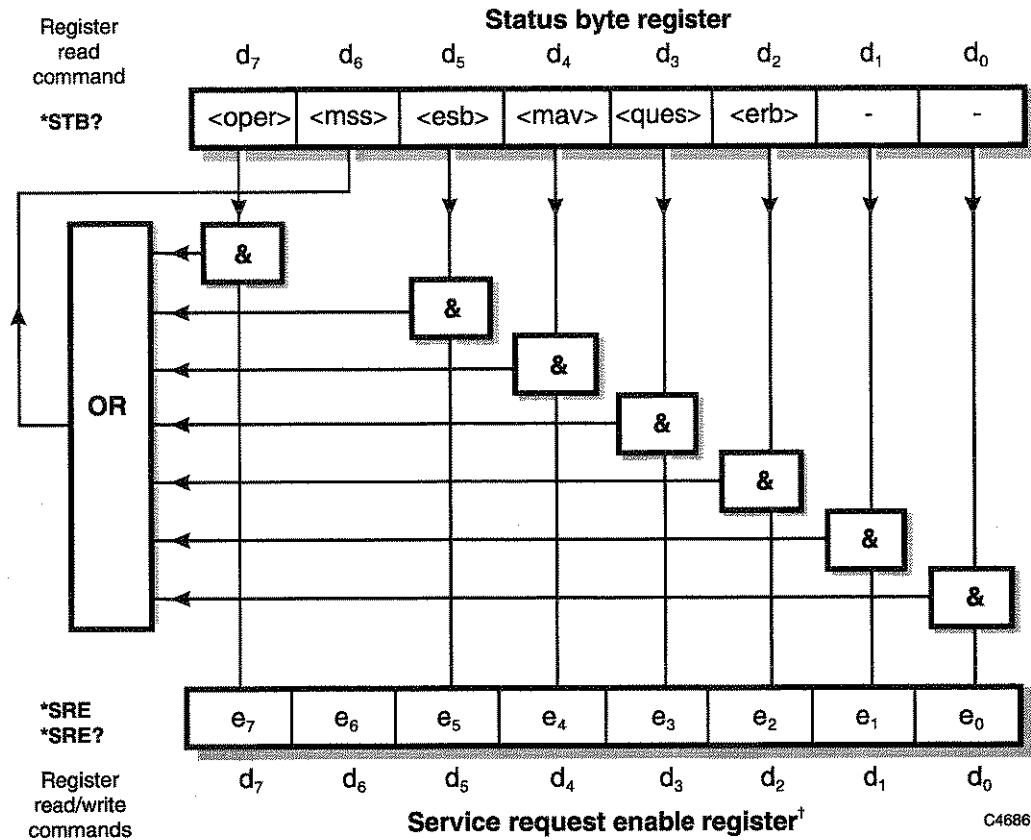

[†] Bit 6 in this register ignores data sent by *SRE and always returns '0' in response to *SRE?

<rqs>, <esb> and <mav> are defined in IEEE 488.2.

<erb> is a device-defined queue summary bit, indicating that the error queue is non-empty (see 'Queue flag details' on page 4-205).

<mss> is true when (status byte) AND (enable register) > 0.

<esb> is the standard event register summary bit.

<mav> is 'message available', indicating that the output queue is non-empty (see 'Queue flag details' on page 4-205).

<oper> is the operation status register summary bit.

<ques> is the questionable status register summary bit.

Note: The status byte register is not cleared by the *STB? query.

Status byte when read by serial poll

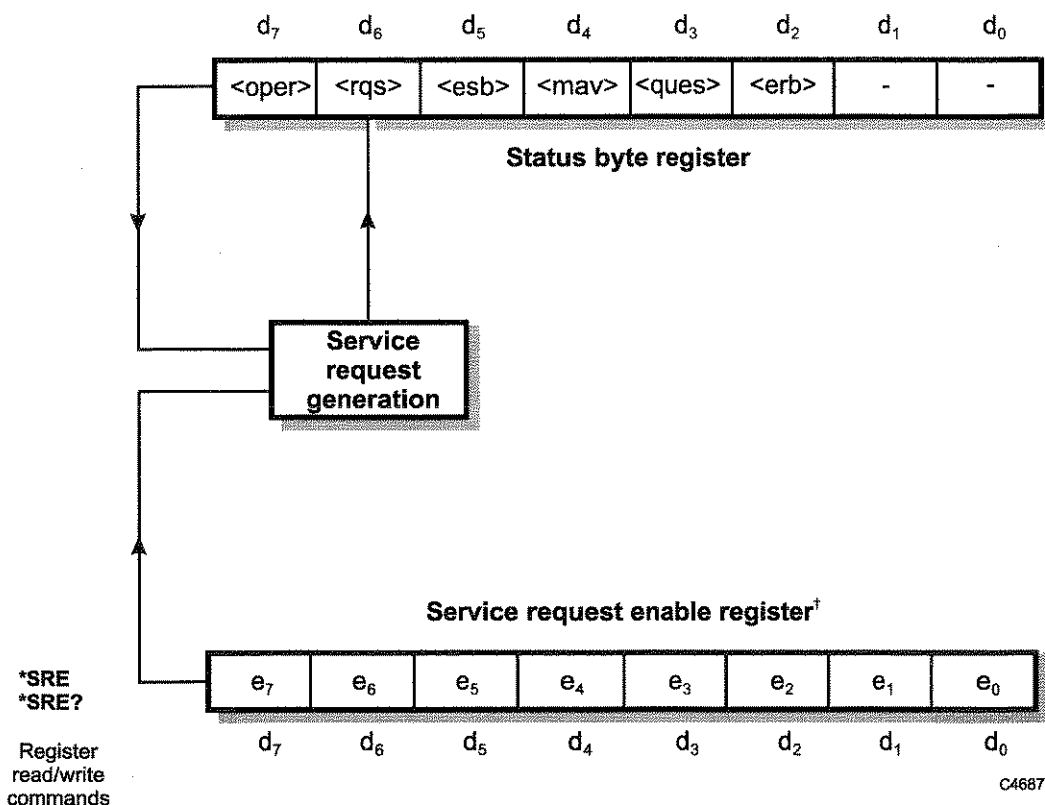

† Bit 6 in this register ignores data sent by *SRE and always returns '0' in response to *SRE?

<rqs>, <esb> and <mav> are defined in IEEE 488.2.

<erb> is a device-defined queue summary bit, indicating that the error queue is non-empty.

<rqs> is set by request for service and is cleared by the poll.

<esb> is the standard event register summary bit.

<mav> is 'message available', indicating that the output queue is non-empty.

<oper> is the operation status register summary bit.

<ques> is the questionable status register summary bit.

<rqs> (request for service) produces an SRQ at the controller. It is set by a change to either the status byte or the service enable register that results in a new reason for service. It is cleared when <mss> goes FALSE (no reason for service) or by serial poll.

Note: The status byte register is not cleared by the *STB? query.

Queue flag details

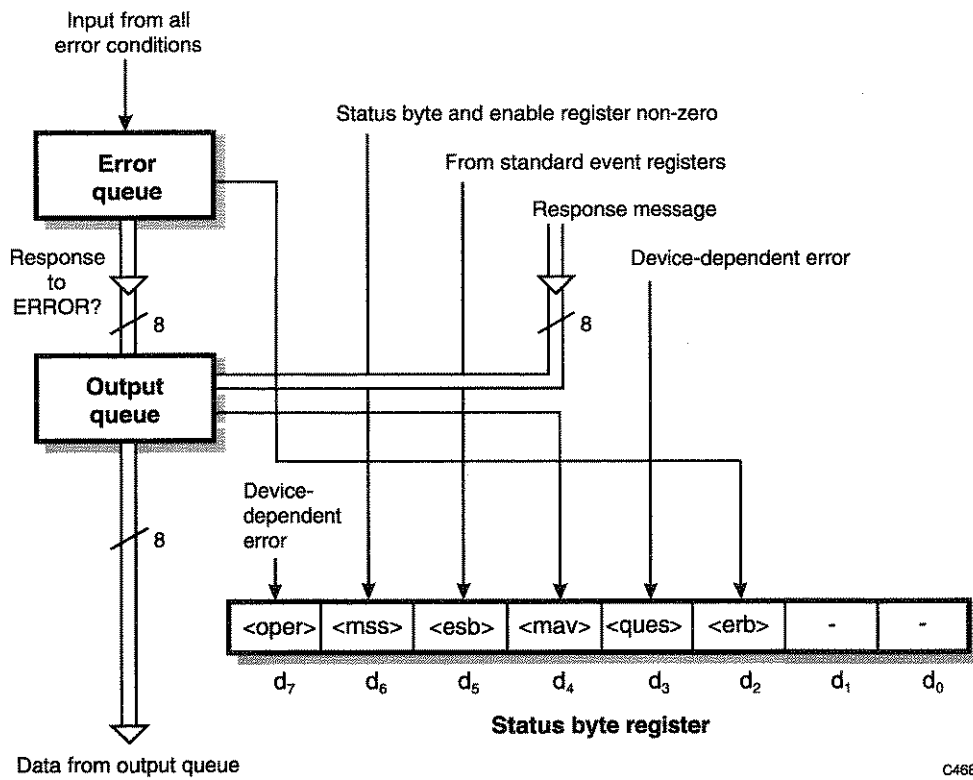

C4688

The <mav> status bit is set when one or more bytes are available to be read from the output queue. The <erb> status bit is set when one or more errors are present in the error queue. The ERROR? query will place an NR1 response message in the output queue, representing the error at the head of the queue. If the queue is empty, this message is '0'.

Status data structure — register model

Below is a generalized model of the register set which funnels the monitored data into a single summary bit to set the appropriate bit in the status byte.

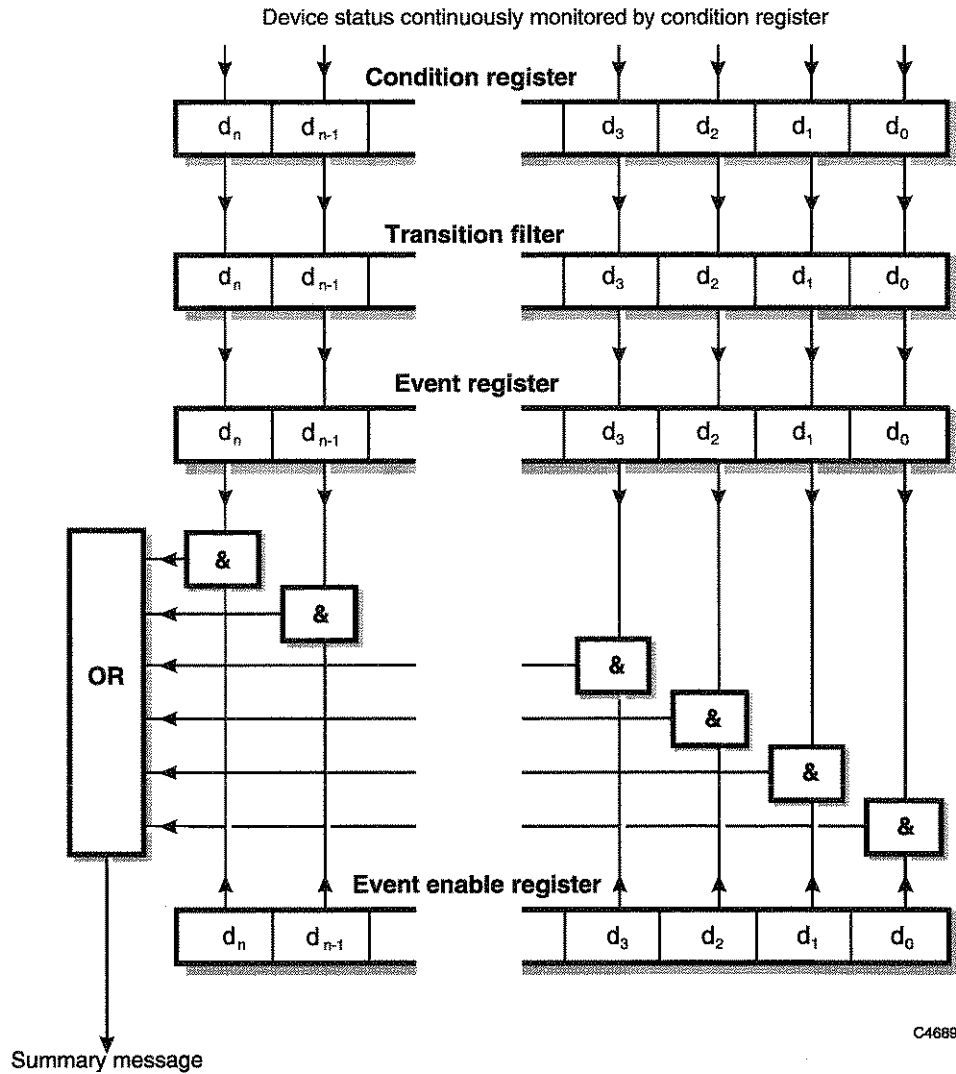

The condition register continuously monitors the device's status. If a query to read a condition register is provided, the response represents the status of the instrument at the moment the response is generated. A condition register cannot be written to.

The transition filter determines which transition of the condition register data bits will set the corresponding bit in the event register. The condition register data bits are pre-set as either positive or negative.

The bits in an event register are 'latched'. Once set they remain set, regardless of subsequent changes in the associated condition bit until the event register is cleared by being read or by the *CLS common command. Once cleared, an event register bit will only be set again if the appropriate change in the condition bit occurs.

The event enable register may be both written to and read from. It is bitwise AND-ed with the event register and if the result is non-zero the summary message is true, otherwise the summary message is false. Enable registers are not affected by *CLS but are however clear at power-on.

Standard event register

This register is defined by IEEE 488.2 and each bit has the meaning shown below:

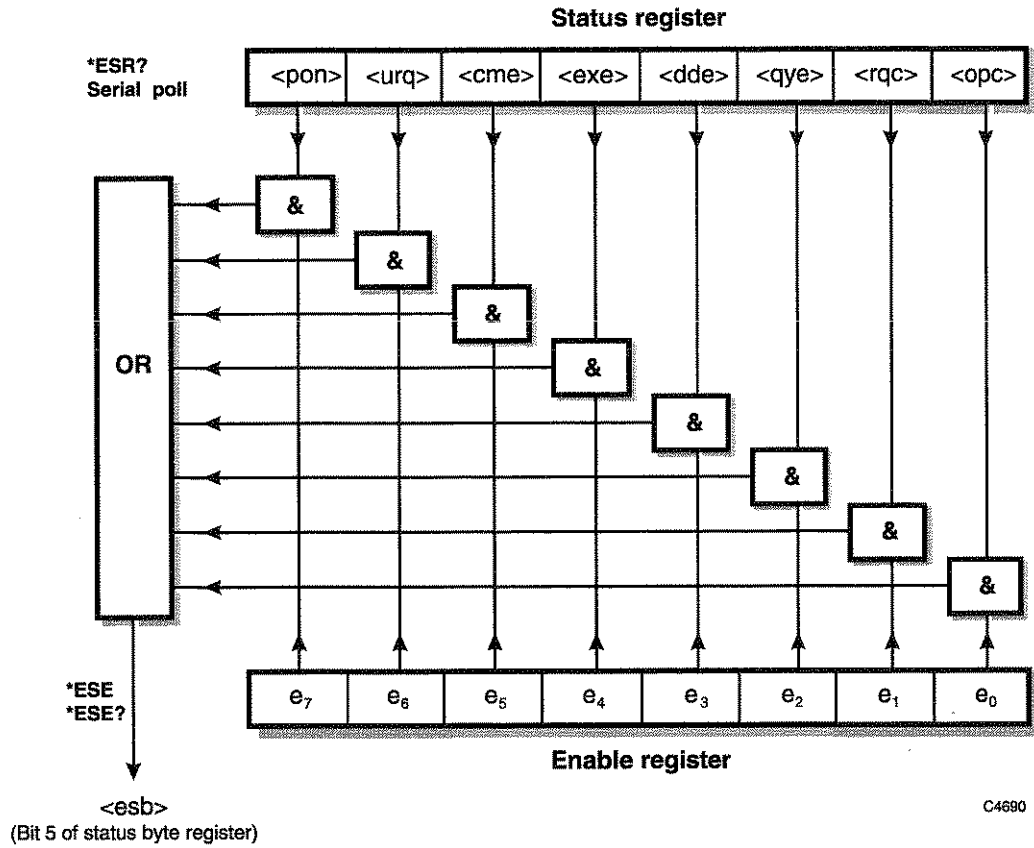

- <pon> power on
- <urq> user request – not implemented in this instrument
- <cme> command error
- <exe> execution error
- <dde> device-dependent error
- <qye> query error
- <rqc> request control – not implemented in this instrument
- <opc> operation complete – set in response to the *OPC command for synchronization.
- <esb> standard event register summary bit

Questionable status register

This is a device-dependent register and the bits have meanings as shown below.

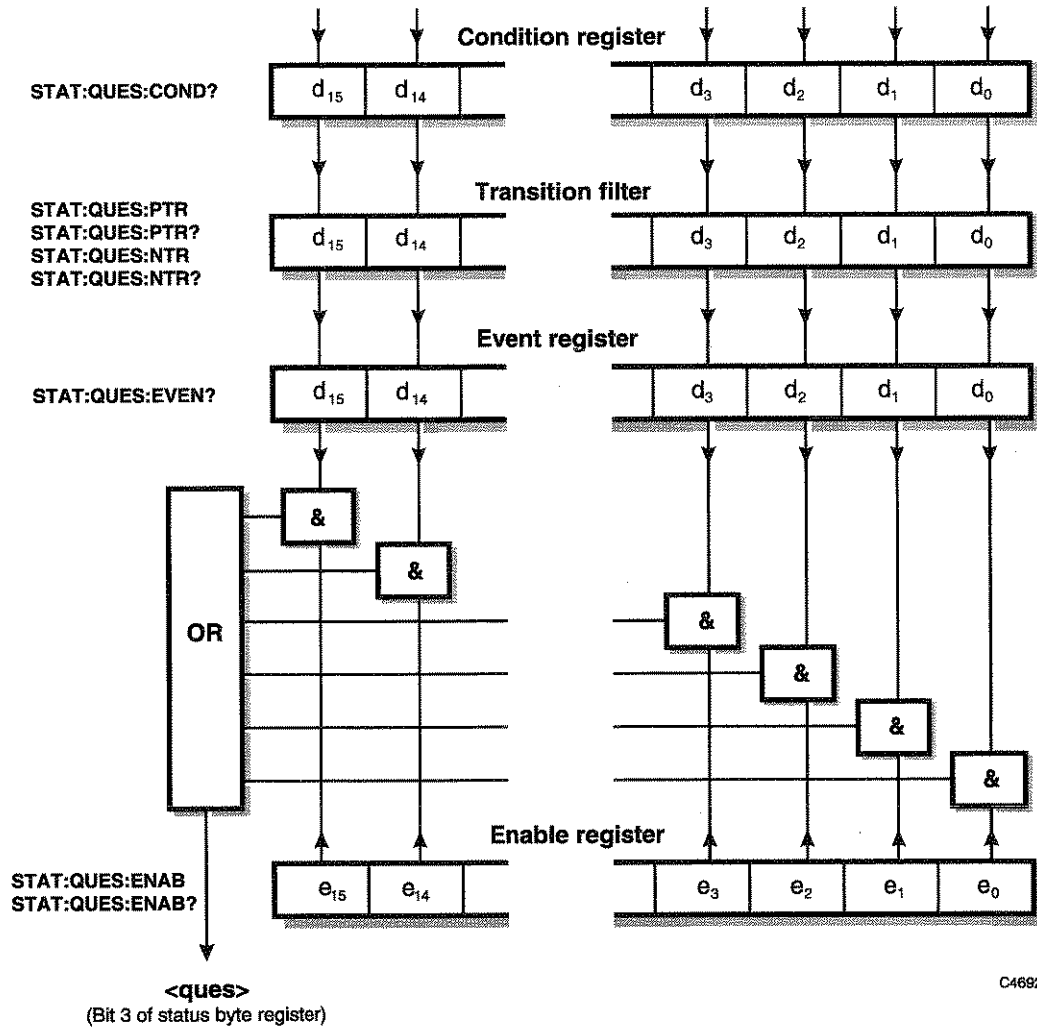

C4692

d0	-	d8	calibration required
d1	-	d9	oscillator
d2	-	d10	-
d3	power	d11	-
d4	-	d12	-
d5	frequency	d13	-
d6	-	d14	-
d7	-	d15	-

OPERation status register

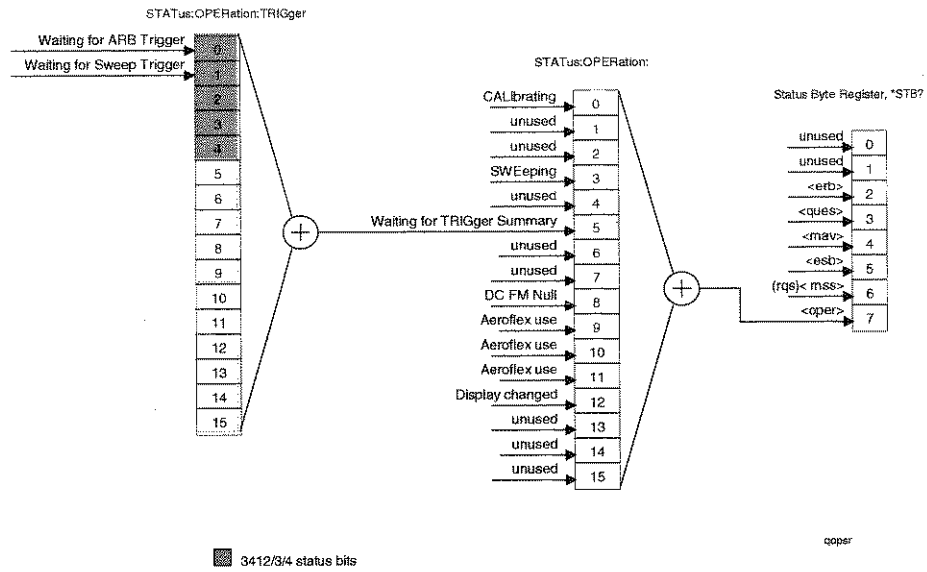

Questionable power status register

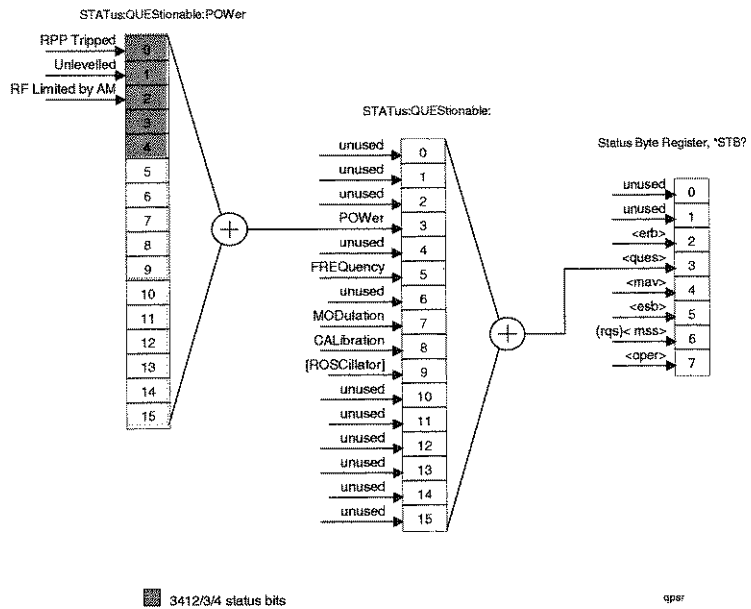

Questionable frequency status register

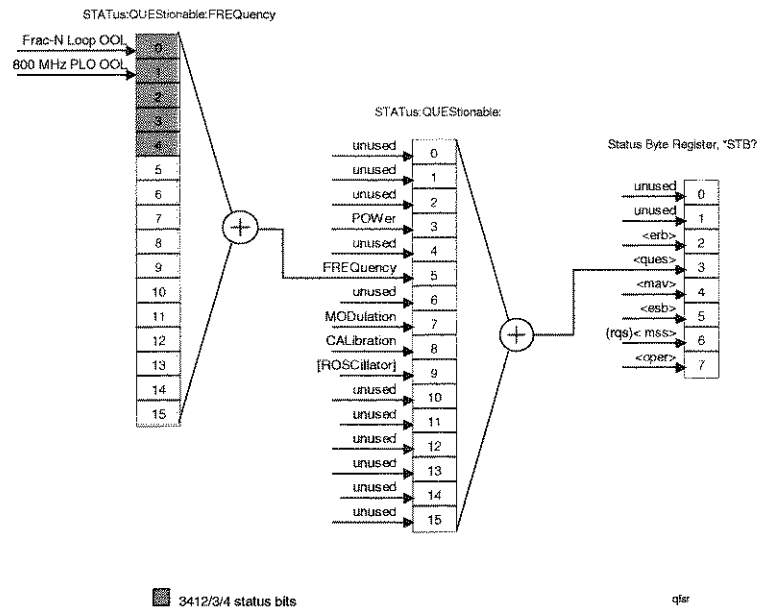

Questionable AM status register

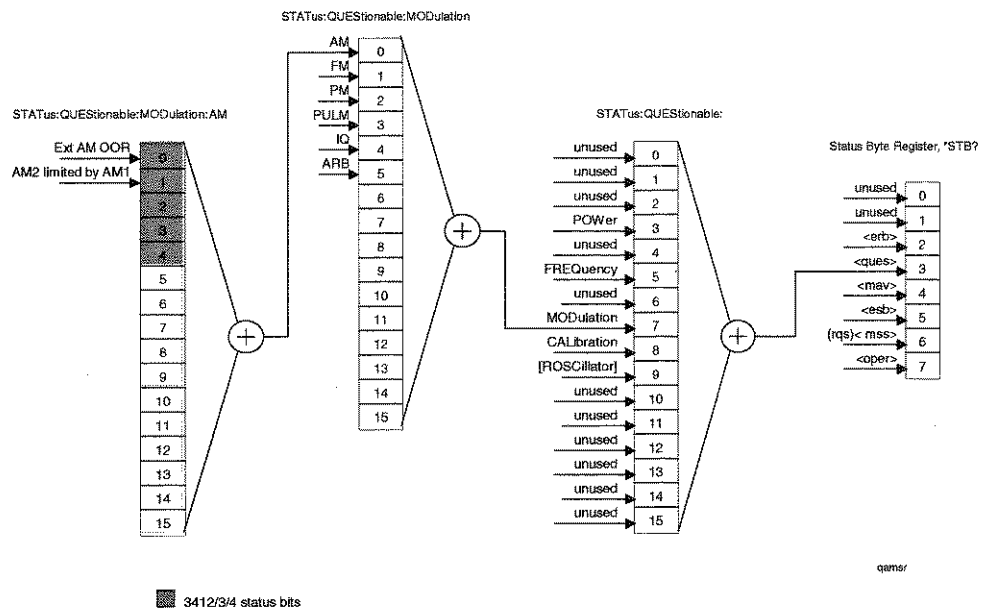

Questionable FM status register

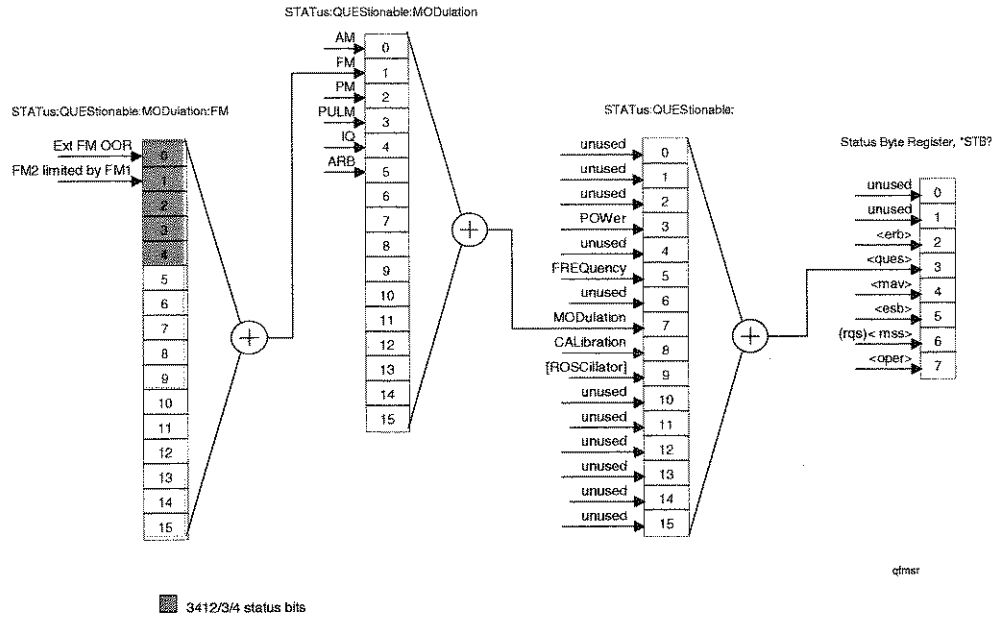

Questionable PM status register

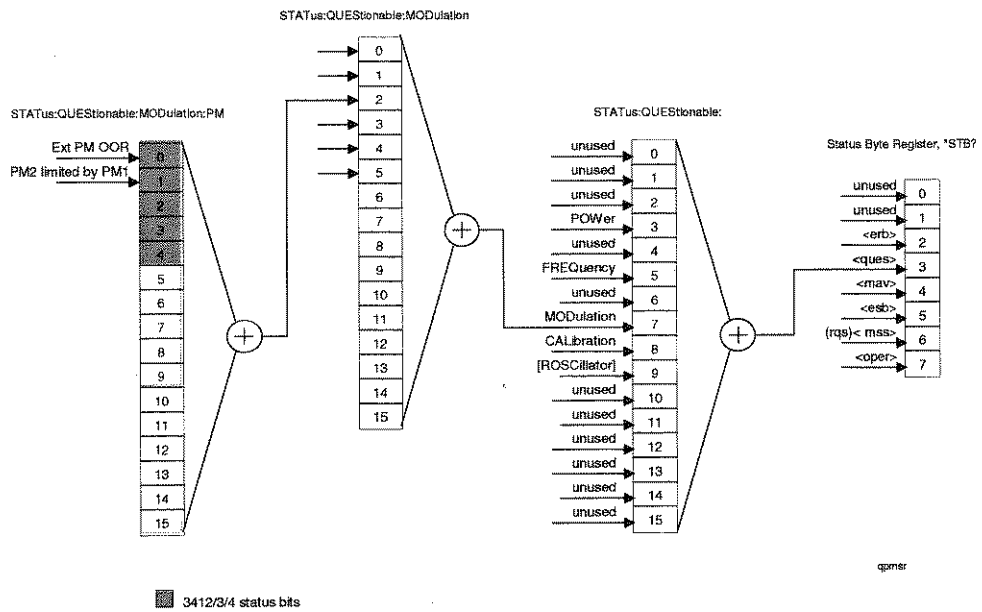

Questionable PULM status register

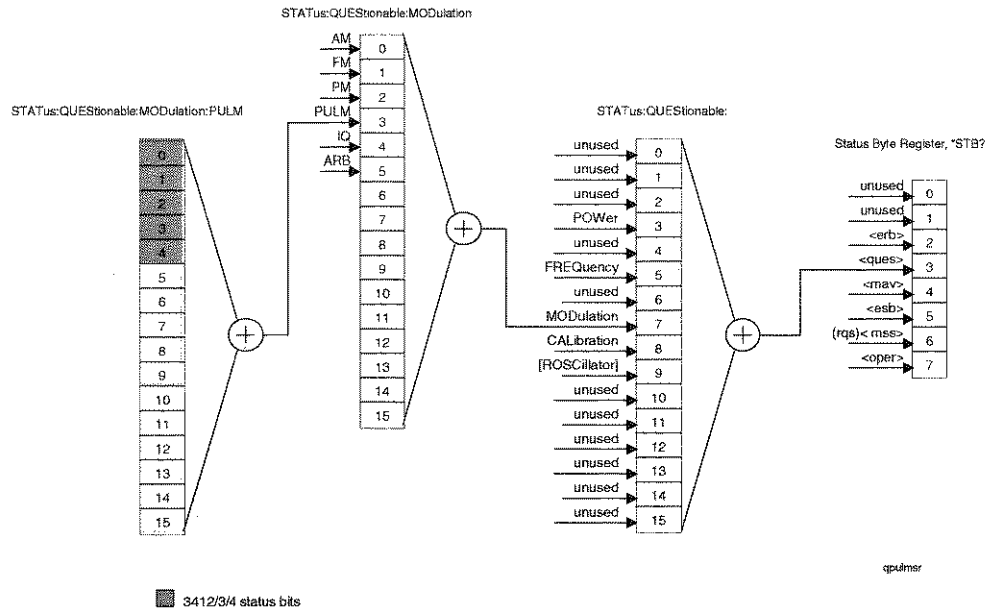

Questionable IQ status register

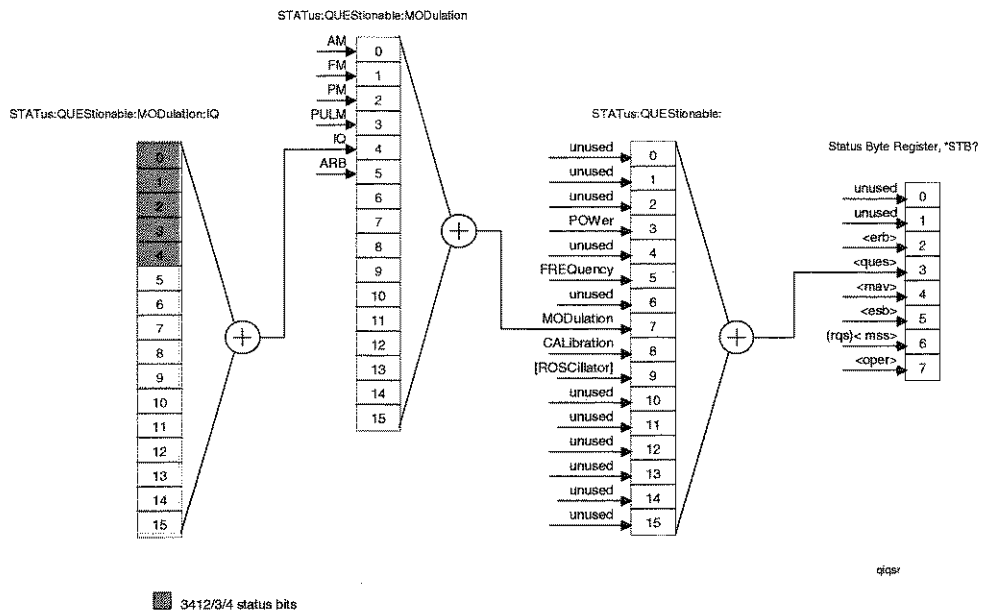

Questionable ARB status register

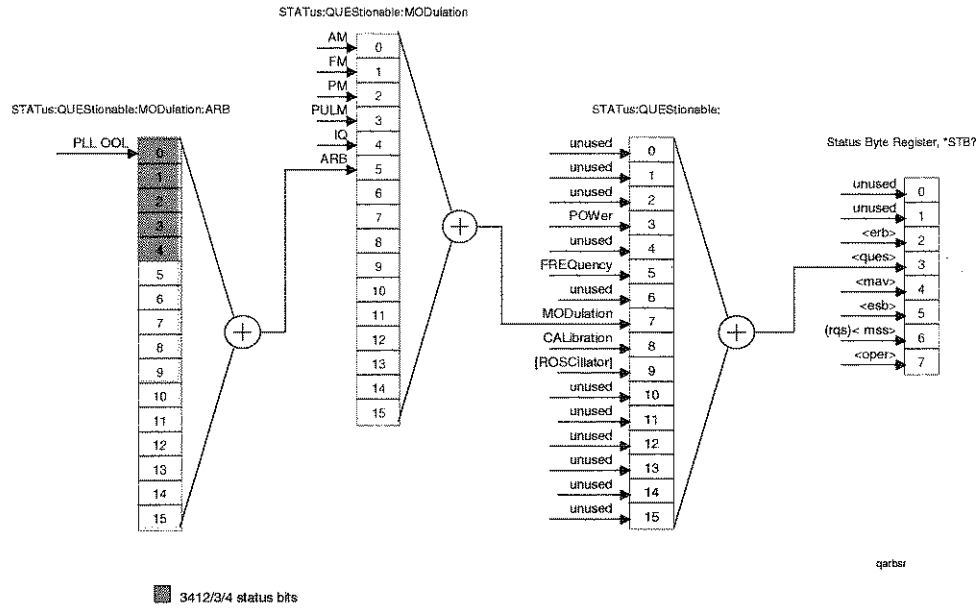

Questionable DM status register

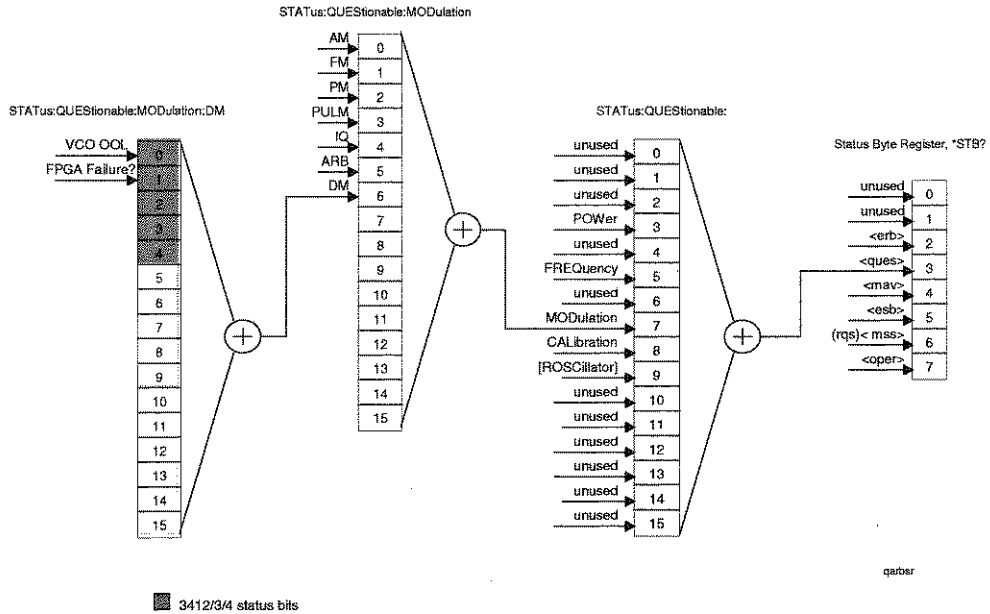

Questionable ROscillator status register

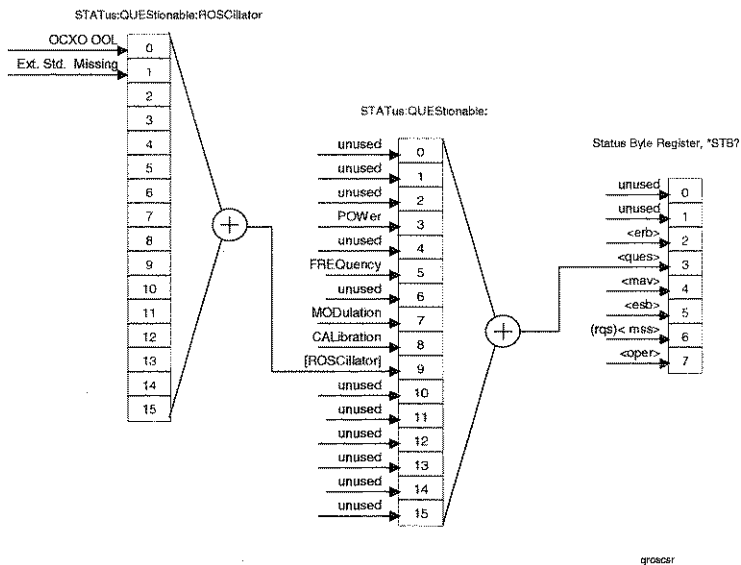

Questionable CALibration status register

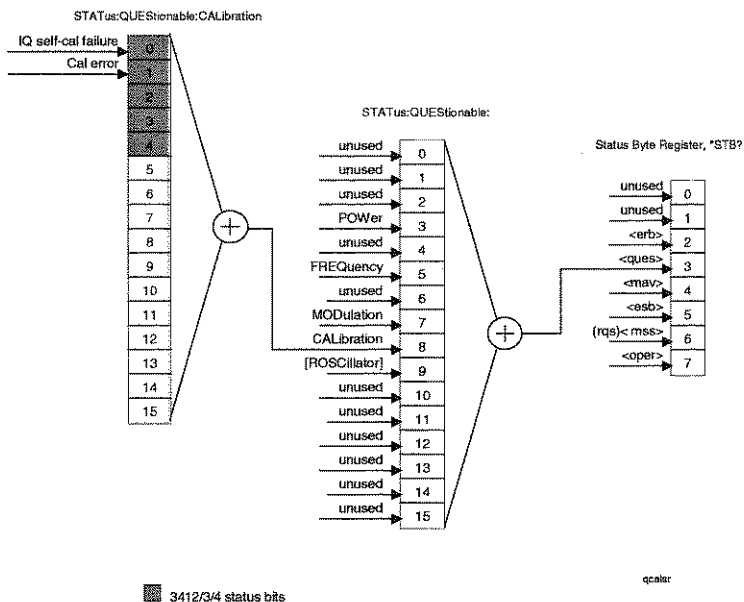

Chapter 5

BRIEF TECHNICAL DESCRIPTION

Contents

Introduction.....	5-2
RF board	5-2
Control board	5-3
Driver board.....	5-3
Attenuator	5-4
ARB board	5-4
Real-time baseband board	5-4
Differential IQ board.....	5-5
Frequency extension module.....	5-6

Introduction

The 3410 Series are portable synthesized signal generators covering the frequency ranges:

250 kHz–2.0 GHz	3412
250 kHz–3.0 GHz	3413
250 kHz–4.0 GHz	3414
250 kHz–6.0 GHz	3416

The carrier can be IQ, amplitude, frequency, phase or pulse modulated. An internal AF source generates simultaneous two-tone modulation.

An optional internal ARB (arbitrary waveform generator) generates a baseband IQ drive signal and can provide a variety of modulated carriers by loading suitable data files.

An RF level control system allows the output to be varied over a wide level range, ensuring that it is suitable for measuring both receiver sensitivity and overload. Attention to RF level accuracy in the output control system and attenuator minimizes uncertainty and maximizes repeatability in manufacturing. RF level is controlled by a mechanical or electronic attenuator and an ALC system.

Information is presented on a touch-screen LCD, from which all parameters can be entered. The instrument can also be controlled from its front-panel keyboard, and via GPIB or RS-232. The remote interfaces allow control of all functions except the supply switch, and so enable the instrument to form part of a fully automated production test system.

Fig. 5-1 shows a block diagram of the instrument.

Signal path

External or internally generated modulation from the control board is selected, routed and conditioned on the driver board. AM signals drive the IQ modulators directly, FM and PM signals modulate the carrier via the frequency synthesizer.

I and Q waveforms stored in the ARB in digital form are converted to analog signals before being routed via the driver board to the IQ modulators on the RF board.

The modulated carrier from the IQ modulators passes through switched filters, is amplified, conditioned and leveled before passing through the attenuator and to the RF output socket. A directional pick-off and detector arrangement senses the amount of power being generated and a feedback system corrects the amplitude of the signal being generated at the output.

An internal or externally-derived 1 or 10 MHz reference is used to ensure that all signals are derived from a common frequency reference.

RF board

The RF board generates a 0.25 to 4000 MHz RF signal. The signal can be modulated with high dynamic range, wide bandwidth AM, FM or IQ modulation.

The RF board is housed within an aluminum 'clamshell' box. It is connected to an attenuator and a driver board, where these three components become a plug-in RF module. The board connects to the driver board by two 40-way board-to-board connectors for power, signaling and serial bus. It requires a 10 MHz reference from the control board. The RF output connects to the attenuator via a semi-rigid cable. The attenuator (mechanical or electronic; both have reverse power protection) is bolted to the tray.

The fractional-N phase locked loop frequency synthesizer generates high-band octave signals using a harmonic generator and voltage-tuned filter. Analog FM/PM modulation is applied to the VCO. Frequency dividers and doublers provide outputs to the low/mid-band and doubler-band IQ modulators. The modulators receive AM and vector I and Q signals from the driver board.

The IQ switch routes the selected band to the various modulators. The ALC modulator controls the RF board's output power via feedback from the pick-off, which provides a voltage proportional to power from the detector output. The burst modulator can provide up to 80 dB attenuation in order to produce power profiles. The level modulator provides 1 dB steps in gain within a 6 dB attenuator step.

Mode switching provides 24 dB of RF level range in 3 dB steps when changing noise modes and carrier frequency.

The lowest frequency band (250 kHz to 375 MHz) is generated by the BFO mixer that combines IQ modulated 860 MHz with 860.25 to 1235 MHz. The BFO switch combines the BFO band with the RF output.

Communication to the RF board is via a four-wire serial bus. The registers on the board are used to drive the board directly, with the manipulation of the calibration data done on the control board. There is extensive self-check capability of the serial bus and RF board registers.

Control board

The control board connects directly to the driver board, delivering power, serial communications bus and two independent internal 50 kHz modulation sources. An optional ARB or real-time baseband board can be plugged into it.

The control board provides all the set-up and configuration control for the instrument and applies calibration corrections to the hardware settings and controls the output to the display. This board handles the GPIB, RS232 and other I/O ports. It also provides the internal frequency standard and all the selection and phase-locked loop circuitry required to lock the internal standard to a range of external reference frequencies. The internal frequency standard can be phase locked to an external 1 MHz or 10 MHz reference, or if the external reference is good enough it can be routed directly through to the RF tray to take advantage of its performance figures. The internal standard can be routed to a connector on the rear panel to allow other instruments to be phase-locked to it.

The bi-directional four-wire serial bus links the RF board, the attenuator driver board, the driver board, the frequency standard circuitry and the optional ARB/real-time baseband board.

The front panel interface drives the LCD with touch-screen and the keyboard matrix. An on/standby LED on the front panel indicates the state of the instrument; the LED is green when the instrument is on and changes to amber when in standby mode. The control knob produces two signals in quadrature with each other, which have to be decoded to determine the direction and amount of rotation.

A connection to the auxiliary connector on the rear panel of the instrument outputs marker bits from the ARB board (if fitted) and a burst control marker bit; and inputs a burst control input and an externally generated A/B level control signal.

Driver board

This unit, part of the RF tray, is mounted on the metalwork covering the back of the RF board. Two board-to-board connectors interconnect the driver and RF boards.

The driver board takes the conditioned detector voltage from the RF board and controls the output power via its ALC loop, which adjusts the ALC modulator on the RF board.

A modulation routing switch selects between various sources — signals from the internal modulation paths, modulation inputs, external or baseband I and Q inputs — and applies conditioning to the AM, FM and PM signals. AM and vector modulation signals are conditioned and have correction applied before transmission to the IQ modulators on the RF board.

For FM, signal amplitude controls the FM deviation, while for phase modulation, the signal passes through a differentiator circuit. FM low-frequency components are passed to the fractional-N divider on the RF board, where they are incorporated into the frequency synthesis process. The full bandwidth FM signal also passes (after programmable attenuation) directly to the VCO on the RF board.

The driver board provides serial bus buffering for the RF board and the attenuators, power supply filtering for the RF board, and sources for IQ and FM calibration.

Attenuator

The attenuator provides reverse power protection both when powered up and powered down. When an electronic attenuator is fitted, it is also used to implement pulse modulation.

ARB board

This optional board is mounted on the top of the control board. A single board-to-board connector passes the power and control signals. Three coaxial leads provide reference frequency and output signal connections.

The ARB board is an arbitrary waveform IQ signal source generator. It generates signals from samples stored in non-volatile memory. Three digital signals (marker bits) may be stored with the samples, and these are processed to maintain their time relationship to the output waveforms. They are used as event triggers, for example during burst modulation.

The ARB consists of a variable frequency clock generator (synthesizer), flash memory for storing waveform samples, three FPGAs containing between them sample interleaving circuitry and digital interpolation filters; DACs, and analog filters.

The synthesizer and output offset control circuitry is controlled by the serial bus from the control board. A frequency reference is supplied from the control board's frequency standard.

The waveform circuitry is controlled using a single parallel port on the CPU on the control board. The contents of the FPGAs are held in a flash memory, which can be updated via the parallel port. A CPLD is used to transfer the contents of the flash memory into the FPGAs when the board is powered up. The CPLD is programmed using boundary scan.

The analog waveform outputs are routed to the driver board. Marker bits are routed via the power and control connector to the control board.

The ARB board may also be reconfigured (via the serial bus) as a general purpose two-channel function generator, for providing high frequency modulation signals.

Real-time baseband board

The RTBB board generates 0 to 20 MHz bandwidth I and Q analog outputs. These outputs are fed to the IQ modulator within the instrument, to be modulated onto the RF carrier.

The RTBB board is fitted in the same position as the ARB board. The boards are exactly the same size and shape and are interchangeable, and both are mounted to the control board in the same way.

Host interface

The host interface is used to configure the FPGA that generates the real-time modulation and interfaces to the rest of the RTBB board, and to provide control of the FPGA and calibration store.

The calibration store contains DC offsets, gain values and information about the board.

The 40-way connector also provides three marker lines and an external sync line. The marker lines are outputs and the external sync line is an input. The marker lines can be used to indicate specific positions in a modulated signal, for instance, the start of a new frame. Markers 1 and 2 are also fed to the RF section where Marker 1 can be used for RF burst control and Marker 2 for RF level switching.

Field programmable gate array (FPGA)

The FPGA performs real-time modulation and interfacing to hardware on the RTBB board.

Modulation

The FPGA converts source data into modulated I and Q data which is fed to the I and Q DACs. Source data can be generated within the FPGA, can enter the LVDS interface from an external instrument, or can be stored inside the FPGA's external memory. The FPGA then modulates it to form I and Q digital data. Different configurations are loaded for different modulation schemes. Once modulated, the data streams are then filtered before being fed to the DACs.

Interfacing

The FPGA provides two DSP interfaces so that data can be fed to the DSPs for additional processing and then read back and fed back into the modulation path. One DSP is dedicated to each I and Q channel.

An external memory interface is provided to allow the control board to store source data into the external FPGA memory, which can then be read back and used as source data to the modulation section.

An LVDS interface allows data to be written to/read from the LVDS drivers and receivers.

DACs and filters

The DACs and filters are the final stage in the modulation process. 14-bit I and Q data is fed out of the FPGA and into each of the two DACs. The DACs run off the VCO clock, which is controlled by fractional-N circuitry inside the FPGA.

A four-channel DAC, controlled by the FPGA, is used to provide I and Q DAC reference voltages, as well as a DC offset voltage for each channel.

The outputs from the I and Q DACs are filtered to remove the sampling clock and extra images that are generated by the sampling process.

The I and Q outputs are then fed into a gain section that provides an overall gain adjustment of 0 to 15 dB in 1 dB steps.

The final I and Q outputs are then fed to the IQ modulator via coaxes connected to the two MMCX sockets provided on the board.

Differential IQ board

Monitor output I and Q signals are passed to the differential IQ board from the driver board. The differential IQ board converts the I and Q signals to differential pairs, using DACs to provide adjustment for differential offset and overall bias, and a calibration circuit to zero differential offset and bias settings. The differential outputs are then routed to the instrument's rear panel.

Frequency extension module

The frequency extension module, used in 3416, generates signals from 4 to 6 GHz by doubling a 2 to 3 GHz signal from the RF board. Power and control are derived from the driver board.

The frequency extension module consists of a microwave board and a bias board.

For frequencies less than and including 4 GHz, the RF tray operates as normal. RF tray output is routed to the attenuator via an electronic switch on the microwave board.

For frequencies above 4 GHz, the RF tray functions as a 2 to 3 GHz synthesizer with optional frequency modulation. The LO is taken from a separate output. The microwave board doubles the LO signal, applies IQ modulation, then amplifies the signal to the required level and applies appropriate level control. The RF signal is then routed to the attenuator as normal.

Level control above 4 GHz is accomplished using the leveling loop circuitry on the driver board. The microwave board ALC modulator and detector are switched electronically in place of those on the RF tray, using analog switches on the driver board. Similarly, the microwave board burst modulator is switched in. The detector law correction circuit is on the bias board.

IQ calibration is carried out in a similar manner to that below 6 GHz, using circuitry on the driver board. The IQ calibration signal is derived from a limited version of the output level detector voltage. This is different to below 4 GHz, where a dedicated IQ cal detector is provided. The IQ drive signals are taken from the output of the driver board IQ conditioning circuit and applied to the IQ modulator in the frequency extension module.

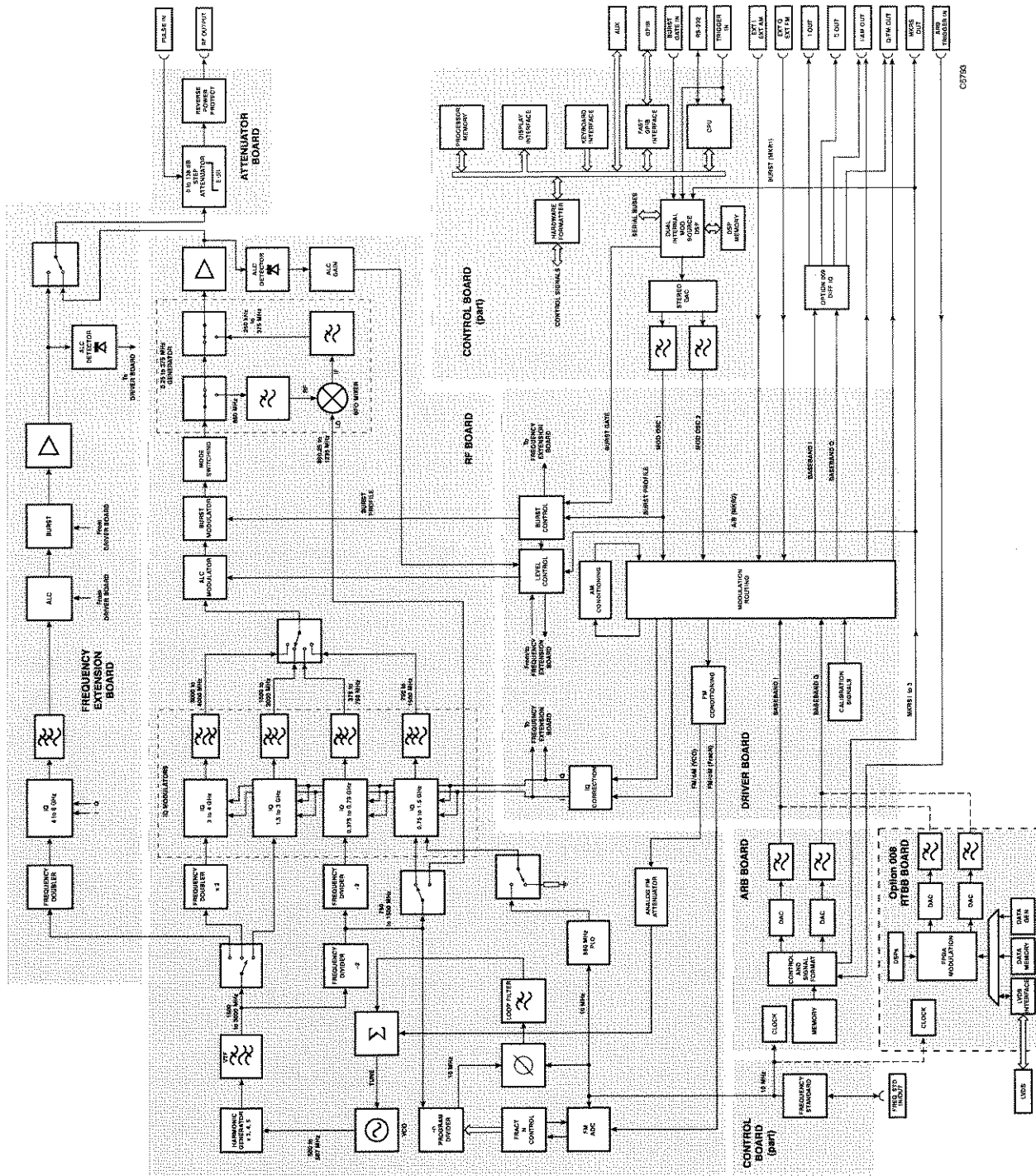

Fig. 5-1 Block diagram, 3416

1

2

3

4

Chapter 6

OPERATIONAL VERIFICATION TESTING

Contents

Introduction.....	6-2
Recommended test equipment.....	6-2
Test precautions	6-2
Test procedures	6-3
Checking that the instrument powers up correctly	6-3
Carrier frequency test.....	6-4
RF output level tests.....	6-5
RF level control test	6-5
RF level attenuation test.....	6-9
Analog modulation tests.....	6-10
Frequency modulation test	6-10
Amplitude modulation test	6-11
Digital modulation tests	6-13
External IQ inputs	6-13
Real-time baseband (instruments fitted with Option 008).....	6-15
Baseband tones and IQ modulator performance.....	6-15
Baseband phase generation tests	6-19
Baseband frequency generation tests.....	6-21
Differential IQ outputs (instruments fitted with Option 009).....	6-23
Bias voltage accuracy.....	6-23
Differential offset voltage accuracy	6-24
Signal amplitude accuracy.....	6-24

Introduction

The test procedures in this chapter enable you to verify that the signal generator is operating correctly, in the shortest possible time, using a minimum of test equipment, and with reasonable confidence. These tests are suitable for use as a goods inwards inspection or for a quick verification of performance after repair.

Recommended test equipment

Recommended test equipment is shown below. Alternative equipment may be used provided it complies with the stated minimum specification. The minimum specification is only an indication of the required performance. With all measurements, you should ensure that the performance of the test equipment has adequate stand-off from the specification of the unit under test (UUT).

Description	Minimum specification	Example	Test parameters
Power meter and sensor	250 kHz to 6 GHz	IFR 6960B and 6910	RF level accuracy
Modulation meter	AM/FM measurement	IFR 2305	Analog modulation measurement
Signal generator	Up to 50 MHz, 500 mV	IFR 2023A or 2030	IQ modulator response
Spectrum analyzer	6 GHz	IFR 2394	IQ modulator response
Frequency counter	6 GHz	Agilent 53181A with option 124	Frequency accuracy
Digital multimeter	DC voltage measurement AC voltage measurement at 100 kHz	Agilent 33401	IQ outputs

Test precautions

To ensure minimum errors and uncertainties when making measurements, it is important to observe the following precautions:



- 1 Always use recently calibrated test equipment, with any correction figures taken into account, so as to establish a known traceable limit of performance uncertainty. This uncertainty must be allowed for in determining the accuracy of measurements.
- 2 Ensure any user calibration routines are performed when necessary. On most power meters it is also necessary to perform an auto-zero routine.
- 3 Use the shortest possible connecting leads.
- 4 Allow 20 minutes for the UUT to warm up, plus any extra time for other test equipment being used.

Test procedures

Each test procedure shows you how to configure the test equipment, followed by a description of how to perform the test, with tables for recording your results. Maximum and minimum limits that all measurements should fall within are indicated, provided that the recommended test equipment has been used and the precautions above adhered to.

If any measurements fall outside the limits, this could indicate a faulty instrument or a problem with the configuration or settings of the test equipment.

Each test procedure relies on the UUT being set to its power-on conditions. To avoid switching the instrument off and back on, reset the UUT by selecting:

 ■ System 4 <Preset>  ENTER

Checking that the instrument powers up correctly

This test ensures that the signal generator powers up in a satisfactory manner and that the internal self-tests do not report any errors.

- Check that no external signal sources are connected.
- Switch on the power on/off switch on the rear panel.
This supplies power to the instrument, which is now in standby mode (the LED on the front panel lights up amber).
- Press the supply switch on the front panel until the LED lights up green and the instrument powers up.

The instrument displays a welcome screen, followed by a screen of instrument details (instrument and software version), a self-test, and then the main SIG GEN screen.

- Ensure that no error messages are displayed.

Carrier frequency test

This test checks the signal generator's frequency locking circuitry. It will confirm correct operation of phase locked loops and dividers. Overall accuracy is determined by the instrument's internal reference standard. By using the UUT's reference output as the reference frequency for the frequency counter, the test limits are ± 1 count.

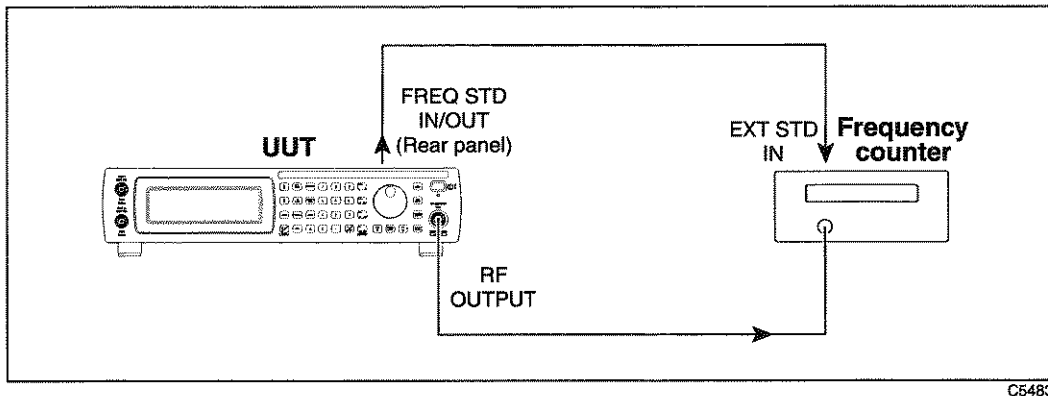

Fig. 6-1 Carrier frequency accuracy test set-up

- 1 Connect the test equipment as shown in Fig. 6-1.
- 2 On the UUT set:

250 [kHz]
 10 [dB]
 ■ System 2 <Int Ref>

- 3 Record the frequency measured by the counter against each of the carrier frequencies shown in Table 6-1.

Table 6-1 Carrier frequency results

Carrier frequency	Minimum (Hz)	Result (Hz)	Maximum (Hz)
250 kHz	249 999		250 001
1 MHz	999 999		1 000 001
10 MHz	9 999 999		10 000 001
50 MHz	49 999 999		50 000 001
100 MHz	99 999 999		100 000 001
375 MHz	374 999 999		375 000 001
750 MHz	749 999 999		750 000 001
1000 MHz	999 999 999		1 000 000 001
1500 MHz	1 499 999 999		1 501 000 001
2000 MHz	1 999 999 999		2 000 000 001
3413 and 3414			
3000 MHz	2 999 999 999		3 000 000 001
3414 only			
4000 MHz	3 999 999 999		4 000 000 001

RF output level tests

The RF level control test ensures correct operation of the signal generator's level control circuitry.

The output attenuation test uses the instrument's built-in diagnostic utility to insert each attenuator pad in turn. This ensures that the pads are enabled correctly and that the pad values are nominally correct. The values are nominal values because no software correction figures are applied, as would be the case during normal operation.

Both tests are performed using only a power meter.

RF level control test

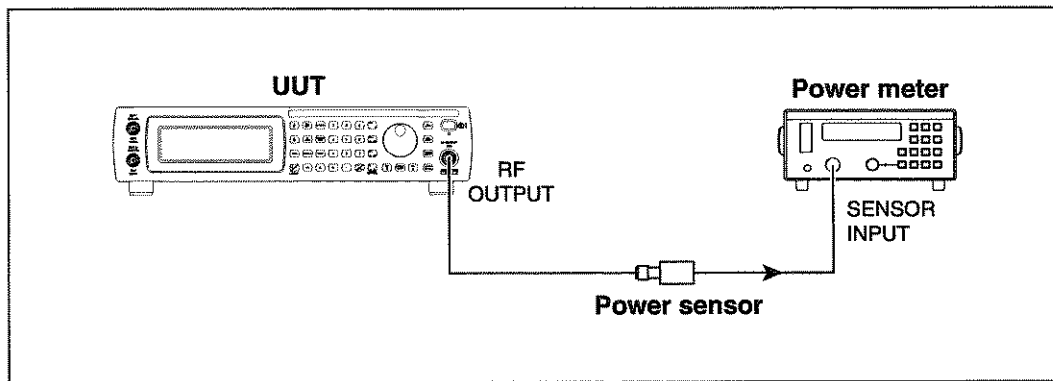

C5484

Fig. 6-2 RF output level test setup

- 1 Connect the test equipment as shown in Fig. 6-2.
- 2 On the UUT set:

Freq 250 [kHz]
 Lev 13 [dB]
 RF ON/OFF

- 3 Record the output level measured by the power meter against each of the carrier frequencies and RF levels shown in Table 6-2, checking that the results are within the indicated limits.

Table 6-2 RF output level results

Carrier frequency	RF level	Minimum (dBm)	Result (dBm)	Maximum (dBm)	Exclusions
11 MHz	+19 dBm	+18.5		+19.5	Not Option 003
	+16 dBm	+15.5		+16.5	
	+7 dBm	+6.5		+7.5	
	0 dBm	-0.5		+0.5	
	-4 dBm	-4.5		-3.5	Not Option 001
	-10 dBm	-10.5		-9.5	Not Option 001
137.5 MHz	+19 dBm	+18.5		+19.5	Not Option 003
	+16 dBm	+15.5		+16.5	
	+7 dBm	+6.5		+7.5	
	0 dBm	-0.5		+0.5	
	-4 dBm	-4.5		-3.5	Not Option 001
	-10 dBm	-10.5		-9.5	Not Option 001
237.5 MHz	+19 dBm	+18.5		+19.5	Not Option 003
	+16 dBm	+15.5		+16.5	
	+7 dBm	+6.5		+7.5	
	0 dBm	-0.5		+0.5	
	-4 dBm	-4.5		-3.5	Not Option 001
	-10 dBm	-10.5		-9.5	Not Option 001
562.5 MHz	+19 dBm	+18.5		+19.5	Not Option 003
	+16 dBm	+15.5		+16.5	
	+7 dBm	+6.5		+7.5	
	0 dBm	-0.5		+0.5	
	-4 dBm	-4.5		-3.5	Not Option 001
	-10 dBm	-10.5		-9.5	Not Option 001
1012.5 MHz	+19 dBm	+18.5		+19.5	Not Option 003
	+16 dBm	+15.5		+16.5	
	+7 dBm	+6.5		+7.5	
	0 dBm	-0.5		+0.5	
	-4 dBm	-4.5		-3.5	Not Option 001
	-10 dBm	-10.5		-9.5	Not Option 001
1537.5 MHz	+19 dBm	+18.5		+19.5	Not Option 003
	+16 dBm	+15.5		+16.5	
	+7 dBm	+6.5		+7.5	
	0 dBm	-0.5		+0.5	
	-4 dBm	-4.5		-3.5	Not Option 001
	-10 dBm	-10.5		-9.5	Not Option 001
2000 MHz	+19 dBm	+18.5		+19.5	Not Option 003
	+16 dBm	+15.5		+16.5	
	+7 dBm	+6.5		+7.5	
	0 dBm	-0.5		+0.5	
	-4 dBm	-4.5		-3.5	Not Option 001
	-10 dBm	-10.5		-9.5	Not Option 001

OPERATIONAL VERIFICATION TESTING

Carrier frequency	RF level	Minimum (dBm)	Result (dBm)	Maximum (dBm)	Exclusions
3413, 3414 and 3416					
2001 MHz	+19 dBm	+18.25		+19.75	Not Option 003
	+16 dBm	+15.25		+16.75	
	+7 dBm	+6.25		+7.75	
	0 dBm	-0.75		+0.75	
	-4 dBm	-4.75		-3.25	Not Option 001
	-10 dBm	-10.75		-9.25	Not Option 001
2512.5 MHz	+19 dBm	+18.25		+19.75	Not Option 003
	+16 dBm	+15.25		+16.75	
	+7 dBm	+6.25		+7.75	
	0 dBm	-0.75		+0.75	
	-4 dBm	-4.75		-3.25	Not Option 001
	-10 dBm	-10.75		-9.25	Not Option 001
3000 MHz	+19 dBm	+18.25		+19.75	Not Option 003
	+16 dBm	+15.25		+16.75	
	+7 dBm	+6.25		+7.75	
	0 dBm	-0.75		+0.75	
	-4 dBm	-4.75		-3.25	Not Option 001
	-10 dBm	-10.75		-9.25	Not Option 001
3414 and 3416					
3001 MHz	+13 dBm	+12		+14	
	+7 dBm	+6		+8	
	0 dBm	-1		+1	
	-4 dBm	-5		-3	Not Option 001
	-10 dBm	-11		-9	Not Option 001
3750 MHz	+13 dBm	+12		+14	
	+7 dBm	+6		+8	
	0 dBm	-1		+1	
	-4 dBm	-5		-3	Not Option 001
	-10 dBm	-11		-9	Not Option 001
4000 MHz	+10 dBm	+9		+11	
	+7 dBm	+6		+8	
	0 dBm	-1		+1	
	-4 dBm	-5		-3	Not Option 001
	-10 dBm	-11		-9	Not Option 001

Carrier frequency	RF level	Minimum (dBm)	Result (dBm)	Maximum (dBm)	Exclusions
3416 only					
4001 MHz	+8 dBm	+7		+9	
	+4 dBm	+3		+5	
	0 dBm	-1		+1	
	-4 dBm	-5		-3	Not Option 001
	-10 dBm	-11		-9	Not Option 001
5025 MHz	+8 dBm	+7		+9	
	+4 dBm	+3		+5	
	0 dBm	-1		+1	
	-4 dBm	-5		-3	Not Option 001
	-10 dBm	-11		-9	Not Option 001
6000 MHz	+8 dBm	+7		+9	
	+4 dBm	+3		+5	
	0 dBm	-1		+1	
	-4 dBm	-5		-3	Not Option 001
	-10 dBm	-11		-9	Not Option 001

RF level attenuation test

1 On the UUT set:

Freq 250 [kHz]

Lev 8 [dB]

RF
ON/OFF

2 Set a reference on the power meter.

3 On the UUT select:

UTIL ■ *Diagnostics* 4 <0-3>

4 The UUT displays the first four attenuator pads with pad 0 highlighted. The pad may be inserted and removed by pressing **1** and **0** respectively. To select pads 1, 2 or 3 press **↕** or **↕** as required.

To select the remaining three pads, touch <4-6> and repeat as above as required.

5 Using Table 6-3, record the change in output level measured by the power meter against each of the carrier frequencies for each of the attenuator pads. Ensure that the previous pad has been removed before inserting the next.

Table 6-3 Attenuator pad results

Attenuator pad	Carrier frequency		
	250 kHz	1500 MHz	Maximum frequency
Pad 0 6 dB			
Pad 1 30 dB			
Pad 2 30 dB			
Pad 3 6 dB			
Pad 4 24 dB			
Pad 5 12 dB			
Pad 6 30 dB			

Analog modulation tests

Frequency modulation test

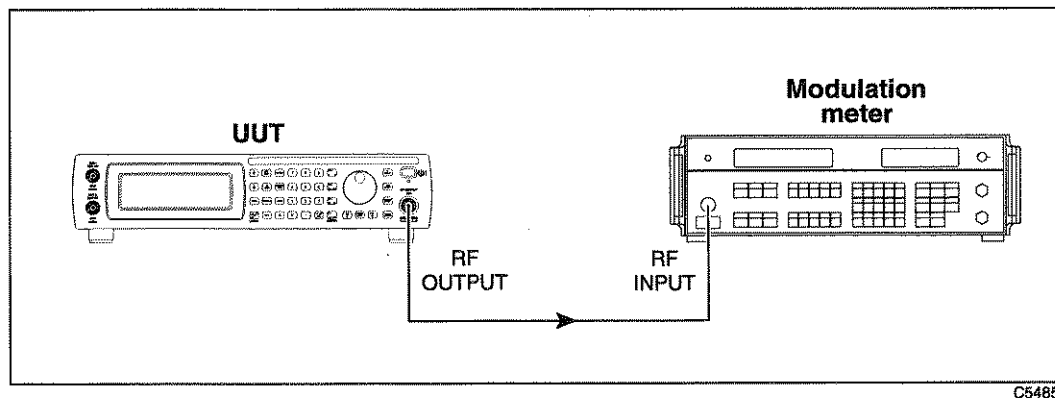

C5485

Fig. 6-3 Analog modulation test setup

- 1 Connect the test equipment as shown in Fig. 6-3.
- 2 On the UUT set:

Freq 375 [MHz]
 Lev 0 [dB]
 ANALOG MOD <FM> Int FM1 SIG GEN FM1 100 [kHz]
 RF ON/OFF

- 3 On the modulation meter select the FM, 50 Hz–15 kHz filter, Pk-Pk/2.
- 4 Record the deviation measured by the modulation meter against each of the carrier frequencies and deviations shown in Table 6-4, checking that the results are within the indicated limits.

Table 6-4 Frequency modulation results

Carrier frequency	Deviation	Minimum (kHz)	Result (kHz)	Maximum (kHz)
375 MHz	100 kHz	96		104
387.5 MHz	100 kHz	96		104
400 MHz	100 kHz	96		104
412.5 MHz	100 kHz	96		104
425 MHz	100 kHz	96		104
437.5 MHz	100 kHz	96		104
450 MHz	100 kHz	96		104
462.5 MHz	100 kHz	96		104
475 MHz	100 kHz	96		104
487.5 MHz	100 kHz	96		104
500 MHz	500 kHz	480		520
500 MHz	200 kHz	192		208
500 MHz	100 kHz	96		104
500 MHz	50 kHz	48		52
500 MHz	20 kHz	19.2		20.8
500 MHz	10 kHz	9.6		10.4

Amplitude modulation test

- 1 Connect the test equipment as shown in Fig. 6-3.
- 2 On the UUT set:

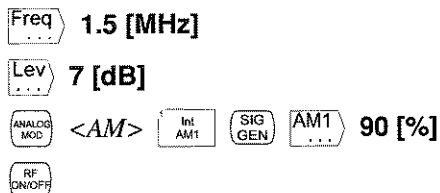

- 3 On the modulation meter select the AM, 50 Hz–15 kHz filter, Pk-Pk/2.
- 4 Record the deviation measured by the modulation meter against each of the carrier frequencies and depths shown in Table 6-5, checking that the results are within the indicated limits.

Table 6-5 Amplitude modulation results

Carrier frequency	Depth	Minimum (%)	Result (%)	Maximum (%)
1.5 MHz	80%	75.8		84.2
	30%	27.8		32.2
5 MHz	80%	75.8		84.2
	30%	27.8		32.2
10 MHz	80%	75.8		84.2
	30%	27.8		32.2
50 MHz	80%	75.8		84.2
	30%	27.8		32.2
100 MHz	80%	75.8		84.2
	70%	66.2		73.8
	60%	56.6		63.4
	50%	47		53
	40%	37.4		42.6
	30%	27.8		32.2
	20%	18.2		21.8
500 MHz	10%	8.6		11.4
	5%	3.8		6.2
	80%	75.8		84.2
	30%	27.8		32.2
	80%	75.8		84.2
1000 MHz	80%	75.8		84.2
	30%	27.8		32.2
1500 MHz	80%	75.8		84.2
	30%	27.8		32.2
2000 MHz	80%	75.8		84.2
	30%	27.8		32.2

Digital modulation tests

External IQ inputs

The digital modulation test ensures functionality of each of the IQ modulators.

A signal generator is used to stimulate the I and Q inputs in turn. The IQ modulator response is viewed on a spectrum analyzer.

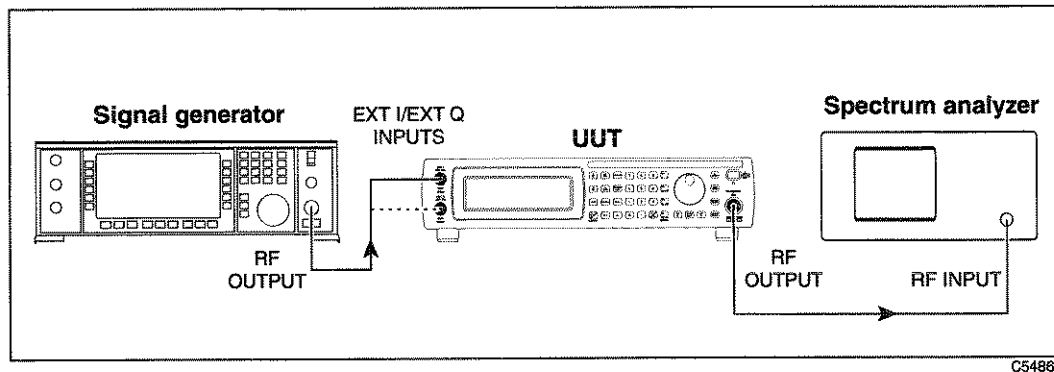

Fig. 6-4 RF output level test setup

- 1 Connect the test equipment as shown in Fig. 6-4.
- 2 On the UUT set:

375 [MHz]
 0 [dB]
 RF ON/OFF
 IQ MOD 1 Ext IQ

- 3 On the UUT set:

SIG GEN IQ <Self-Cal>
 Start Cal

Ensure that the IQ cal has successfully completed.

- 4 Set the signal generator to carrier frequency 500 kHz, RF output level 500 mV.
- 5 Set the spectrum analyzer to center frequency 375 MHz, span 22 MHz, ref level 0 dB, 1 dB/div, and set the trace to max hold.
- 6 Using the rotary control, tune the signal generator's carrier frequency up to 10 MHz in 10 kHz steps and view the sideband responses on the spectrum analyzer.
- 7 Using the marker facility on the spectrum analyzer, check the response of the upper and lower sidebands at 5 MHz and 10 MHz offsets, relative to the ± 500 kHz offset level.
- 8 Repeat 3 to 7 for remaining carrier frequencies in Table 6-6.
- 9 Connect the signal generator's output to the EXT Q input of the UUT and repeat 2 to 8 above.

Table 6-6 IQ modulator bandwidth results

Carrier frequency	Offset	Lower sideband	Maximum error	Upper sideband
375 MHz	5 MHz		-0.5 dB	
	10 MHz		-1 dB	
750 MHz	5 MHz		-0.5 dB	
	10 MHz		-1 dB	
1500 MHz	5 MHz		-0.5 dB	
	10 MHz		-1 dB	
2 GHz	5 MHz		-0.5 dB	
	10 MHz		-1 dB	
3 GHz	5 MHz		-0.5 dB	
	10 MHz		-1 dB	
4 GHz	5 MHz		-0.5 dB	
	10 MHz		-1 dB	
5 GHz	5 MHz		-0.5 dB	
	10 MHz		-1 dB	
6 GHz	5 MHz		-0.5 dB	
	10 MHz		-1 dB	

Real-time baseband (instruments fitted with Option 008)

Three tests are performed to ensure functionality of the real-time baseband option:

- Internally generated tones are used to test the performance of the IQ modulator and the tone generation circuitry. Carrier leak, intermodulation distortion and image suppression are measured to establish a high degree of confidence in the performance of the IQ modulator and associated RF circuitry.
- A QPSK signal is used to test the functionality of the baseband phase generation hardware.
- A GSM signal is used to test the functionality of the baseband frequency generation hardware.

In the following tests, LSB = lower sideband and USB = upper sideband.

Baseband tones and IQ modulator performance

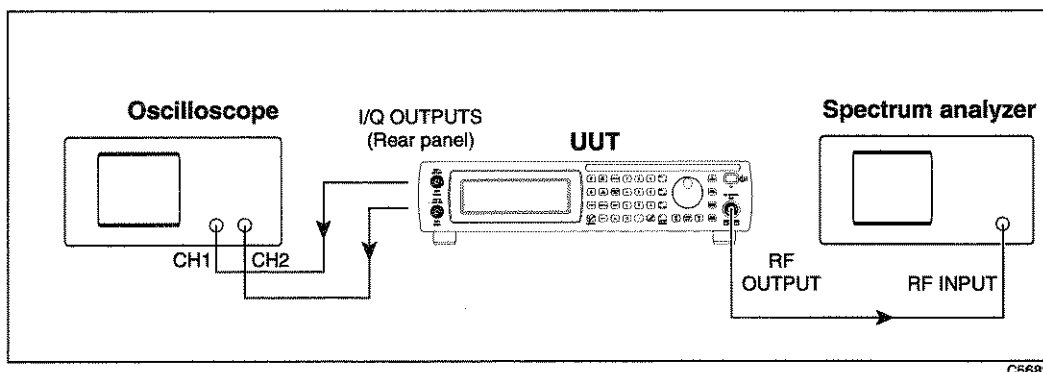

C5682

Fig. 6-5 Real time baseband test setup

- 1 Connect the test equipment as shown in Fig. 6-5.
- 2 On the UUT set:

2 [GHz]
 0 [dB]

 (wait five seconds for the application to download)

- 3 To configure the UUT to test intermodulation performance:

TONES (wait five seconds for the application to download)
 <Tone A> ■ State **ON** ■ Freq **10 [kHz]**
 <Tone B> ■ State **ON** ■ Freq **-10 [kHz]**

- 4 On the UUT set:

<Self-Cal>

Ensure that the IQ cal has successfully completed.

- 5 Set the spectrum analyzer to center frequency 2 GHz, span 100 kHz, resolution bandwidth 300 Hz. The trace should appear as shown in Fig. 6-6.

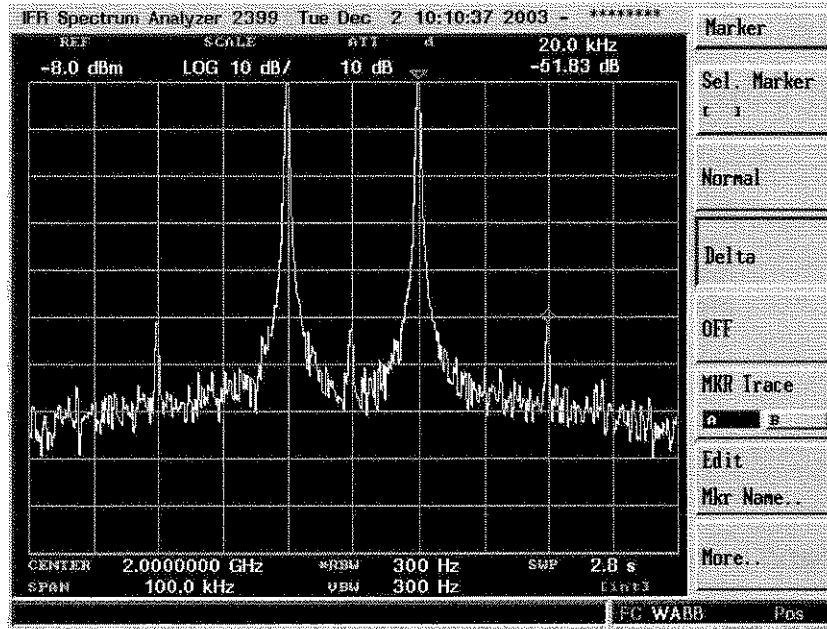
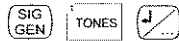

Fig. 6-6 Spectrum analyzer display showing intermodulation products

- 6 Using the Marker Delta facility, measure the level of the intermodulation products relative to the carrier sidebands.
- 7 To configure the UUT to test carrier leak and LSB image suppression:



<Tone B> ■ State OFF

- 8 The trace on the spectrum analyzer should appear as shown in Fig. 6-7.

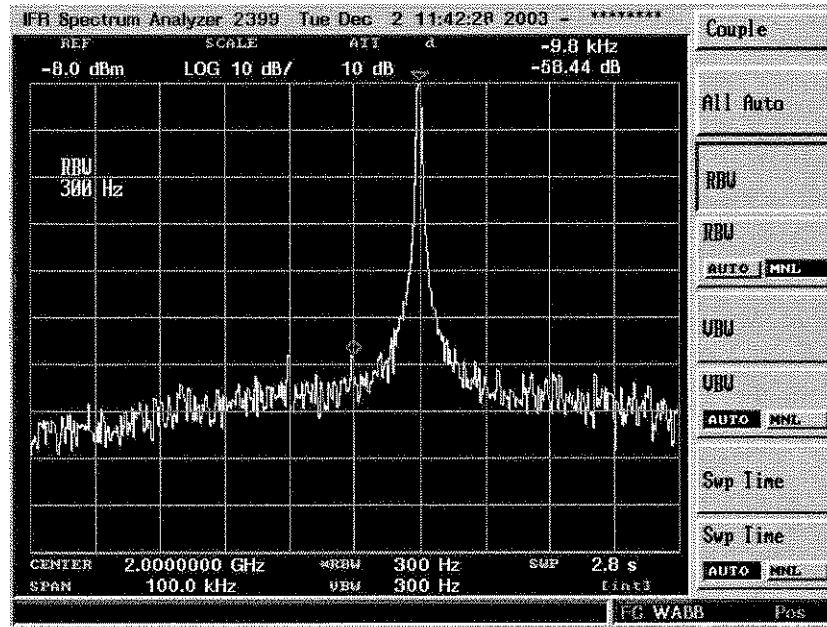

Fig. 6-7 Spectrum analyzer display showing carrier leakage measurement

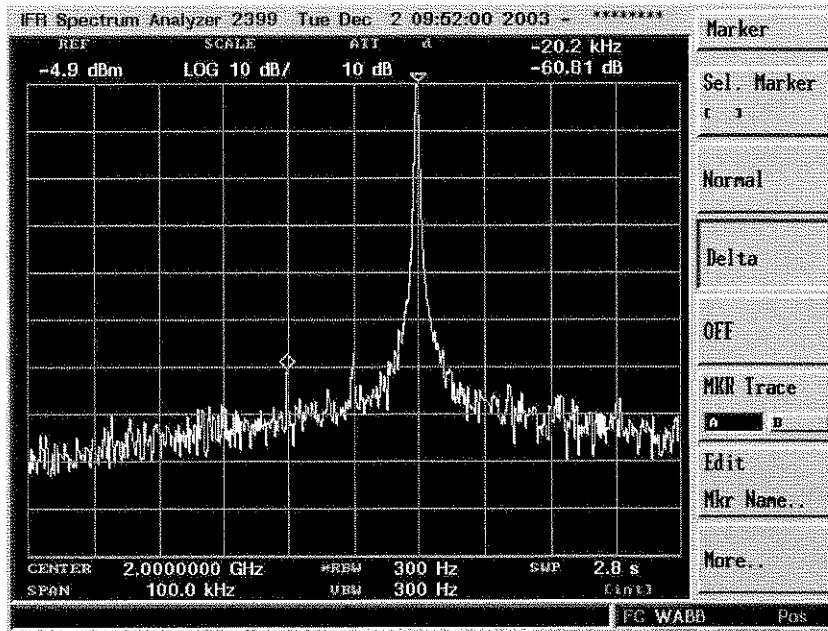

Fig. 6-8 Spectrum analyzer display showing suppressed LSB image measurement

- 9 Using the spectrum analyzer's Marker Delta facility, measure the level of the suppressed carrier leak relative to the USB as shown in Fig. 6-7.
- 10 Using the spectrum analyzer's Marker Delta facility, measure the level of the suppressed LSB relative to the USB as shown in Fig. 6-8.
- 11 To configure the UUT to test USB image suppression:

<Tone A> ■ State OFF

<Tone B> ■ State ON

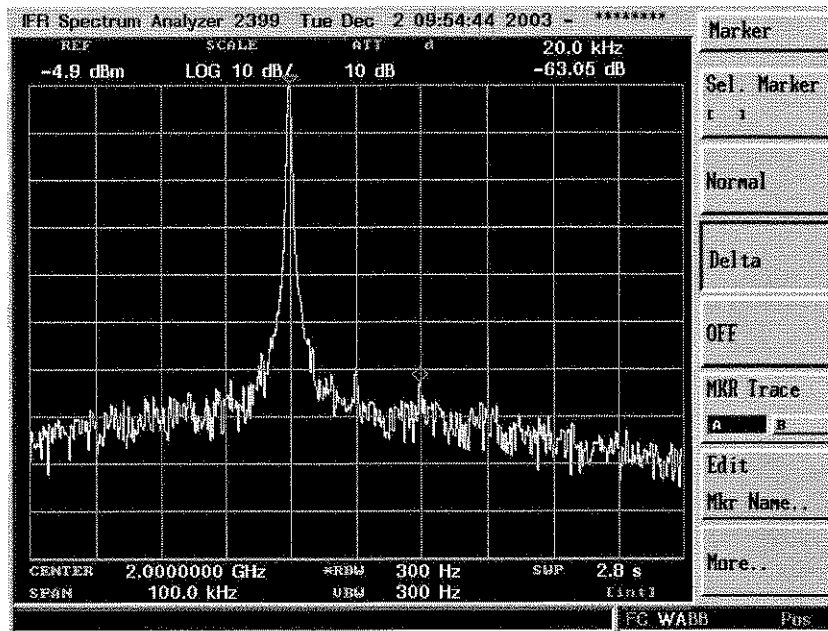

Fig. 6-9 Spectrum analyzer display showing suppressed USB image measurement

- 12 Using the spectrum analyzer's Marker Delta facility, measure the level of the suppressed USB relative to the LSB as shown in Fig. 6-9.
- 13 Record your results from steps 9 to 12 in Table 6-7.

Table 6-7 Real-time baseband IQ modulator results

Parameter	Limit	Result
Intermodulation	50 dBc	
Carrier Leak	40 dBc	
LSB image suppression	50 dBc	
USB image suppression	50 dBc	

Baseband phase generation tests

- 1 Connect the test equipment as shown in Fig. 6-5.
- 2 On the UUT set:

Freq 400 [MHz]

Lev 0 [dB]

RF (ON/OFF)

IQ MOD Int IQ (wait five seconds for the application to download)

- 3 To configure the UUT to set $\pi/4$ DQPSK modulated carrier:

SIG GEN Generic J

<Modn> ■ DPSK 4 (to select $\pi/4$ DQPSK)

<System> ■ Sym Rate 18 [kHz]

- 4 On the UUT set:

SIG GEN IQ J <Self-Cal>

Start Cal

Ensure that the IQ cal has successfully completed.

- 5 Set the spectrum analyzer to center frequency 400 MHz, span 100 kHz.
- 6 The trace on the spectrum analyzer should appear as shown in Fig. 6-10.

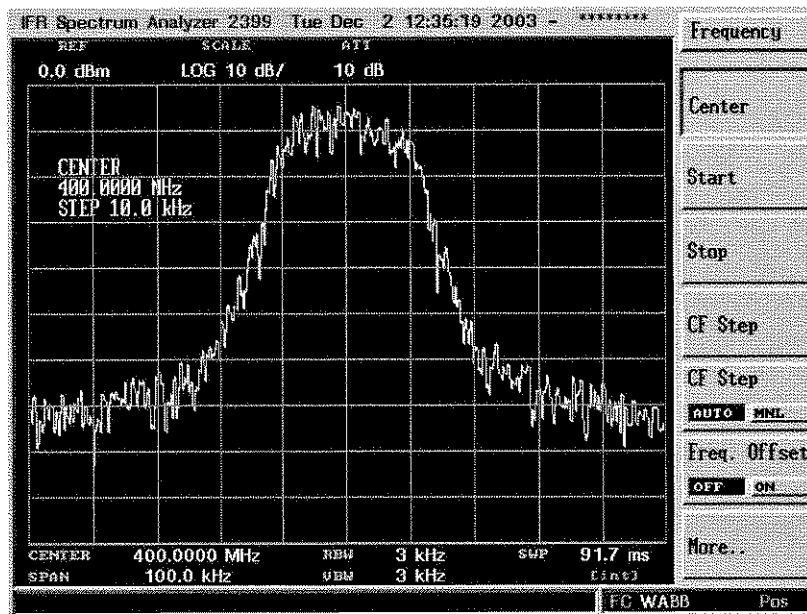

Fig. 6-10 Spectrum analyser display showing $\pi/4$ DQPSK modulated carrier

- 7 Set both channels of the oscilloscope to 0.2 V/div and the timebase to X-Y. The oscilloscope's display should appear similar to Fig. 6-11.

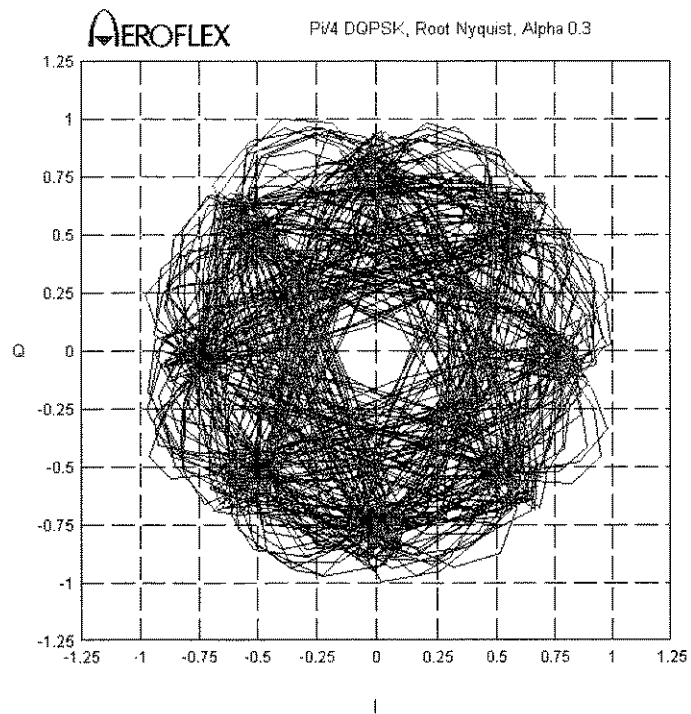

Fig. 6-11 Oscilloscope display showing $\pi/4$ DQPSK

Baseband frequency generation tests

- 1 Connect the test equipment as shown in Fig. 6-5.
- 2 On the UUT set:

Freq 900 [MHz]

Lev 0 [dB]

RF ON/OFF

IQ MOD **Int IQ** (wait five seconds for the application to download)

- 3 To configure the UUT to set GMSK modulated carrier:

SIG GEN **Generic**

<Modn> **MSK 2** (to select MSK)

<System> **Sym Rate 270.833 [kHz]**

Filter 2 (to select Gaussian)

- 4 On the UUT set:

SIG GEN **IQ** <Self-Cal>

Start Cal

Ensure that the IQ cal has successfully completed.

- 5 Set the spectrum analyzer to center frequency 900 MHz, span 1 MHz.
- 6 The trace on the spectrum analyzer should appear as shown in Fig. 6-12.

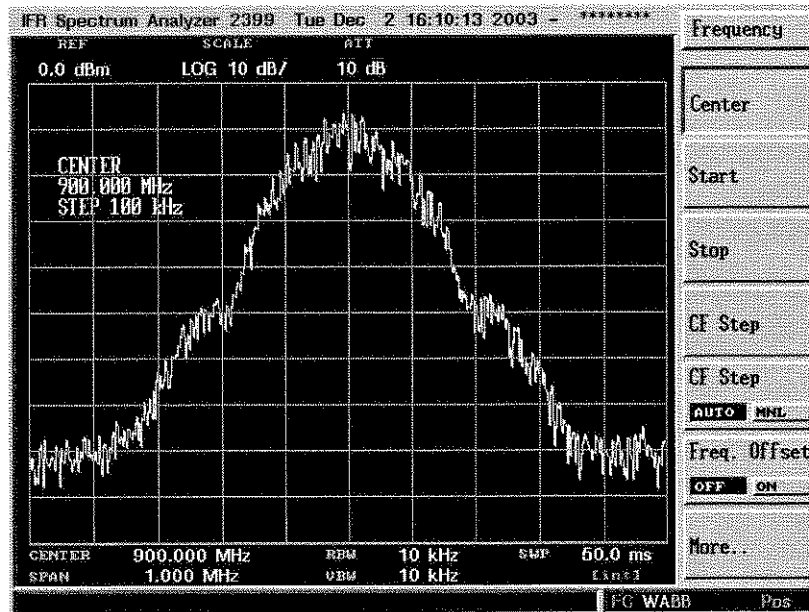

Fig. 6-12 Spectrum analyzer display showing GMSK modulated carrier

- 7 Set both channels of the oscilloscope to 0.2 V/div and the timebase to X-Y. The oscilloscope's display should appear similar to Fig. 6-13.

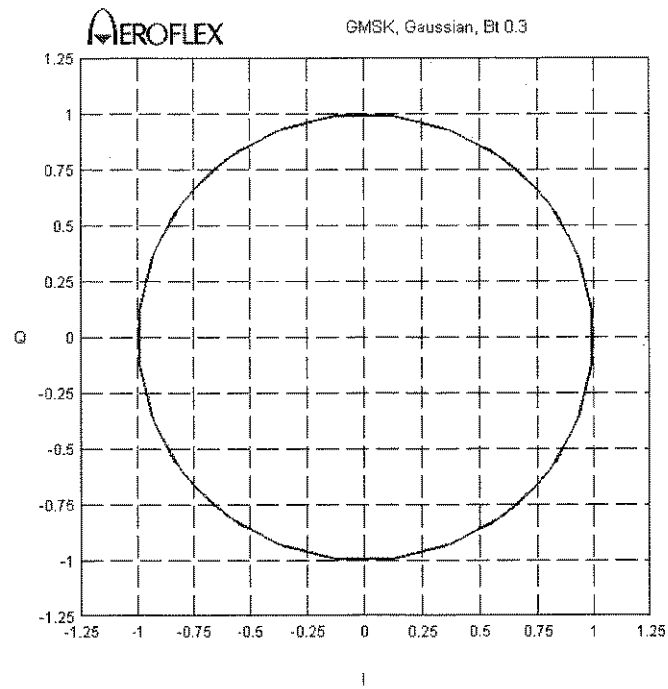
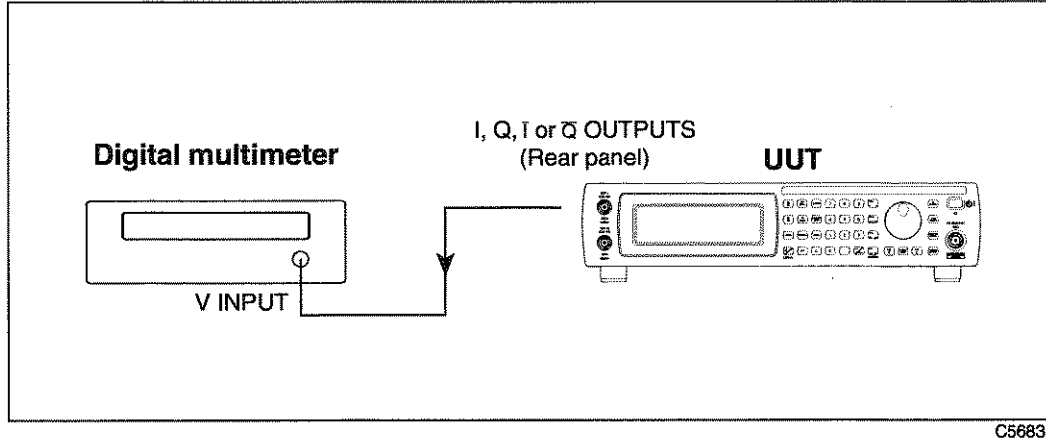

Fig. 6-13 Oscilloscope display showing GMSK

Differential IQ outputs (instruments fitted with Option 009)

To test the performance of the I, Q, \bar{I} and \bar{Q} outputs, it is necessary to generate a 20 kHz test tone on the I and Q outputs using **IQCreator**®.



C5683

Fig. 6-14 Differential IQ outputs test setup

Bias voltage accuracy

- 1 Connect the test equipment as shown in Fig. 6-14, with the cable connected to the I output.
- 2 On the UUT set:

SIG GEN IQ Start Cal <Self-Cal>

Ensure that the IQ cal has successfully completed.

IQ MOD Diff IQ <Bias> ■ I Bias 3 [V]

- 3 Measure the voltage on the DMM against the limits shown in Table 6-8.
- 4 On the UUT set:
 - I Bias -3 [V]
- 5 Measure the voltage on the DMM against the limits shown in Table 6-8.

Differential offset voltage accuracy

- 6 On the UUT set:
 - *I Bias* **0 [V]**
 - <IQ> ■ *I Offset* **300 [mV]**
- 7 Measure the voltage on the DMM against the limits shown in Table 6-8.
- 8 On the UUT set:
 - *I Offset* **-300 [mV]**
- 9 Measure the voltage on the DMM against the limits shown in Table 6-8.

Signal amplitude accuracy

- 10 On the UUT set:
 - *I Offset* **0 [V]**
 - <Catalog>

Select the 20 kHz IQ test tone.

 - <IQ> ■ *IQ Level* **4 [V]**
- 11 Measure the voltage on the DMM and convert to pk-pk by multiplying the measurement by $2\sqrt{2}$ against the limits shown in Table 6-8.
- 12 Transfer the cable to the \bar{I} output and repeat (2) to (11), noting the opposite polarity in (6) to (9).
- 13 Transfer the cable to the Q output and repeat (2) to (11) setting the ■ *Q Bias* and ■ *Q Offset* accordingly.
- 14 Transfer the cable to the \bar{Q} output and repeat (2) to (11), noting the opposite polarity in (6) to (9).

Table 6-8 Diff IQ output results

Output	Parameter	Voltage	Min	Max	Result
I	Bias voltage accuracy	3 V	2.936	3.064	
I		-3 V	-3.064	-2.936	
I	Differential offset voltage	300 mV	290.7	309.3	
I		-300 mV	-309.3	-290.7	
I	Signal amplitude accuracy	4 V	3.92	4.08	
I	Bias voltage accuracy	3 V	2.936	3.064	
I		-3 V	-3.064	-2.936	
I	Differential offset voltage	-300 mV	-309.3	-290.7	
I		300 mV	290.7	309.3	
I	Signal amplitude accuracy	4 V	3.92	4.08	
Q	Bias voltage accuracy	3 V	2.936	3.064	
Q		-3 V	-3.064	-2.936	
Q	Differential offset voltage	300 mV	290.7	309.3	
Q		-300 mV	-309.3	-290.7	
Q	Signal amplitude accuracy	4 V	3.92	4.08	
\bar{Q}	Bias voltage accuracy	3 V	2.936	3.064	
\bar{Q}		-3 V	-3.064	-2.936	
\bar{Q}	Differential offset voltage	-300 mV	-309.3	-290.7	
\bar{Q}		300 mV	290.7	309.3	
\bar{Q}	Signal amplitude accuracy	4 V	3.92	4.08	



Index

Tip: references to Chapter 3 are most likely to be concerned with front-panel operation of the instrument, whilst references to Chapter 4 are concerned solely with remote operation of the instrument.

2

2023 commands 3-132, 3-161

6

6 GHz frequency extension 5-6

A

A/B level control 2-6, 3-52, 3-71

Abbreviations

in SCPI commands 4-4

of general terms v

Abort sweep 3-114, 3-119, 4-158

list mode 4-42

About this manual ii

Acceptance testing *See* Verification testing

Accessories 1-23

Accuracy of frequency standard 3-139

Address, frequency hopping 3-74, 4-77

Address, GPIB *See* GPIB address

Address, list mode 3-121

ALC

bandwidth 3-28, 4-148

frozen mode

search 4-148

frozen mode search method 4-148

mode 3-28

mode (state) 4-149

Alt level

A/B 3-46, 3-64

attenuation 3-51, 3-68

state 3-51, 3-68

AM

applying to internal source 3-93, 3-95

change frequency during sweep 3-114, 4-55

depth 3-93, 3-95, 4-51

depth step size 4-51

external source

coupling 3-94, 4-52

input 3-5

input impedance 3-94, 4-52

sensitivity 3-94, 4-53

frequency mode 4-54

internal source

frequency 3-94, 4-53

frequency step 4-54

modulator on/off 4-59

source 3-94, 4-59

source on/off 3-94, 4-20

specification 1-13

sweep

dwell 3-112, 4-55

linear step size 3-112, 4-57

logarithmic step size 3-112, 4-57

spacing mode 3-111, 4-56

start frequency 3-111, 4-56

stop frequency 3-111, 4-58

test 6-11

AM (ALC) *See* ALC mode

ANALOG MOD key 3-7, 3-15

Analog modulation 3-91

Analog modulation mode 3-7

ARB

abort 3-44, 4-106

adjust 3-41

adjust RMS offset 3-41, 4-108

catalog of contents 3-39, 4-110

changing the sample rate 3-41, 4-108

checksum 4-110

configuration 3-42

control 3-44

copy data 4-111

display details 4-110

erase (delete) all files 4-110

erase (delete) waveform file 4-110

erase waveform file 3-40

file format 3-164, 4-106

file header 4-111

file summary 4-112

mode (single/continuous) 4-106

mode (single/multiple/continuous) 3-42

play waveform 3-44, 4-106

repeat mode 3-42, 4-107

restart 3-43, 4-107

sectors 4-106

select file 3-39, 4-111

specification 1-17

stop waveform 3-44, 4-106

trigger holdoff 3-43, 4-109

trigger mode 3-43, 4-109

tuning offset 3-41, 4-108

view current waveform 3-41

view list of entries 3-39

waveform details 3-39

ARB board 5-4

ARB function generator 4-181

ARB function generator version

control gate array 4-181

data gate array 4-181

- ARB version
 boot CPLD 4-180
 control gate array 4-180
 data gate array 4-181
Arbitrary block program data (definition) 4-7
Arrow key 3-6
Asterisk
 blanking digits 3-145
 common commands 4-11
Attenuation
 burst 3-46, 3-51, 3-64, 3-68, 4-63, 4-67
 of external device 3-31, 4-150
Attenuator 1-22, 5-4
 electronic 1-2, 3-46, 3-64
 instruments without 3-27
 mechanical 1-2
 number of operations 4-179
 pad values 3-150, 6-9
 type/part number 3-150
Auto (ALC) *See* ALC mode
Auxiliary port connector 2-6, 3-10, 3-52, 3-71
- B**
Backspace key 3-7, 3-14
Bar (in SCPI commands) 4-5
Baseband generator
 external source, RTBB (IQ) 3-85
Baseband generator on/off
 IQ 4-99
Baud rate 3-134, 4-165
Bias
 differential IQ 4-95, 4-97
Blanking, display 3-145, 4-186
Block response data (definition) 4-9
Boolean program data (definition) 4-7
Boot ROM
 part number 4-179
 version number 4-179
Bracket (in SCPI commands) 4-4
Bracket (under numbers on screen) 3-18
Broad bandwidth (ALC) *See* ALC bandwidth
Build standard of instrument 3-150
Burst attenuation
 introduction 3-46, 3-64
Burst control
 input/output 2-6, 3-9
 specification 1-15
Burst length 3-50, 3-67, 4-64, 4-70
Burst modulation source 4-21
Burst waveform 3-47, 3-65
 alt level marker repeat length 4-69
 alt level state 3-51, 3-68
 attenuation 3-51, 3-68, 4-63, 4-67
 burst duration Δ 4-64, 4-70
 clear transition points 4-72
 clear transition points in alt level list 4-67
 duration Δ 3-50, 3-67
 event duration 3-69
 event number 3-69
 external interfaces 3-52, 3-71
 fall time 3-47, 3-65, 4-64, 4-70
 list of alt level transition points 4-68
 list of burst transition points 3-69, 4-73
 marker repeat length 3-70, 4-73
 modulator on/off 4-74
 offset 3-49, 3-66, 4-65, 4-71
 profile 3-47, 3-65, 4-65, 4-71
 rise time 3-47, 3-65, 4-66, 4-72
 set parameter 3-69
 set to default 3-48, 4-109
 source for trigger 4-74
 state 3-47, 3-65, 4-74
 state of attenuation control bit 4-63, 4-67
 trigger interval 3-49, 3-66
 trigger interval, external 4-66
- C**
Calculate list values
 list mode 4-42
Calculate, list mode 3-117
Calibration
 (self) 3-37, 3-56, 3-80, 3-88, 4-174
 dates 3-155
 intervals 1-21
Cancel a request 3-143
Carrier
 CW, fixed, sweep *See* Carrier mode
Carrier frequency 3-22, 4-34
 specification 1-4
 step size 4-34
 sweep
 current frequency 3-113, 4-38
 dwell 3-112, 4-37
 linear step size 3-112, 4-39
 logarithmic step size 3-112, 4-40
 start frequency 3-111, 4-39
 step spacing 3-111, 4-38
 stop frequency 3-111, 4-40
 test 6-4
Carrier level
 mode 4-153
 offset on/off 4-151
 sweep 4-154
 dwell 3-112, 4-154
 start level 3-111, 4-155
 step level 4-155
 stop level 3-111, 4-156
Carrier mode 4-35
Carrier on/off 3-22, 4-25
Carrier phase
 set 3-23, 4-35
 set reference 4-36
Carrier sensitivity 4-37
Carrier shift *See* Frequency shift
Case (in SCPI commands) 4-5
Catalog ARB 3-39, 4-110

- Catalog DM
 - configuration files 4-114
 - data pattern files 4-116
 - Catalog, generic 3-61
 - CD-ROM ii
 - Checksum DM
 - data pattern files 4-117
 - Checksum, ARB 4-110
 - Checksum, DM 4-115
 - Chip 3-164
 - Choices (in SCPI commands) 4-5
 - Cleaning the instrument 2-12
 - Clear all memory 3-153, 4-170
 - Clear frequency offset values 3-74
 - Clear list
 - frequency hopping 4-76
 - list mode 4-42
 - Clear list to end
 - frequency hopping 4-76
 - list mode 4-42
 - Clear transition points
 - burst waveform 4-72
 - frequency hopping 4-78
 - generic source 4-128
 - internal burst 4-67
 - Clearing registers 4-12
 - Clock
 - generic modulation 3-60
 - RTBB 3-88
 - Clock source, DM 4-114
 - Clock synchronization, DM 4-114
 - Colon (in SCPI commands) 4-5
 - Colors, keyboard *See* Keyboard
 - Commands: where to find them 4-3
 - Common commands 4-11, 4-168
 - Compensation *See also* Offsets
 - cabling 3-30
 - external device 3-30
 - Compound headers 4-5
 - Condition register 4-200
 - Configuration
 - LAN 3-136
 - RS-232 3-134
 - Configuration files, DM
 - catalog 4-114
 - delete all 4-115
 - delete named file 4-115
 - download 4-115
 - select file 4-115
 - Confirm entry 3-7
 - Connections
 - auxiliary port 2-6
 - external burst 3-52, 3-71
 - LVDS connector 2-7
 - rear panel 3-9
 - RS-232 interface 2-5
 - to supply 2-4
 - Connectors 3-4
 - Continue sweep
 - list mode 4-42
 - Continuous sweep *See* Sweep
 - Control board 5-3
 - Control knob 3-8
 - Controls 3-4
 - Conventions 3-3, 4-4
 - Cooling the instrument 2-2
 - Copy data 4-111
 - Correcting an entry 3-14
 - Cosine 4-65, 4-71
 - Counter, elapsed time
 - reset 4-180
 - Coupling
 - AM external source 4-52
 - external source 3-94, 3-97
 - external source, AC/DC 3-105
 - FM external source 4-84
 - CPD (definition) 4-6
 - CRD (definition) 4-8
 - Crest factor 3-26
- ## D
- Data encoding
 - generic modulation 4-125
 - Data files, DM
 - catalog 4-116
 - checksum 4-117
 - Data rate
 - external digital source (IQ) 4-102
 - external source, RTBB (IQ) 3-87
 - Data source
 - generic modulation 3-59
 - Data: copying into the ARB 4-111
 - Date of last calibration 3-155
 - dB relative *See* Units
 - DC null
 - external source 3-97, 3-106
 - Default settings 3-124, 3-156
 - Defaults 3-142, 4-170
 - Delete a user configuration file 4-115
 - Delete a user data pattern file 4-117
 - Delete address
 - list mode 4-43
 - Delete all user configuration files 4-115
 - Delete all user data pattern files 4-117
 - Delete ARB files 3-40, 4-110
 - Delete entry
 - list mode 4-42
 - Delete point
 - frequency hopping 4-76
 - Depth
 - AM 3-93, 3-95, 4-51
 - Details, ARB waveform 3-39

- Deviation
 - FM 3-96, 3-98, 4-83
 - FSK2 generic modulation 4-131
 - FSK4 generic modulation 4-131
 - phase 3-99, 3-101
 - phase modulation 4-135
- DHCP (LAN) 3-136
- DHCP enable/disable 4-163
- Diagnostic commands 4-177
- Diagnostic utilities 3-147
- Differential IQ 3-77
 - bias mode 3-79, 4-96
 - gain 3-78, 4-95
 - I bias voltage 3-79, 4-95
 - I offset voltage 3-78, 4-96
 - level 3-78, 4-97
 - Q bias voltage 3-79, 4-97
 - Q offset voltage 3-78, 4-98
 - relative amplitudes 4-95
 - self-calibration 3-80
 - state 3-77, 4-103
- Differential IQ board 5-5
- Differential IQ board version
 - CPLD 4-181
- Differential IQ output
 - specification 1-20
- Digital modulation
 - catalog of configuration files 3-61
 - data source 3-59
 - erase configuration file 3-61
 - filter 3-57
 - modulation type 3-58
 - symbol rate 3-57
- Digital modulation tests 6-13
- Dimensions of instrument 1-21
- Direct/indirect *See* Frequency
- Disable sweep *See* Sweep type
- Disconnecting device 2-4
- Display 3-4
 - blank/unblank 4-186
 - contrast 3-144, 4-188
- DM
 - catalog of configuration files 4-114
 - catalog of data files 4-116
 - checksum 4-115
 - checksum on data files 4-117
 - clock source 4-114
 - delete a user configuration file 4-115
 - delete a user data pattern file 4-117
 - delete all user configuration files 4-115
 - delete all user data pattern files 4-117
 - download a user configuration file 4-115
 - format 4-116
 - save a user data pattern file 4-117
 - select file 4-115
 - synchronize clocks 4-114
- Documentation ii
- Dots 3-12
- Download a user configuration file 4-115
- Driver board 5-3
- Driver board version
 - CPLD 4-182
 - gate array 4-182
- Duration, burst waveform ... 3-50, 3-67, 4-64, 4-70
- Dwell 3-112
 - AM sweep step 4-55
 - carrier frequency sweep step 4-37
 - carrier level sweep step 4-154
 - FM sweep step 4-87
 - phase modulation sweep step 4-138
- Dwell time
 - list mode 4-43
- Dwell time, list mode 3-117
- E**
- Edit entries
 - list mode 3-121
- Edit values
 - frequency hopping 3-74
- Elapsed operating time 3-149, 4-180
- Electromagnetic compatibility
 - specification 1-20
- EMF/PD 3-141
- Enable mask 4-196
- Encoding
 - generic modulation 3-60
- ENTER key 3-7
- Enter sub-menus 3-6
- Erase (delete) an ARB waveform file 3-40
- Erasing a generic configuration file 3-61
- Error message 3-14, 3-127
 - listing 3-157, 4-179
- Error queue
 - all unread items 4-167
 - code and string of next item 4-168
 - code of next item 4-167
 - error/event codes 4-167
 - number of unread items 4-168
- Error status 3-8
- Ethernet
 - address 4-163
 - hostname 4-164
 - MAC address 4-164
- Event duration
 - burst 3-69
 - frequency hopping 3-75
- Event number
 - burst 3-69
 - frequency hopping 3-75
- Event register 4-200
- Event status register
 - read 4-12
 - set 4-12
- Exit sub-menus 3-6
- Ext Source* 3-94
- External AM source
 - input 3-5

- External analog source
 - impedance (IQ) 4-98
 - External digital source
 - data rate 4-102
 - filter Gaussian, BT (IQ) 4-99
 - filter Nyquist, BT (IQ) 4-100
 - filter on/off 4-101
 - filter root Nyquist, alpha (IQ) 4-100
 - filter type 4-101
 - RMS value 4-102
 - External FM source
 - input 3-5
 - External IQ
 - source on/off 4-22
 - External IQ, RTBB
 - clock 3-88
 - data rate 3-87
 - filter 3-88
 - impedance 3-84
 - internal baseband 3-85
 - on/off 3-84, 3-87
 - RMS value 3-87
 - self-calibration 3-86, 3-88
 - External modulation
 - specification 1-16
 - External source
 - coupling (AC/DC) 3-105
 - coupling (AM) 4-52
 - coupling (FM) 3-97, 4-84
 - coupling AM 3-94
 - DC null 3-97, 3-106, 4-84
 - impedance (AM) 4-52
 - impedance (FM) 4-84
 - impedance (phase modulation) 4-136
 - input impedance 3-94, 3-97, 3-106
 - sensitivity 3-106
 - sensitivity (AM) 3-94, 4-53
 - sensitivity (FM) 3-97, 4-85
 - sensitivity (phase modulation) 3-100, 4-136
 - set-up 3-105
 - external digital source (IQ) 4-100
 - generic source (IQ) 4-127
 - Filter, root Nyquist, alpha
 - external digital source (IQ) 4-100
 - generic source 4-127
 - FM
 - applying to internal source 3-96, 3-98
 - change frequency during sweep 3-114, 4-87
 - deviation 3-96, 3-98, 4-83
 - deviation step size 4-83
 - external source
 - coupling 3-97, 4-84
 - DC null 3-97, 4-84
 - input 3-5
 - sensitivity 3-97, 4-85
 - external source input impedance 4-84
 - internal source
 - frequency 3-97, 4-85
 - frequency step 4-86
 - mode 4-86
 - modulation source on/off 3-97
 - modulator on/off 4-91
 - source 4-91
 - source on/off 4-22
 - specification 1-12
 - sweep
 - dwelt 3-112, 4-87
 - linear step size 3-112, 4-89
 - logarithmic step size 3-112, 4-89
 - spacing mode 3-111, 4-88
 - start frequency 3-111, 4-88
 - stop frequency 3-111, 4-90
 - FM test 6-10
 - Format ARB 4-106
 - Format internal baseband 3-85
 - Format, DM 4-116
 - Frequency
 - internal source (AM) 3-94, 4-53
 - internal source (FM) 3-97, 4-85
 - internal source (phase modulation) 4-137
 - internal source (PM) 3-100
 - reference 3-9, 3-138, 4-29
 - set carrier 3-22, 4-34
 - tone modulation 3-62, 3-63
 - Frequency coverage of 3410 Series 1-1
 - Frequency extension module 5-6
- F**
- Fall time
 - burst waveform 3-47, 3-65, 4-64, 4-70
 - Fan speed 2-2
 - File details, generic 3-61
 - Filter
 - external source, RTBB (IQ) 3-88
 - generic modulation 3-57
 - Filter on/off
 - external digital source (IQ) 4-101
 - Filter type
 - external digital source (IQ) 4-101
 - generic source 4-128
 - Filter, Gaussian, BT
 - external digital source (IQ) 4-99
 - generic source 4-126
 - Filter, Nyquist, BT

- Frequency hopping 3-72
 - clear list 4-76
 - clear list to end 4-76
 - clear transition points 4-78
 - delete point 4-76
 - editing address 3-74
 - editing offset values 3-74
 - event duration 3-75
 - event number 3-75
 - insert addresses and values 4-76
 - insert point 4-76
 - list of burst transition points 4-79
 - marker repeat length 3-76, 4-79
 - mode, linear or random 4-78
 - modulator on/off 4-80
 - PN code 3-73, 4-78
 - sequence length 3-73
 - source for trigger 4-80
 - source on/off 4-21
 - start address 3-73
 - state 3-72, 4-80
 - tables of offset values 3-73
 - Frequency shift 3-24
 - Frequency span 3-88
 - Frequency span (self-calibration) . 3-37, 3-56, 3-86
 - Frequency standard 3-138, 4-29
 - I/O 3-9
 - specification 1-16
 - Frequency value, list mode 3-121
 - Frozen (ALC) *See* ALC mode
 - Function label 3-4, 3-33
 - Functions
 - selecting 3-12
 - Fuse and holder 2-4, 3-9
- G**
- Gain
 - differential IQ 4-95
 - Gain of external device 3-30, 4-150
 - Gaussian 4-65, 4-71
 - Generic modulation 3-57
 - data encoding 4-125
 - deviation, FSK2 4-131
 - deviation, FSK4 4-131
 - encoding 3-60
 - marker repeat length 4-130
 - modulation type 4-130
 - set symbol rate 4-132
 - source 4-125
 - user file (data format) 4-126
 - Generic source
 - clear transition points 4-128
 - filter Gaussian, BT 4-126
 - filter Nyquist, BT 4-127
 - filter root Nyquist, alpha 4-127
 - filter type 4-128
 - list of transition points 4-129
 - marker select 4-128
 - Getting started 3-11
 - Goods-in checks 2-4
 - GPIB
 - address 3-132, 4-164
 - interface 3-9, 4-161
- H**
- Handshake, hardware/software 3-134, 4-166
 - Header on each page 3-3
 - Header, ARB 4-111
 - Highlight 3-12
 - Host name (LAN) 3-136
 - Hostname 4-164
- I**
- I / EXT AM 3-5
 - I bias, differential IQ 3-79
 - I offset, differential IQ 3-78
 - I/O sockets 3-9
 - Identification of instrument 4-13
 - IEEE 488.2 3-9, 4-3, 4-11
 - Impedance
 - external analog source (IQ) 4-98
 - external source 3-106
 - external source (AM) 3-94, 4-52
 - external source (FM) 3-97, 4-84
 - external source (phase modulation) 3-100, 4-136
 - external source, RTBB (IQ) 3-84
 - Increment 3-24
 - AM 4-51
 - carrier 4-34
 - FM 4-83
 - phase modulation 4-135
 - Index 3-3
 - Initiate ARB *See* ARB
 - Initiate sweep *See* Sweep
 - list mode 4-43
 - Insert addresses/values
 - frequency hopping 4-76
 - Insert frequency and power values
 - list mode 4-42
 - Insert frequency values
 - list mode 4-43
 - Insert list entry
 - list mode 4-44
 - Insert point
 - frequency hopping 4-76
 - Insert power values
 - list mode 4-45
 - Installation requirements 2-2
 - Instrument configuration, summary of 3-129
 - Instrument status 4-203
 - Int source
 - AM relative phase 3-95, 4-60
 - FM relative phase 3-98, 4-92
 - phase modulation relative phase .. 3-101, 4-143

- Interface type 3-132, 4-165
 - Internal IQ
 - self-calibration 3-56
 - source on/off 4-22
 - Internal IQ, ARB
 - self-calibration 3-37
 - source on/off 3-36
 - Internal IQ, RTBB
 - LVDS on/off 3-55
 - on/off 3-55
 - source on/off 3-55
 - Internal oscillator
 - specification 1-16
 - Internal source 3-102
 - AM waveshape 4-58
 - FM waveshape 4-90
 - frequency 3-102, 3-104
 - frequency (AM) 4-53
 - frequency (FM) 4-85
 - frequency (phase modulation) 4-137
 - phase modulation waveshape 4-142
 - waveshape 3-103, 3-104
 - Interpolator 3-164
 - IP address 3-136
 - IQ
 - baseband generator on/off 4-99
 - differential 3-77
 - modulator on/off 4-103
 - modulator test 6-13
 - source 4-103
 - IQ external analog source
 - input impedance 4-98
 - IQ external digital source
 - data rate 4-102
 - filter Gaussian, BT 4-99
 - filter Nyquist, BT 4-100
 - filter on/off 4-101
 - filter root Nyquist, alpha 4-100
 - filter type 4-101
 - RMS value 4-102
 - IQ external source
 - input impedance 3-84
 - IQ external source, RTBB
 - baseband generator 3-85
 - data rate 3-87
 - filter 3-88
 - RMS value 3-87
 - IQ external, RTBB *See External IQ*
 - IQ external, RTBB *See External IQ*
 - IQ gain, differential IQ 3-78
 - IQ input level 3-29
 - IQ internal *See Internal IQ. See Internal IQ*
 - IQ level, differential IQ 3-78
 - IQ MOD key 3-7
 - IQ modulation
 - ARB 3-35
 - real-time baseband 3-53
 - specification 1-14
 - IQ modulation mode 3-7
 - IQCreator ii, 3-45
- ## K
- Keyboard 3-6
 - lock/unlock 3-154, 4-168
 - what the colors mean 3-6
 - Keypad command 3-13
 - Knob, control 3-8
 - KNOB/STEP key 3-18
- ## L
- LAN 3-136
 - DHCP 3-136
 - host name 3-136
 - IP address 3-136
 - net mask 3-136
 - Language
 - set SCPI/2023 3-133, 4-169
 - Last keyed-in value, shift from 3-24
 - LCD
 - contrast 3-144, 4-188
 - size/calibrate 3-145
 - LED 3-5
 - standby/power 2-4, 3-11
 - Length of sequence
 - frequency hopping 3-73
 - Level *See RF level*
 - differential IQ 4-97
 - Level setting time 1-6
 - License, software, CDMA 1-22
 - Limit, output power 3-25, 4-152
 - Limits, measurement 6-3
 - Linear/logarithmic spacing *See Sweep: spacing*

- List mode 1-16
 calculate list values 4-42
 clear list 4-42
 clear list to end 4-42
 delete address 4-43
 delete entry 4-42
 dwell time 4-43
 editing address 3-121
 editing list entries 3-121
 frequency value 3-121
 insert frequency and power values 4-42
 insert frequency values 4-43
 insert list entry 4-44
 insert power values 4-45
 modify list values 4-47
 pause sweep 4-44
 power level value 3-121
 reset sweep 4-45
 single/continuous sweep 4-44
 start address 4-45
 start sweep 4-43
 stop address 4-46
 stop sweep 4-42
 trigger 4-46
 trigger signals 2-6
 trigger slope 4-47
- List sweep
 calculate 3-117
 controlling the output 3-118
 current address 3-118
 defining parameters 3-117
 defining the configuration 3-115
 dwell time 3-117
 pause 3-119
 single/continuous 3-116
 start 3-118
 start address 3-117
 step down list address 3-119
 step up list address 3-119
 stop 3-119
 stop address 3-117
 tables of offset values 3-120
 trigger 3-116
- LOCAL key 3-6, 3-154
Local lockout (LLO) 3-129
Local operation 3-6, 3-129
Lock/unlock
 instrument 3-152
 keyboard 3-154, 4-168
Logic level 4-198
Loss *See* System loss
LVDS connector 2-7, 3-10
 on/off 3-55
LVDS on/off 4-20
LVDS output 3-85
- M**
MAC address 4-164
- Main screen 3-11
Marker bit 2-6, 2-10, 3-46, 3-49, 3-64, 3-165, 4-74
Marker select
 generic source 4-128
Markings *See* Conventions
Memory
 erase all stores 3-153, 4-170
 power-on
 default or memory store 4-170
 power-on location 3-142, 3-156, 4-169
Memory recall 3-7, 3-124, 4-170
Memory save 3-7, 3-123, 4-170
Menu
 analog modulation mode 3-7
 IQ modulation mode 3-7
 SIG GEN 3-7
 sweep 3-7
 utilities 3-7
Minus key 3-7
MOD ON/OFF key 3-8, 4-24
Mode
 AM 4-54
 ARB 4-106
 carrier frequency 4-35
 carrier level 4-153
 differential IQ 3-79, 4-96
 external IQ self-calibration, RTBB .. 3-86, 3-88
 FM 4-86
 internal IQ self-calibration, ARB 3-37
 internal IQ self-calibration, RTBB 3-56
 noise 4-153
 phase modulation 4-138
 RF 3-26
 sweep 4-158
Mode, linear or random
 frequency hopping 4-78
Model number 3-148
Moderate bandwidth (ALC) ... *See* ALC bandwidth
Modulation 1-12
 available combinations 3-33
 depth 3-93, 3-95
 generic 3-58
 key points 1-2
 pulse 3-107
 Why two commands? 4-18
Modulation mode 3-15
 analog 3-91
 IQ, ARB 3-35
 IQ, RTBB 3-53
Modulation on/off
 all outputs 3-8, 4-24
Modulation paths
 relative phase 3-104
Modulation source on/off
 AM 3-94
 FM 3-97
 phase modulation 3-100
 pulse 3-107

Modulator on/off
 AM 4-59
 burst 4-74
 FM 4-91
 frequency hopping 4-80
 IQ 4-103
 phase modulation 4-143
 pulse 4-146
 Multi band (self-calibration) 3-37, 3-56, 3-86

N

Narrow bandwidth (ALC) *See* ALC bandwidth
 Negative transition filter 4-197
 Negative transition mask 4-197
 Negative values 3-62, 3-63
 Net mask 3-136
 Noise mode 3-25, 4-153
 Nomenclature *See* Conventions
 Normal (ALC) *See* ALC mode
 NR1, NR2, NR3 (definition) 4-8
 NRf (definition) 4-6
 Null modem cable 2-5
 Number, model 3-148
 Numeric entry 3-12
 Numeric keypad 3-7, 3-18
 numeric_value program data (definition) 4-6

O

Offset 3-18, 3-24
 attenuation 3-31, 4-150
 burst waveform 3-49, 4-65, 4-71
 enabled/disabled 3-31, 4-151
 gain 3-30, 4-150
 loss 3-31, 4-151
 oscillator 4-28
 status 3-31, 4-151
 Offset value, frequency hopping 3-74
 Offset values
 frequency hopping 3-73, 3-120
 Offset voltage
 differential IQ 4-96, 4-98
 Offset, burst waveform 3-66
 Operating conditions *See* Rated range of use
 Operating time *See* Elapsed time
 Operation complete 4-13
 Operation, fundamentals of 3-19
 Optimization of RF power 3-26, 4-153
 Optimize RF level accuracy 3-27, 4-154
 Optimized (self-calibration) 3-37, 3-56, 3-80, 3-86, 3-88
 Option 001 3-27
 Option 002 1-2
 Option 003 3-46, 3-51, 3-107
 Option 005 3-35
 Option 006 3-107
 Option 007 3-5

Option 008 3-53
 Option 009 3-77
 Option 010 3-115
 Optional accessories 1-23
 Options 3-35, 3-53
 available 1-22
 fitted to instrument 3-148, 4-14, 4-183
 Oscillator *See* Reference oscillator
 Output *See* RF output

P

Parameter ranges in remote commands 4-3
 Parity *See* Serial interface
 Part number
 attenuator 3-150
 boot ROM 4-179
 software 3-147
 sub-assembly 3-150
 Password
 administrator 3-152
 user 3-152
 Patent protection iv
 Patents information 3-149
 Path
 AM on/off 3-94, 4-59
 burst on/off 3-47, 4-74
 FM on/off 3-97, 4-91
 frequency hopping on/off 4-80
 IQ ARB, on/off 3-36
 IQ on/off 4-103
 phase modulation on/off 3-100, 4-143
 Path, burst, on/off 3-65
 Path, pulse, on/off 3-107
 Paths
 portrayal of 3-92
 Pause list sweep 3-119
 Pause sweep *See* Sweep
 Performance data 1-4
 Phase
 AM2 wrt AM1 3-95, 4-60
 carrier 3-23, 4-35
 carrier reference 3-23, 4-36
 FM2 wrt FM1 3-98, 4-92
 mod path 2 wrt path 1 3-104
 offset from internal oscillator 3-23
 PM2 wrt PM1 3-101, 4-143

- Phase modulation
- applying to internal source 3-99
 - change frequency during sweep 3-114, 4-139
 - deviation 3-99, 4-135
 - deviation step size 4-135
 - external source
 - input impedance 3-100, 4-136
 - sensitivity 3-100, 4-136
 - frequency mode 4-138
 - internal source
 - frequency 3-100, 4-137
 - frequency step 4-137
 - modulator on/off 4-143
 - select source 3-100, 4-142
 - source on/off 3-100, 4-23
 - specification 1-12
 - sweep
 - dwell 3-112, 4-138
 - linear step size 3-112, 4-140
 - logarithmic step size 3-112, 4-141
 - spacing mode 3-111, 3-112, 4-139
 - start frequency 3-111, 4-140
 - stop frequency 3-111, 4-141
- Phase noise optimization 3-22, 4-36
- Phase reference, carrier 3-23
- Phase shift 3-23
- Phase, carrier *See* Carrier phase
- PM *See* Phase modulation
- PN code
- frequency hopping 3-73
- Positioning the instrument 2-2
- Positive transition filter 4-197
- Positive transition mask 4-197
- Power cords 2-3
- Power level
- set RF 4-149
- Power level value, list mode 3-121
- Power specification 1-21
- Power switch 3-9
- Power-on 3-11, 6-3
- defaults 3-142, 4-170, 6-3
- Preset
- burst waveform 3-48, 4-109
 - enable/transition filter registers 4-197
- Preset instrument to default 3-142, 4-170
- Preset RS-232 to default 3-135
- Preset: quick procedure 3-11
- Profile
- burst waveform 3-65, 4-65, 4-71
- Profile, burst waveform 3-47
- Program data (in remote commands) 4-5
- Program headers 4-5
- Programming language 3-132
- Protection, reverse power 1-7, 3-5, 3-25, 3-125, 4-152
- reset 4-24
 - trip count 3-125, 3-150
 - trip state 4-24
- PULM *See* Pulse modulation
- Pulse modulation 3-107
- input 3-10
 - modulator on/off 4-146
 - set source 4-146
 - source on/off 3-107, 4-23
 - specification 1-17
- ## Q
- Q \ EXT FM 3-5
- Q bias, differential IQ 3-79
- Q offset, differential IQ 3-78
- Queue flag 4-205
- Quick preset 3-11
- ## R
- Ranges of parameters in remote commands 4-3
- Rated range of use
- specification 1-21
- RCL key 3-7
- Real-time baseband board 5-4
- Real-time baseband tests 6-15
- Rear-panel
- connectors 3-9
 - outputs *See* Options
- Recall all settings 3-124, 4-170
- Reference oscillator 3-138, 4-29
- accuracy 6-4
 - offset 3-139, 4-28
- Reference, carrier phase, 0° 3-23
- Registers
- AM frequency status 4-210
 - ARB frequency status 4-213
 - CALibration frequency status 4-214
 - DM frequency status 4-213
 - FM frequency status 4-211
 - IQ frequency status 4-212
 - OPERation status 4-209
 - PM frequency status 4-211
 - pulse modulation frequency status 4-212
 - questionable frequency status 4-210
 - questionable power status 4-209
 - questionable status 4-208
 - ROSCillator frequency status 4-214
 - standard event 4-207
- Remote configuration 3-132, 4-165
- Remote control
- key points 1-3
 - specification 1-20
- Remote operation 3-6, 4-1
- references to 3-3
 - view current configuration 3-129
- Remote status reporting 4-203
- Repeat
- ARB 4-107

- Repeat length
 alt level burst marker 4-69
 generic marker 4-130
- Repeat length of marker
 burst 3-70
 frequency hopping 3-76
- Reset
 instrument 3-142, 4-14
 output modulation 4-23
 reverse power trip 4-24
 sweep *See Sweep*
- Resolution *See also Step*
 rotary control 3-18, 3-23, 3-104
- Response data (in remote commands) 4-8
- Reverse power *See Protection*
- RF attenuation
 specification 1-15
- RF board 5-2
- RF board version
 CPLD 4-182
 gate array 4-182
- RF level 3-25, 4-149
 accuracy 1-2, 6-5
 attenuation test 6-9
 for offset 3-30
 limit 3-25, 4-152
 step size 4-152
 tests 6-5
 units 3-141
- RF mode 3-26
- RF on/off 4-25
- RF ON/OFF key 3-8, 3-22, 4-25
- RF optimization 3-26, 4-153
- RF output
 key points 1-2
 specification 1-5
- Rise time
 burst waveform 3-47, 3-65, 4-66, 4-72
- RMS offset, ARB 3-41, 4-108
- RMS value
 external digital source (IQ) 4-102
 external source, RTBB (IQ) 3-87
- Routine safety testing and inspection 2-12
- RPP *See Protection, reverse power*
- RS-232 2-5, 3-9, 3-134
- RTBB
 specification 1-18
- RTBB board version
 CPLD 4-182
 gate array 4-183
- S**
- Safety information ii
 specification 1-20
- Sample rate 3-165
- Save a user data pattern file 4-117
- Save all settings 3-123, 4-170
- SAVE key 3-7
- Scaled (ALC) *See ALC mode*
- SCPI 3-133, 4-3, 4-169
- Screen
 inverted video 3-3
- Scrolling up and down 3-6
- Sectors *See ARB*
- Select file *See DM. See ARB*
- Self-calibration 3-37, 3-56
 RTBB 3-86, 3-88
- Self-calibration, ARB
 manual/automatic start 3-38
 spot frequency/frequency band 3-37
- Self-calibration, differential IQ 3-80
- Self-calibration, RTBB
 manual/automatic start 3-89
 spot frequency/frequency band 3-88
 spot frequency/frequency band/multi-
 band/frequency list 3-56
- Self-test 4-15
- Sensitivity *See also Resolution*
 carrier reference 4-37
 control knob 3-8
 external source (AM) 3-94, 4-53
 external source (FM) 3-97, 4-85
 external source (phase modulation) 3-106, 4-136
 of controls
 AM 4-60
 FM 4-92
 PM 4-144
 rotary control 3-23
- Serial interface
 baud rate 3-134, 4-165
 handshake 3-134, 4-166
 parity 3-135, 4-166
 stop bits 3-134, 4-167
- Serial number
 attenuator 3-150
 of instrument 3-148
 sub-assembly 3-150
- Service request enable register
 set 4-14
- Set carrier 0° reference 3-23

- Setting up
 - applying AM to internal source 3-93
 - applying FM to internal source 3-96
 - applying PM to internal source 3-99
 - ARB 3-39
 - burst waveforms 3-46, 3-64
 - carrier frequency 3-21
 - carrier phase 3-23
 - Diff IQ 3-81
 - differential IQ 3-77
 - external analog IQ, RTBB 3-84
 - external digital IQ, RTBB 3-87
 - external sources 3-105
 - frequency hopping 3-72
 - generic modulation 3-57
 - internal IQ, ARB 3-36
 - internal IQ, RTBB 3-55
 - internal source 3-102
 - level offsets 3-30
 - memory recalls 3-124
 - memory saves 3-123
 - modulation 3-33
 - pulse modulation 3-107
 - RF level 3-21
 - sweeps 3-109
 - tones 3-62
 - utilities 3-131
- Settings
 - recall all 3-124, 4-170
 - save all 3-123, 4-170
 - storing 3-131
- Shape *See* Waveshape
- Shift, frequency *See* Frequency shift
- Shift/increment 3-7, 3-24
- SIG GEN key 3-7, 3-21
- Signal paths, in instrument 5-2
- Single sweep 3-110
- Slope
 - sweep *See* Sweep
- Soft box 3-13, 3-113, 3-118
- Soft tabs 3-3, 3-13
- Software
 - license, CDMA 1-22
 - part number 3-147
 - upgrades 3-9, 3-134
 - version date 3-147
 - version number 3-11, 3-147
- Solid box (■) 3-40, 3-61
- Source
 - burst control 4-74
 - frequency hopping control 4-80
 - generic modulation 4-125
 - internal 3-102
 - select AM 4-59
 - select FM 4-91
 - select IQ 4-103
 - select phase modulation 4-142
 - select pulse modulation 4-146
- Source on/off
 - AM 3-94, 4-20
 - external IQ 4-22
 - external IQ, RTBB 3-84, 3-87
 - FM 3-97, 4-22
 - frequency hopping 4-21
 - phase modulation 4-23
 - SOURCE ON/OFF key 3-8, 3-17, 4-20
 - Specifications of instrument 1-4
 - Spectral purity
 - specification 1-8
 - SRQ 4-199, 4-200
 - Stability of instrument 2-2
 - Standby 3-5, 3-154
 - Stand-off 6-2
 - Start address
 - frequency hopping 3-73
 - list mode 4-45
 - Start address, list mode 3-117
 - Start list sweep 3-118
 - Start sweep *See* Sweep
 - list mode 4-43
 - State
 - AM 3-94, 4-20
 - attenuation control bit 4-63, 4-67
 - burst waveform 3-47, 3-65, 4-21
 - differential IQ 3-77
 - frequency hopping 3-72
 - tone modulation 3-62, 3-63
 - Status
 - of hardware 3-148
 - of software 3-147
 - offset *See* Offset status
 - preset enable and transition filters 4-197
 - read event register 4-196
 - read register 4-196
 - set enable mask 4-196
 - set negative transition filter 4-197
 - set positive transition filter 4-197
 - Status byte
 - read by *STB? 4-203
 - read by serial poll 4-204
 - Status byte value 4-15
 - Status data structure 4-206
 - Status message, sweep 3-113, 3-118
 - Status register
 - read contents 4-196
 - Status reporting 4-198
 - Step points *See* Sweep: spacing
 - Step size 3-7, 3-24
 - AM 4-54
 - carrier 4-38
 - carrier frequency 4-34
 - carrier level 4-152
 - FM 4-86
 - phase modulation 4-137
 - Step size, sweep *See* Sweep
 - Step time, sweep *See* Sweep
 - Step/control knob 3-8
 - Steps, adjusting values in 3-8, 3-18

- Stop address
 - list mode 4-46
 - Stop address, list mode 3-117
 - Stop ARB *See* ARB abort
 - Stop bits *See* Serial interface
 - Stop sweep
 - list mode 4-42
 - Storage 2-12
 - specification 1-21
 - Storing settings 3-131
 - String program data (definition) 4-6
 - String response data (definition) 4-8
 - Sub-assembly, serial/part number 3-150
 - Sub-menu 3-12
 - Subsector 3-164
 - Summary of ARB file *See* ARB
 - Sweep 3-109
 - AM
 - change frequency during sweep 4-55
 - dwell 3-112, 4-55
 - linear step size 3-112, 4-57
 - logarithmic step size 3-112, 4-57
 - spacing mode 3-111, 4-56
 - start frequency 3-111, 4-56
 - stop frequency 3-111, 4-58
 - carrier
 - spacing the step points 4-38
 - carrier frequency
 - current frequency 4-38
 - dwell 3-112, 4-37, 4-154
 - linear step size 3-112, 4-39
 - logarithmic step size 3-112, 4-40
 - start frequency 3-111, 4-39
 - stop frequency 3-111, 4-40
 - carrier level
 - set level 4-154
 - set level 3-113
 - start level 3-111, 4-155
 - step level 4-155
 - stop level 3-111, 4-156
 - continue 3-113, 4-158
 - controlling the output 3-113
 - current frequency/level 3-113
 - defining parameters 3-111
 - defining the configuration 3-109
 - FM
 - change frequency during sweep 4-87
 - dwell 3-112, 4-87
 - linear step size 3-112, 4-89
 - logarithmic step size 3-112, 4-89
 - spacing mode 3-111, 4-88
 - start frequency 3-111, 4-88
 - stop frequency 3-111, 4-90
 - initiate 3-113, 4-158
 - list mode
 - abort 4-42
 - continue 4-42
 - initiate 4-43
 - pause 4-44
 - reset 4-45
 - pause 3-114, 4-158
 - phase modulation
 - change frequency during sweep 4-139
 - dwell 3-112, 4-138
 - linear step size 3-112, 4-140
 - logarithmic step size 3-112, 4-141
 - spacing mode 3-111, 4-139
 - start frequency 3-111, 4-140
 - stop frequency 3-111, 4-141
 - reset 3-114, 4-158
 - single/continuous 3-110, 4-158
 - spacing the step points 3-111
 - specification 1-16
 - start 3-113, 4-158
 - start frequency/level 3-111
 - step down the frequency/level 3-114
 - step size 3-112, 4-39, 4-155
 - step time 3-112, 4-37, 4-154
 - step up the frequency/level 3-114
 - stop 3-114, 4-158
 - stop frequency/level 3-111
 - trigger 3-110, 4-159
 - trigger slope 3-110, 4-159
 - type 3-109
 - SWEEP key 3-7
 - Switch
 - power 2-4, 3-9, 3-11
 - standby 2-4, 3-5, 3-11
 - Symbol rate
 - generic modulation 3-57, 4-132
 - Synchronize clocks, DM 4-114
 - System loss
 - in cabling 3-31, 4-151
- ## T
- TAB key 3-6, 3-13
 - Technical description 5-1
 - Temperature range
 - in operation 1-21
 - in storage 2-12
 - Terminating an entry 3-12
 - Terminators (in remote commands) 4-9
 - Test equipment, recommended 6-2
 - Test remote interface 4-15
 - Text *See* Conventions
 - Time
 - elapsed since last reset 4-180
 - in operation 4-180
 - per sweep step *See* Dwell
 - reset counter 4-180
 - Tone
 - frequency 4-120, 4-121
 - level 4-121
 - on/off 4-120, 4-122
 - Tone modulation 3-62
 - frequency 3-62, 3-63
 - state 3-62, 3-63

- Transition points
 - clear burst marker 4-72
 - clear frequency hopping marker 4-78
 - clear generic modulation 4-128
 - clear internal burst 4-67
 - list alt level 4-68
 - list generic source 4-129
 - Transition register 4-200
 - Trigger
 - sweep *See* Sweep
 - Trigger interval
 - burst waveform 3-49, 3-66
 - Trigger mode, ARB *See* ARB
 - Trigger slope
 - sweep *See* Sweep
 - Trigger waveform
 - burst waveform, internal 4-72
 - Tuning offset (ARB) *See* ARB
 - Tuning offset (reference oscillator) 3-139
 - Tuning value (reference oscillator) 4-28
 - save 4-28
 - Type
 - generic modulation 4-130
- U**
- Units of measurement 3-7
 - power and voltage 3-141, 4-172
 - Upgrades, software 3-9, 3-134
 - User cal 4-174
 - User data format
 - generic modulation 4-126
 - User password *See* Password
 - Utilities 3-131
 - UTILITIES key 3-7
- V**
- Ventilation 2-2
 - Verification 6-1
 - Version
 - ARB boot CPLD 4-180
 - ARB control gate array 4-180
 - ARB data gate array 4-181
 - ARB function generator control gate array 4-181
 - ARB function generator data gate array .. 4-181
 - differential IQ board CPLD 4-181
 - driver board CPLD 4-182
 - driver board gate array 4-182
 - of boot ROM 4-179
 - of instrument 1-23
 - of software 3-147
 - RF board CPLD 4-182
 - RF board gate array 4-182
 - RTBB board CPLD 4-182
 - RTBB board gate array 4-183
- View**
- options 3-148
 - patents 3-149
- Virtual front panel** 3-167
- color palette 4-192
 - compression scheme 4-192
 - display enable 4-193
 - key press commands 4-191
 - key release commands 4-191
 - return all data 4-190
 - return partial data 4-190
 - rotary control 4-192
 - touchscreen press 4-193
 - touchscreen release 4-193
- Visual inspection** 2-2
- Voltage selection** 2-4
- VRMS/VPK** *See* Sensitivity
- W**
- Warm-up time 1-4, 1-16, 6-2
 - Warranty period 1-21
 - Waveshape
 - AM 4-58
 - FM 4-90
 - internal source 3-103, 3-104
 - phase modulation 4-142
- Φ**
- ΦM *See* Phase modulation

AEROFLEX INTERNATIONAL LTD. SOFTWARE LICENCE AND WARRANTY

This document is an Agreement between the user of this Licensed Software, the Licensee, and Aeroflex International Limited, the Licensor. By opening this Software package or commencing to use the software you accept the terms of this Agreement. If you do not agree to the terms of this Agreement please return the Software package unopened to Aeroflex International Limited or do not use the software.

1. DEFINITIONS

The following expressions will have the meanings set out below for the purposes of this Agreement:

Add-In Application Software	Licensed Software that may be loaded separately from time to time into the Equipment to improve or modify its functionality
Computer Application Software	Licensed Software supplied to run on a standard PC or workstation
Designated Equipment	the single piece of Equipment upon which the licensed software is installed
Downloaded Software	any software downloaded from an Aeroflex web site
Embedded Software	Licensed Software that forms part of the Equipment supplied by Aeroflex and without which the Equipment cannot function
Licence Fee	the consideration ruling at the date of this Agreement for the use of one copy of the Licensed Software on the Designated Equipment
Licensed Software	All and any programs, listings, flow charts and instructions in whole or in part including Add-in, Computer Application, Downloaded and Embedded Software supplied to work with Designated Equipment

2. LICENCE FEE

The Licensee shall pay the Licence Fee to Aeroflex in accordance with the terms of the contract between the Licensee and Aeroflex.

3. TERM

This Agreement shall be effective from the date hereof and shall continue in force until terminated under the provisions of Clause 9.

4. LICENCE

- 4.1 Unless and until terminated, this Licence confers upon the Licensee the non-transferable and non-exclusive right to use the Licensed Software on the Designated Equipment.
- 4.2 The Licensee may not use the Licensed Software on other than the Designated Equipment, unless written permission is first obtained from Aeroflex and until the appropriate additional Licence Fee has been paid to Aeroflex.
- 4.3 The Licensee may not amend or alter the Licensed Software and shall have no right or licence other than that stipulated herein.
- 4.4 The Licensee may make not more than two copies of the Licensed Software (but not the Authoring and Language Manuals) in machine-readable form for operational security and shall ensure that all such copies include Aeroflex's copyright notice, together with any features which disclose the name of the Licensed Software and the Licensee. Furthermore, the Licensee shall not permit the Licensed Software or any part to be disclosed in any form to any third party and shall maintain the Licensed Software in secure premises to prevent any unauthorised disclosure. The Licensee shall notify Aeroflex immediately if the Licensee has knowledge that any unlicensed party possesses the Licensed Software. The Licensee's obligation to maintain confidentiality shall cease when the Licensed Software and all copies have been destroyed or returned. The copyright in the Licensed Software shall remain with Aeroflex. The Licensee will permit Aeroflex at all reasonable times to audit the use of the Licensed Software.
- 4.5 The Licensee will not disassemble or reverse engineer the Licensed Software, nor sub-licence, lease, rent or part with possession or otherwise transfer the whole or any part of the Licensed Software.

5. WARRANTY

- 5.1 Aeroflex certifies that the Licensed Software supplied by Aeroflex will at the time of delivery function substantially in accordance with the applicable Software Product Descriptions, Data Sheets or Product Specifications published by Aeroflex.
 - 5.2 The warranty period (unless an extended warranty for Embedded Software has been purchased) from date of delivery in respect of each type of Licensed Software is:

Embedded Software	12 months
Add-In Application Software	90 days
Computer Application Software	90 days
Downloaded Software	No warranty
 - 5.3 If during the appropriate Warranty Period the Licensed Software does not conform substantially to the Software Product Descriptions, Data Sheets or Product Specifications Aeroflex will provide:
 - 5.3.1 In the case of Embedded Software and at Aeroflex's discretion either a fix for the problem or an effective and efficient work-around.
 - 5.3.2 In the case of Add-In Application Software and Computer Application Software and at Aeroflex's discretion replacement of the software or a fix for the problem or an effective and efficient work-around.
 - 5.4 Aeroflex does not warrant that the operation of any software will be uninterrupted or error free.
-

- 6 The above Warranty does not apply to:
- 6.1 Defects resulting from software not supplied by Aeroflex, from unauthorised modification or misuse or from operation outside of the specification.
 - 6.2 Third party produced Proprietary Software which Aeroflex may deliver with its products, in such case the third party Software Licence Agreement including its warranty terms shall apply.
- 7 The remedies offered above are sole and exclusive remedies and to the extent permitted by applicable law are in lieu of any implied conditions, guarantees or warranties whatsoever and whether statutory or otherwise as to the software all of which are hereby expressly excluded.

8. INDEMNITY

- 8.1 Aeroflex shall defend, at its expense, any action brought against the Licensee alleging that the Licensed Software infringes any patent, registered design, trademark or copyright, and shall pay all Licensor's costs and damages finally awarded up to an aggregate equivalent to the Licence fee provided the Licensee shall not have done or permitted to be done anything which may have been or become any such infringement and shall have exercised reasonable care in protecting the same failing which the Licensee shall indemnify Aeroflex against all claims costs and damages incurred and that Aeroflex is given prompt written notice of such claim and given information, reasonable assistance and sole authority to defend or settle such claim on behalf of the Licensee. In the defence or settlement of any such claim, Aeroflex may obtain for the Licensee the right to continue using the Licensed Software or replace it or modify it so that it becomes non-infringing.
- 8.2 Aeroflex shall not be liable if the alleged infringement:
- 8.2.1 is based upon the use of the Licensed Software in combination with other software not furnished by Aeroflex, or
 - 8.2.2 is based upon the use of the Licensed Software alone or in combination with other software in equipment not functionally identical to the Designated Equipment, or
 - 8.2.3 arises as a result of Aeroflex having followed a properly authorised design or instruction of the Licensee, or
 - 8.2.4 arises out of the use of the Licensed Software in a country other than the one disclosed to Aeroflex as the intended country of use of the Licensed Software at the commencement of this Agreement.
- 8.3 Aeroflex shall not be liable to the Licensee for any loss of use or for loss of profits or of contracts arising directly or indirectly out of any such infringement of patent, registered design, trademark or copyright.

9. TERMINATION

- 9.1 Notwithstanding anything herein to the contrary, this Licence shall forthwith determine if the Licensee:
- 9.1.1 As an individual has a Receiving Order made against him or is adjudicated bankrupt or compounds with creditors or as a corporate body, compounds with creditors or has a winding-up order made against it or
 - 9.1.2 Parts with possession of the Designated Equipment.
- 9.2 This Licence may be terminated by notice in writing to the Licensee if the Licensee shall be in breach of any of its obligations hereunder and continue in such breach for a period of 21 days after notice thereof has been served on the Licensee.
- 9.3 On termination of this Agreement for any reason, Aeroflex may require the Licensee to return to Aeroflex all copies of the Licensed Software in the custody of the Licensee and the Licensee shall, at its own cost and expense, comply with such requirement within 14 days and shall, at the same time, certify to Aeroflex in writing that all copies of the Licensed Software in whatever form have been obliterated from the Designated Equipment.

10. THIRD PARTY LICENCES

The software or part thereof may be the proprietary property of third party licensors. In such an event such third party licensors (as referenced on the package or the Order Acknowledgement) and/or Aeroflex may directly enforce the terms of this Agreement and may terminate the Agreement if the Licensee is in breach of the conditions contained herein.

11. EXPORT REGULATIONS

The Licensee undertakes that where necessary the Licensee will conform with all relevant export regulations imposed by the Governments of the United Kingdom and/or the United State of America.

12. NOTICES

Any notice to be given by the Licensee to Aeroflex shall be addressed to:
Aeroflex International Limited, Longacres House, Six Hills Way, Stevenage, SG1 2AN, UK.

13. LAW AND JURISDICTION

This Agreement shall be governed by the laws of England and shall be subject to the exclusive jurisdiction of the English courts. This agreement constitutes the whole Contract between the parties and may be changed only by memorandum signed by both parties.

© AEROFLEX INTERNATIONAL LTD 2004

**CHINA Beijing**

Tel: [+86] (10) 6539 1166
Fax: [+86] (10) 6539 1778

CHINA Shanghai

Tel: [+86] (21) 5109 5128
Fax: [+86] (21) 5150 6112

FINLAND

Tel: [+358] (9) 2709 5541
Fax: [+358] (9) 804 2441

FRANCE

Tel: [+33] 1 60 79 96 00
Fax: [+33] 1 60 77 69 22

GERMANY

Tel: [+49] 8131 2926-0
Fax: [+49] 8131 2926-130

HONG KONG

Tel: [+852] 2832 7988
Fax: [+852] 2834 5364

INDIA

Tel: [+91] 80 5115 4501
Fax: [+91] 80 5115 4502

KOREA

Tel: [+82] (2) 3424 2719
Fax: [+82] (2) 3424 8620

SCANDINAVIA

Tel: [+45] 9614 0045
Fax: [+45] 9614 0047

SPAIN

Tel: [+34] (91) 640 11 34
Fax: [+34] (91) 640 06 40

UK Burnham

Tel: [+44] (0) 1628 604455
Fax: [+44] (0) 1628 662017

UK Stevenage

Tel: [+44] (0) 1438 742200
Fax: [+44] (0) 1438 727601
Freephone: 0800 282388

USA

Tel: [+1] (316) 522 4981
Fax: [+1] (316) 522 1360
Toll Free: (800) 835 2352

As we are always seeking to improve our products, the information in this document gives only a general indication of the product capacity, performance and suitability, none of which shall form part of any contract. We reserve the right to make design changes without notice.

web www.aeroflex.com

Email info-test@aeroflex.com

November 2005

